



Prince George's County

# Stormwater Management Design Manual



Department of Permitting, Inspections and Enforcement

September 2014

<b>Chapter 1 INTRODUCTION</b>	<b>1-1</b>
1.1 Background .....	1-1
1.2 Introduction .....	1-1
1.3 General Provisions .....	1-2
1.4 Purpose .....	1-2
1.5 Chapter Overview .....	1-4
1.6 Chesapeake Bay Critical Area .....	1-5
1.7 Maintenance and Inspection Monitoring of Constructed Facilities .....	1-5
1.8 General Permit for Stormwater Associated with Construction Activity .....	1-5
1.9 NPDES Phase 1 MS4 Permit .....	1-6
1.10 TMDL .....	1-6
1.11 Phase II Watershed Implementation Plan .....	1-7
<b>Chapter 2 REPORT AND PLAN STANDARDS</b>	<b>2-1</b>
2.1 General .....	2-1
2.2 General Plan Standards .....	2-1
2.2.1 All Standards .....	2-2
2.2.2 Digital Drawings .....	2-4
2.2.3 Hand Drafting .....	2-4
2.2.4 Other .....	2-4
2.3 Cover Sheet .....	2-5
2.4 Scales and Bar Scale .....	2-5
2.5 Plan Notes .....	2-5
2.5.1 Label Notes .....	2-6
2.5.2 Descriptive Notes .....	2-6
2.5.3 General/Specification Notes .....	2-6
2.5.4 Certifications .....	2-7
2.5.5 Miscellaneous Lettering .....	2-7
2.6 Legends .....	2-8
2.7 Plan Dimensioning and Leaders .....	2-8
2.8 Sections .....	2-10
2.9 Channel Profiles .....	2-11
2.10 Details .....	2-12
2.11 Reports .....	2-12
2.11.1 Summary Tables .....	2-12
2.11.2 Graphs, Charts, and Tables .....	2-13
2.11.3 Appendices .....	2-13
<b>Chapter 3 PERMIT PROCESSING</b>	<b>3-1</b>
3.1 Stages of Plan and Permit Review .....	3-1
3.1.1 Plan and Permit Applications and Fees .....	3-3
3.1.2 Phase One - Land Development Concept Stage Approvals .....	3-5
3.1.3 Phase Two - Land Development Entitlement Approvals .....	3-10
3.1.4 Phase Three - Land Development Final Approvals and Permits .....	3-11

---

3.2	Plan and Permit Revisions .....	3-17
3.3	Updating of an Approved Plan.....	3-17
3.4	Special Drain Permits .....	3-17
3.5	As-Built Plan Approval .....	3-18
3.6	Other Agency Permits and Coordination.....	3-18
 <b>Chapter 4 100-YEAR FLOODPLAIN</b>		<b>4-1</b>
4.1	Introduction .....	4-1
4.2	Authority of Jurisdiction.....	4-1
4.2.1	Prince George’s County.....	4-1
4.2.2	FEMA Program.....	4-2
4.3	Acceptable Studies .....	4-3
4.4	Allowable Floodplain Impacts .....	4-4
4.5	Permitting Floodplain Impacts .....	4-5
4.6	Delineation of Floodplain - GIS-based Floodplain Submittals .....	4-5
4.7	Delineation of Floodplain - Previously Approved Studies:.....	4-7
4.8	Delineation of Floodplain - FEMA Floodplains.....	4-7
4.9	Delineation of Floodplain - Private Consultant Engineering Studies .....	4-7
4.9.1	Data Required for Private Consultant Engineering Studies .....	4-9
4.9.2	Conservative 100 Year Floodplain Delineation .....	4-19
4.10	Floodplain Fill.....	4-20
4.11	Floodplain Buffer .....	4-20
4.12	Floodplain Easements.....	4-21
4.13	Floodplain and Net Tract Area .....	4-21
 <b>Chapter 5 SITE DEVELOPMENT CONCEPT PLAN</b>		<b>5-1</b>
5.1	Purpose, Jurisdiction, and Process.....	5-1
5.1.1	Purpose and Jurisdiction.....	5-1
5.1.2	The MDE’s Three-Phase Comprehensive Review Process.....	5-1
5.1.3	First Phase – Site Development Concept Plan .....	5-2
5.1.4	Exemptions.....	5-3
5.1.5	Variance.....	5-4
5.1.6	Standard Concept Plan.....	5-5
5.1.7	Alternate Requirements for Chesapeake Bay Critical Area.....	5-5
5.1.8	Administrative Waivers and Exemptions .....	5-6
5.2	Concept Design Phase – Definition, Design Guidance, Planning Steps.....	5-8
5.2.1	ESD – Definition.....	5-8
5.2.2	ESD - Design Guidance .....	5-8
5.2.3	Concept Design Phase Planning Steps.....	5-10
5.2.4	Minimum Stormwater Control Requirements and Sizing .....	5-14
5.2.5	Public / Private Maintenance.....	5-20
5.2.6	Existing Off-site Erosion/Flooding/Conveyance Problems .....	5-21
5.2.7	Redevelopment.....	5-24
5.3	SDCP Preparation .....	5-28
5.3.1	Submittal Requirements.....	5-28

---

5.3.2	Site Development Concept Plan:.....	5-29
5.3.3	Site Development Concept Plan - Report Requirements.....	5-30
5.4	Public Maintenance versus Private Maintenance.....	5-36
5.5	Public Notification .....	5-36
5.6	SDCP Validity/Extensions/Revisions.....	5-37
5.7	Application Form .....	5-38
 <b>Chapter 6 SITE DEVELOPMENT PLAN</b>		<b>6-1</b>
6.1	Purpose, Jurisdiction and Process.....	6-1
6.1.1	Purpose.....	6-1
6.1.2	Process - Submittal Procedures Site Development Plan .....	6-1
6.1.3	Process - Review Time Frames for SDP .....	6-2
6.2	SDP Preparation .....	6-3
6.2.1	SWM Design .....	6-3
6.2.2	Erosion and Sediment Control Design/Overlay Plan .....	6-4
6.2.3	Submittal Requirements.....	6-4
6.3	SDP Validity, Extensions, and Revisions.....	6-5
 <b>Chapter 7 FINAL PLAN</b>		<b>7-1</b>
7.1	Purpose and Jurisdiction.....	7-1
7.2	Final Plan Phase (SWM & Storm Drain) - .....	7-3
7.2.1	Site Development Rough Grading Permit (SDRG) .....	7-3
7.2.2	SDFG Permit .....	7-6
7.2.3	Street Construction Permit.....	7-8
7.2.4	Other Approvals or Permits .....	7-10
7.3	Final Design Plans.....	7-11
7.4	Submittal of Plan Drawings and Documents.....	7-11
7.5	Permitting Requirements and Fees.....	7-12
7.6	Final Plan Validity, Extensions, and Revisions.....	7-12
7.6.1	Permit Validity .....	7-12
7.6.2	Extensions to Approved Permits .....	7-13
7.6.3	Changes to Approved Storm Drain/Stormwater Technical Plans .....	7-14
 <b>Chapter 8 STORM DRAIN DESIGN CRITERIA</b>		<b>8-1</b>
8.1	Storm Drain Design Plan Criteria .....	8-1
8.1.1	Introduction .....	8-1
8.1.2	Ordinance and Authority.....	8-1
8.1.3	Definitions.....	8-1
8.2	Hydrologic Computations for Design Conveyance Systems.....	8-2
8.2.1	Rational Method.....	8-2
8.2.2	Time of Concentration (Tc).....	8-5
8.2.3	Rainfall Intensity .....	8-10
8.2.4	NRCS Method.....	8-10
8.3	Storm Drainage Conveyance Criteria .....	8-11

8.3.1	General.....	8-11
8.3.2	Utilities.....	8-11
8.3.3	Closed System Design Criteria.....	8-14
8.3.4	Hydraulic Gradient.....	8-23
8.3.5	Inlet and Manholes .....	8-30
8.3.6	Roadside Ditches.....	8-41
8.3.7	Outfalls .....	8-44
8.3.8	Drainage Swales and Surface Drainage Easements .....	8-50
8.3.9	Sump Pump Discharges.....	8-51
8.4	Ditches and Open Channel Systems.....	8-51
8.4.1	Computations .....	8-51
8.4.2	Velocities .....	8-53
8.4.3	Open Channel Design Criteria .....	8-54
8.4.4	Designed Open Channe .....	8-55
8.4.5	Design Depth .....	8-57
8.5	Bridges and Culverts .....	8-59
8.5.1	Classification and Review.....	8-60
8.5.2	Waterway Openings for Culverts and Bridges.....	8-60
8.5.3	Types of Inlet and Outlet Stabilization for All Structures.....	8-63
8.6	COMPUTER SOFTWARE.....	8-65
8.6.1	Hydrologic Software:.....	8-65
8.6.2	Bridge and Culvert Software .....	8-65

<b>Chapter 9</b>	<b>STRUCTURAL PRACTICES DESIGN CRITERIA</b>	<b>9-1</b>
9.1	Definition of Structural Practices.....	9-1
9.2	Grandfathering Provisions and Administrative Waivers.....	9-1
9.3	Approval Authority.....	9-1
9.3.1	DPIE .....	9-2
9.3.2	PGSCD .....	9-2
9.3.3	MDE .....	9-2
9.3.4	Municipalities .....	9-2
9.3.5	M-NCPPC.....	9-3
9.3.6	Federal and State Projects .....	9-3
9.4	Submittal Requirements.....	9-3
9.5	Maintenance Considerations/Responsibilities.....	9-3
9.6	Structural BMPs - General Design Criteria.....	9-4
9.6.1	H&H Computations for Stormwater Management .....	9-4
9.6.2	ESD <sub>v</sub> , WQ <sub>v</sub> , CP <sub>v</sub> sizing.....	9-5
9.6.3	Overbank Flood Protection (10-Year) Sizing.....	9-6
9.6.4	Extreme Flood Protection (100-Year) Sizing.....	9-6
9.6.5	BMP Summary Table.....	9-6
9.6.6	Easements.....	9-6
9.7	Structural BMPs.....	9-7
9.7.1	Ponds .....	9-7
9.7.2	Structural BMPs - Underground Attenuation Facilities .....	9-21
9.7.3	Stormwater Filtering Systems .....	9-26

---

9.7.4.	Structural BMPs – Infiltration Devices.....	9-29
9.8	Other Structural Devices.....	9-33
9.8.1	Hydrodynamic Water Quality Separators.....	9-33
9.8.2	Other Proprietary Devices Approved by MDE.....	9-35
<b>Chapter 10 ENVIRONMENTAL SITE DESIGN (ESD) CRITERIA</b>		<b>10-1</b>
10.1	Process – Phase Three – Final Plan.....	10-1
10.2	Definition of ESD Practices.....	10-1
10.3	Public/Private Definition and Maintenance.....	10-2
10.4	Approval Authority, Process and Permitting.....	10-2
10.4.1	Approval Authority.....	10-2
10.4.2	DPIE.....	10-2
10.4.3	PGSCD.....	10-3
10.4.4	Municipalities.....	10-3
10.4.5	M-NCPPC.....	10-3
10.4.6	Federal and State Projects.....	10-3
10.5	BMPs – General Design Criteria.....	10-3
10.5.1	Computations.....	10-3
10.5.2	ESD <sub>v</sub> , WQ <sub>v</sub> , CP <sub>v</sub> sizing.....	10-4
10.5.3	Overbank Flood Protection Q <sub>P</sub> (10-Year) Sizing.....	10-6
10.5.4	Extreme Flood Protection Q <sub>F</sub> (100-Year) Sizing.....	10-6
10.5.5	Geotechnical Analysis.....	10-6
10.5.6	BMP - Summary Table.....	10-8
10.5.7	Easements.....	10-9
10.6	Nonstructural BMPs - Alternative Surfaces (A-1, A-2, A-3).....	10-10
10.6.1	Green Roof.....	10-10
10.6.2	Permeable Pavement (A-2).....	10-12
10.6.3	Reinforced Turf (A-3).....	10-14
10.7	Nonstructural BMPs – Nonstructural Practices (N-1, N-2, N-3).....	10-15
10.7.1	Disconnection of Rooftop Runoff (N-1).....	10-16
10.7.2	Disconnection of Non-Rooftop Runoff (N-2).....	10-17
10.7.3	Sheet Flow to Conservation Areas (N-3).....	10-20
10.8	Micro-scale Practices (M-1 through M-9).....	10-21
10.8.1	Rainwater Harvesting (M-1).....	10-22
10.8.2	Submerged Gravel Wetlands (M-2).....	10-24
10.8.3	Landscape Infiltration (M-3).....	10-28
10.8.4	Infiltration Berms (M-4).....	10-31
10.8.5	Dry Wells (M-5).....	10-33
10.8.6	Micro Bio retention (M-6).....	10-36
10.8.7	Rain Gardens (M-7).....	10-41
10.8.8	Swales (M-8).....	10-45
10.8.9	Enhanced Filters (M-9).....	10-49

<b>Chapter 11 EASEMENTS AND RIGHTS-OF-WAY</b>	<b>11-1</b>
11.1 Introduction .....	11-1
11.1.1 Storm Drain Easements .....	11-1
11.1.2 SWM Easements .....	11-3
11.1.3 Surface Drainage Easements .....	11-4
11.1.4 Floodplain Easements.....	11-4
11.1.5 Woodland Conservation Easement .....	11-6
11.1.6 Access and Grading Easement/Letter of Permission .....	11-6
11.1.7 Easement or Right-of-Way Release/Vacation .....	11-6
11.1.8 Easements on Lands Owned by County.....	11-8
11.2 Easement and Right-of-Way Submission Requirements.....	11-10
11.2.1 Dedication of Right-of-Way to the County .....	11-11
11.2.2 Impacts to County Property .....	11-12
11.3 Document Processing Procedures .....	11-13
11.4 Fee Simple Deed (dedication) Processing Procedures .....	11-14
11.5 Revision to Existing Easements.....	11-15
11.6 Declaration of Covenants.....	11-16
11.7 Quit Claim Deed.....	11-16
11.8 Permitting Requirements .....	11-16
<b>Chapter 12 BOND PROCESSING AND BOND RELEASE</b>	<b>12-1</b>
12.1 Introduction .....	12-1
12.2 Construction Cost Estimates.....	12-1
12.3 Bonding General Instructions.....	12-1
12.4 Municipal Bond .....	12-2
12.5 DPIE Bonding .....	12-2
12.6 Requirements for Bond Submittal .....	12-3
12.7 Partial Bond Release .....	12-4
12.8 Bond Release.....	12-4
12.9 Change of Permit Application Responsibility .....	12-5
12.10 Modify or Change Permittee .....	12-6
<b>Chapter 13 QUALITY ASSURANCE</b>	<b>13-1</b>
13.1 Objective	<b>13-1</b>
13.2 Suppliers.....	13-1
13.3 Approved Material .....	13-1
13.4 Materials Release and Certifications .....	13-1
13.5 Shop Drawing Submittal and Processing Requirements.....	13-2
13.6 Site Inspections.....	13-3
13.7 Site Storage and Stockpile .....	13-3
13.8 Plant Inspections .....	13-3
13.9 New SWM Practices Technology / Innovative Practices:.....	13-3

<b>Chapter 14 CONSTRUCTION INSPECTION AND ENFORCEMENT</b>	<b>14-1</b>
14.1 Purpose.....	14-1
14.2 Scope.....	14-1
14.3 Authority and Responsibilities.....	14-1
14.3.1 SWM DPIE Site/Road Inspectors.....	14-1
14.3.2 Coordination among County and Other Inspectors.....	14-2
14.3.3 Inspection Responsibilities.....	14-2
14.3.4 Ponds Approved by Prince George’s Soil Conservation District.....	14-4
14.3.5 Field Inspection Report.....	14-4
14.3.6 Notice of Violation and Stop Work Order.....	14-5
14.3.7 Civil Citations.....	14-6
14.4 Complaints.....	14-7
14.5 Project Default.....	14-7
14.6 Suspension/Revocation of Permit.....	14-8
14.7 General Inspection Requirements during Construction.....	14-9
14.7.1 Guidelines.....	14-9
14.7.2 Field Changes.....	14-9
14.7.3 Required Stormwater Management Procedures and Inspections.....	14-9
14.7.4 Final Acceptance.....	14-10
14.8 General Inspection Measures.....	14-10
14.8.1 Structural Measure Inspection Requirements.....	14-13
14.8.2 Retention or Detention Pond (MDE Devices P1 to P5 and W1 to W4).....	14-14
14.8.3 Infiltration Trench (MDE Device I-1).....	14-17
14.8.4 Surface Sand Filter (MDE Device F-1).....	14-17
14.8.5 Underground Sand Filter (MDE Device F-2).....	14-18
14.8.6 Bio retention Systems (MDE Device F-6).....	14-18
14.8.7 Underground Detention System.....	14-19
14.8.8 Hydrodynamic Separator.....	14-20
14.9 Inspection Requirements for Nonstructural ESD Practices.....	14-20
14.9.1 Alternative Surfaces.....	14-20
14.9.2 Nonstructural Practices.....	14-22
14.9.3 Microscale Practices.....	14-20
<b>Chapter 15 AS-BUILT PLANS</b>	<b>15-1</b>
15.1 Administrative Procedures for Submitting As-Built Plans.....	15-1
15.2 Information Presentation.....	15-3
15.3 As-Built Plan.....	15-3
15.4 Delivery Tickets.....	15-6



This Page Intentionally Left Blank

## List of Tables

Schedule 3-1 Stormwater Management Fee-in-Lieu .....	3-8
Table 4-1 Agency Responsible for Providing Floodplain Data to the Public .....	4-4
Table 5-1 Outfall Considerations .....	5-14
Table 8-1 Rational Method Runoff Coefficient .....	8-3
Table 8-2 Runoff Correction Factor .....	8-5
Table 8-3 Recommended “n” Values for Use with Chart MSHA-61.1-402.1 .....	8-9
Table 8-4 Pipe Material Type and Abbreviations .....	8-14
Table 8-5 Manning’s Roughness Coefficients for Pipe .....	8-15
Table 8-6 Elliptical Pipe versus Circular Pipe Equivalencies .....	8-18
Table 8-7 Frequencies for Coincidental Occurrence .....	8-29
Table 8-8 MSHA Grates .....	8-34
Table 8-9 DPIE Standard Inlets .....	8-35
Table 8-10 Riprap Classification .....	8-45
Table 8-11 Limiting Velocities for Ditches and Channels .....	8-54
Table 8-12 Manning’s Roughness Coefficients for Manmade Channels .....	8-57
Table 10-1 ESD Device Geotechnical Determination .....	10-7
Table 10-2 ESD <sub>v</sub> Provided by Green Roof .....	10-11
Table 10-3 ESD <sub>v</sub> Provided by Permeable Pavement Storage Media .....	10-14
Table 11-1 Permanent Easement Width for Storm Drain Pipe Installation .....	11-2

## List of Figures

Figure 2-1 Extension Line Gap .....	2-8
Figure 2-2 Staggered Dimensions .....	2-9
Figure 2-3 Breaks in Extension Lines for Other Extension Lines .....	2-9
Figure 2-4 Grouping of Dimensions .....	2-10
Figure 2-5 Reading Direction .....	2-10
Figure 8-1 Hydraulic Grade Profile Example .....	8-25
Figure 8-2 Pipe Angle Example .....	8-26
Figure 8-3 Bicycle Safe Grate Options .....	8-34
Figure 8-4 Curb Cross Section .....	8-37
Figure 8-5 Culvert Skew Length .....	8-62
Figure 8-6 Culvert Skew Length for Different Size Pipes .....	8-63

This Page Intentionally Left Blank

Website Links

**CHAPTER 1 INTRODUCTION**

<a href="#">Maryland Design Manual</a>	1-2
<a href="#">COMAR Title 26 Search</a>	1-2
<a href="#">Council Bill 15-2011</a>	1-3
<a href="#">Critical Area 10% Rule Guidance Manual</a>	1-5
<a href="#">PGAtlas</a>	1-5
<a href="#">Chesapeake Bay Critical Area Commission</a>	1-5
<a href="#">General Permit for Stormwater Associated with Construction Activity</a>	1-6
<a href="#">Prince George's County MS4 Permit</a>	1-6
<a href="#">MDE TMDL Data Center</a>	1-7
<a href="#">Phase II Watershed Implementation Plan</a>	1-8

**CHAPTER 3 PERMIT PROCESSING**

<a href="#">DPIE Plan/Permit Applications</a>	3-3
<a href="#">DPIE Review Checklists</a>	3-4
<a href="#">Municipal Permitting Responsibilities</a>	3-19

**CHAPTER 4 100-YEAR FLOODPLAIN**

<a href="#">National Flood Insurance Program</a>	4-3
<a href="#">FEMA LOMR Process</a>	4-3
<a href="#">Amendment-Letter-Map-Revision-Based-Fill-Process</a>	4-9
<a href="#">NRCS WinTR-20 Watershed Hydrology</a>	4-10
<a href="#">NRCS Science and Technology Conservation Tools Software</a>	4-11
<a href="#">Prince George's County Soils Survey</a>	4-11
<a href="#">Small Watershed Hydrology NRCS Win TR-55 User Guide</a>	4-11
<a href="#">COE HEC-2 Software Program</a>	4-14
<a href="#">COE Application of HEC-2 Split Flow Options</a>	4-18
<a href="#">COE HEC-RAS 4.1 User's Manual</a>	4-18
<a href="#">COE HEC-RAS 4.1 Applications Guide</a>	4-19
<a href="#">COE HEC-RAS 4.1 Hydraulic Reference Manual</a>	4-19
<a href="#">FEMA Amendment &amp; Letter of Map Revision Based on Fill Process</a>	4-21

**CHAPTER 5 SITE DEVELOPMENT CONCEPT PLAN**

<a href="#">Prince George's County Landscape Manual</a>	5-13
<a href="#">Environmental Technical Manual</a>	5-13
<a href="#">MDE ESD Redevelopment Examples</a>	5-26
<a href="#">PGAtlas Homepage</a>	5-30
<a href="#">TMDL Impaired Watersheds</a>	5-38
<a href="#">Nutrient Impairments and TMDLs</a>	5-38
<a href="#">Prince George's County Tier II Waters</a>	5-39
<a href="#">M-NCPPC Historic Preservation</a>	5-39

**CHAPTER 8 STORM DRAIN DESIGN CRITERIA**

<a href="#">NOAA Atlas 14 Precipitation Frequency Estimates for Maryland</a>	8-9
--	-----

**WEBSITE LINKS**

Issue Date: September 30, 2014

---

<a href="#">NRCS Hydrology &amp; Hydraulics Tools</a>	8-9
<a href="#">PGSCD Reference Manual</a>	8-10
<a href="#">Prince George's County Soil Survey</a>	8-10
<a href="#">Miss Utility</a>	8-11
<a href="#">Maryland State Law for Miss Utility</a>	8-11
<a href="#">Hydraulic Design of Highway Culverts (HDS No. 5)</a>	8-24
<a href="#">FHWA Urban Drainage Manual HEC-22</a>	8-33
<a href="#">Hydraulic Design of Improved Inlets for Culverts</a>	8-46
<b>CHAPTER 9</b>	<b>STRUCTURAL DEVICES DESIGN CRITERIA</b>
<a href="#">Addressing Quantity Control Requirements</a>	9-7
<a href="#">Maryland's Dam Safety Program</a>	9-9
<b>CHAPTER 10</b>	<b>ENVIRONMENTAL SITE DESIGN (ESD) DESIGN CRITERIA</b>
<a href="#">MDE Environmental Site Design Process &amp; Computation</a>	10-5
<a href="#">MDE Stormwater Design Guidance - Submerged Gravel Wetlands</a>	10-25
<a href="#">Chesapeake Stormwater Network Design Specifications For Multiple Devices</a>	
<b>CHAPTER 13</b>	<b>QUALITY ASSURANCE</b>
<a href="#">MSHA Qualified Producers &amp; Products</a>	13-1
<a href="#">MSHA Qualified Products List (QPL)</a>	13-1
<b>CHAPTER 14</b>	<b>CONSTRUCTION INSPECTION AND ENFORCEMENT</b>
<a href="#">List of Municipalities Inspections</a>	14-3
<b>Other DPIE Document Web links</b>	
<a href="#">Signing and Marking Plan Design Review Checklist</a>	
<a href="#">Street Tree And Lighting Design Review Checklist</a>	
<a href="#">Traffic Signal Design Review Checklist</a>	
<a href="#">Street Grade Establishment Plan Design Review Checklist</a>	
<a href="#">Street Grade Establishment Plan Submittal Checklist</a>	
<a href="#">Maintenance of Traffic Design Review Checklist</a>	
<a href="#">Site Development Rough Grading Permit Submittal Checklist</a>	
<b>Other Agency Web links</b>	
<a href="#">MSHA Access Permits Home Page</a>	
<a href="#">MSHA Highway Design Manual</a>	
<a href="#">MSHA Standard Specifications for Construction and Materials 2008</a>	
<a href="#">MSHA Book of Standards - For Highway &amp; Incidental Structures</a>	
<a href="#">PGSCD Reference Manual</a>	
<a href="#">2011 Maryland Standards and Specifications for Soil Erosion and Sediment Control</a>	
<a href="#">Prince George's Soil Conservation District Home Page</a>	

---

## Appendix List

### **Chapter 2 REPORT AND PLAN STANDARDS**

- 2-1 Standard List of Abbreviations
- 2-2 Sample Note Guidelines - Single and Multiple Columns
- 2-3 Certification Language and Format
- 2-4 Sample Legend Format

### **Chapter 3 PERMIT PROCESSING**

- 3-1 Site Development Concept Plan Flowchart
- 3-2 Site Development Plan Flowchart
- 3-3 Permit Flowcharts
- 3-4 Sample Construction Permits

### **Chapter 4 100-YEAR FLOODPLAIN**

- 4-1 Requesting Existing Floodplain Studies Flowchart
- 4-2 Floodplain Review Process Flowchart
- 4-3 Floodplain Submittal Information Sheet
- 4-3 Sample Floodplain Approval Block

### **Chapter 5 SITE DEVELOPMENT CONCEPT PLAN**

- 5-1 Sample Standard Concept Plan Application
- 5-2 ESD Matrix
- 5-3 BMP Summary Table for a Site Development Concept Plan
- 5-4 Sample Stream Field Inventory
- 5.5 Sample Notification Letter
- 5-6 Sample Affidavit

### **Chapter 6 SITE DEVELOPMENT PLAN**

- 6-1 Sample Approval Letter

### **Chapter 7 FINAL PLAN**

- 7-1 Sample County Approval Blocks
- 7-2 Plan General Notes

### **Chapter 8 STORM DRAIN DESIGN CRITERIA**

- 8-1 Marlboro Clay Soils Investigation Criteria
- 8-2 Overland Flow (MSHA-61.1-402.1)
- 8-3 Swale Flow Grass Chart (MSHA-61.1-402.3)
- 8-4 Swale Flow Paved Chart (MSHA-61.1-402.4)
- 8-5 Ditch Flow Grass Chart (MSHA-61.1-402.5 s)
- 8-6 Ditch Flow Paved Chart (MSHA-61.1-402.6)
- 8-7 Gutter Flow Chart (MSHA-61.1-402.7)
- 8-8 Rational Method Rainfall Intensity Table
- 8-9 Pipe Material Specification Table
- 8-10 Pipe Drain Size Computation Table

- 8-11 Sample Structure Schedule
- 8-12 RCP C-76 Pipe Loading Chart
- 8-13 Sample Pipe Schedule
- 8-14 Head Loss Coefficient MSHA 61-1-408.0
- 8-15 Sample Head Loss Calculation
- 8-16 Sample Head Loss Form
- 8-17 Curb and Gutter Spread Calculation
- 8-18 Prince George's County Inlet Capacity Charts
- 8-19 MSHA Inlet Interception and Efficiency Capacity Chart
- 8-20 MSHA Sample WR and NR Inlet Capacity Chart
- 8-21 Minimum Width of Structures
- 8-22 Rip rap "n" Value Chart
- 8-23 Limiting Velocities for Rip Rap Lining

### **Chapter 9 STRUCTURAL PRACTICES DESIGN CRITERIA**

- 9-1 SWM Landscape Criteria
- 9-2 Wetland Planting Vegetation Guideline
- 9-3 Warning Sign
- 9-4 Storm Drain Discharge into Pond Rip Rap Outfall Options
- 9-5 Guidelines for SWM Facilities to be Located on M-NCPPC Property
- 9-6 Riser Weir and Orifice Flow Scenarios
- 9-7 Riser Location Sketch
- 9-8 Low Flow Pipe Examples
- 9-9 Typical Barrel and Riser Profile
- 9-10 Typical Embankment Cross Section
- 9-11 Emergency Spillway Cross Section and Profile
- 9-12 Geotechnical Testing Requirements for Infiltration Systems
- 9-13 Infiltration Trench Specifications and Notes

### **Chapter 10 ENVIRONMENTAL SITE DESIGN (ESD) DESIGN CRITERIA**

- 10-1 BMP Summary table
- 10-2 Sample BMP Calculations
- 10-3 Infiltration Testing Geotechnical Analysis Requirements
- 10-4 Permeable Pavement Sample Cross Section (A-2), Notes, and Specifications
- 10-5 Reinforced Turf Detail, Notes, and Specifications (A-3)
- 10-6 Dry Well Typical Detail (M-5), Notes, and Specifications
- 10-7 Landscape Criteria

### **Chapter 11 EASEMENTS AND RIGHTS OF WAY**

- 11-1 Easement Processing Flowchart
- 11-2 Easement Width for Multiple Pipes
- 11-3 Channel/Swale Easement Width
- 11-4 Block Easement sketch along road radius
- 11-5 Standard Easement language
- 11-6 Right of Way Conveyance or Abandonment Transmittal
- 11-7 Declaration of Covenants

**Chapter 12 BOND RELEASE AND BOND RELEASE**

- 12-1 Sample Security Forms
- 12-2 Sample Construction Cost Estimate
- 12-3 Office of Law Bond Review Checklist
- 12-4 Sample Acceptance Memo

**Chapter 13 QUALITY ASSURANCE**

- 13-1 Shop Drawing Submittal Form

**Chapter 14 CONSTRUCTION INSPECTION AND ENFORCEMENT**

- 14-1 Sample Inspection Report
- 14-2 Inspection Flowchart
- 14-3 Sample Punch List
- 14-4 Multiple Inspection Check-Off Lists



This Page Intentionally Left Blank

---

## Chapter 1 INTRODUCTION

### 1.1 Background

The primary goal of the State of Maryland's Stormwater Management (SWM) program is to maintain, as nearly as possible, an area's predevelopment runoff characteristics after development has occurred. A comprehensive design strategy for maintaining predevelopment runoff characteristics and protecting natural resources known as Environmental Site Design or ESD, relies on integrating site design, natural hydrology, and more numerous, but smaller control devices to capture and treat runoff.

Traditional SWM strategies treat runoff to mitigate some adverse water quality and/or quantity impacts associated with new development. A design applying these strategies often combines centralized structural practices for pollutant removal with channel erosion or flood control impoundments. These designs are less able to mimic predevelopment conditions because they focus on managing large volumes of storm water rather than treating runoff closer to the source. This manual provides the foundation to refocus storm water design from centralized SWM to more effective planning and ESD implementation.

### 1.2 Introduction

Prince George's County (the County) is providing this manual to guide applicants and their consultant teams in the design of SWM systems that achieve the goals of the County's Water Quality Resources and Grading Code (County Code Sec. 32 - Division 3). Every effort has been made to create a comprehensive guidance document that is technically clear and consistent. Because site conditions will vary, it shall remain the applicant's responsibility to review and verify the applicability of all material presented herein as it pertains to any specific project. If the applicant believes that strict adherence to the established design criteria is not suitable for a particular situation, a variance (County Code Sec. 32-176) may be requested.

The purpose of this manual revision is to:

- A. Update policy and design parameters pertaining to storm water treatment and conveyance;
- B. Incorporate the Maryland Department of the Environment (MDE) SWM changes from the SWM Act of 2007;
- C. Transfer responsibilities from the Prince George's County Department of Public Works & Transportation (DPW&T) to a new department (the County's Department of Permitting, Inspections and Enforcement (DPIE)); and
- D. Include the updated SWM Ordinance in the County Code.

Some information from this manual was obtained from the latest version of the *2000 Maryland Stormwater Design Manual, Volumes I and II (MDE, 2000 and 2009 (Maryland Design Manual))* or other publications from MDE; minimal changes were made except to incorporate additional

requirements or guidance from the County. The MDE manual may be accessed at [Maryland Design Manual](#).

### 1.3 General Provisions

In order to comply with the SWM Act of 2007 (Environment Article 4-201 and 4-203, Annotated Code of Maryland and subsequent regulations issued by MDE under Code of Maryland Regulation (COMAR) 26.17.02, the manual has been updated to comply with the following regulations.

#### [COMAR Title 26 Search](#)

The SWM Act of 2007 requires establishment of a comprehensive process for SWM approval, implementing ESD to the maximum extent practicable (MEP), and ensuring that structural practices described in *Maryland Design Manual* Chapter 3 are used only where absolutely necessary. The Act also establishes several performance standards for SWM plans. In accordance with *Maryland Design Manual* page 5-1, design consultants must now ensure that SWM plans are designed to:

- A. Prevent soil erosion from development projects.
- B. Prevent increases in nonpoint pollution.
- C. Minimize pollutants in storm water runoff from both new development and redevelopment.
- D. Restore, enhance, and maintain chemical, physical, and biological integrity of receiving waters to protect public health and enhance domestic, municipal, recreational, industrial, and other water uses as specified by MDE.
- E. Maintain 100% of the average annual predevelopment groundwater recharge volumes.
- F. Capture and treat storm water runoff to remove pollutants.
- G. Implement a channel protection strategy to protect receiving streams.
- H. Prevent increases in the frequency and magnitude of out-of-bank flooding from large, less frequent storms.
- I. Protect public safety through the proper design and operation of SWM facilities.

### 1.4 Purpose

The intent of the manual, in conjunction with the County Code, is to ensure that all new land development and redevelopment activities, the public improvements projects of various public agencies, and other land impacts are properly reviewed and permitted to result in SWM systems that:

- A. For new land development, replicate, as much as practicable, woods in good condition for the disturbed area.

- 
- B. For redevelopment, establish water quality measures for impervious areas not previously treated.
  - C. Prevent loss of life and significant property damage that would otherwise be caused by major storms.
  - D. Provide an acceptable degree of access and use of property during and following less severe storms.
  - E. Preserve, to the extent possible, desirable natural watercourses and natural habitats.
  - F. Adequately convey storm water flows from upstream sources.
  - G. Mitigate the adverse effects of storm water flow on downstream properties.

The manual is also being revised to reflect recent updates to the County's SWM Ordinance, which was modified as County Code Subtitle 32 as part of CB-15-2011 on July 19, 2011.

### Council Bill 15-2011

The shifting of County Code sections from Subtitle 4 and the new additions required by MDE were incorporated in the new Subtitle 32. The subtitle references the County's Department of Public Works and Transportation (DPW&T) as the primary agency responsible for implementing County Code Subtitle 32. Effective July 1, 2013, DPIE was established by the County to administer the program and inherited the responsibilities of the SWM ordinance from DPW&T. DPIE combines the functions of several County departments and is responsible for administering an effective SWM program. Therefore, references in County Code Subtitle 32 to "DPW&T" will be assumed to be DPIE unless otherwise determined by the Director.

The DPIE's SWM responsibilities include approval for planning, design, and construction inspection. This design manual meets part of that responsibility by incorporating the latest policies, procedures, and technologies. Specific changes have been made to incorporate the use of ESD as required by the *Maryland Design Manual*. The overall goals of this manual are to:

- A. Improve practices and standards,
- B. Avoid problems related to grading and drainage,
- C. Promote environmentally sensitive designs,
- D. Minimize maintenance burdens, and
- E. Identify and streamline processes.

In addition to detailing design criteria for storm drain and SWM systems, this manual incorporates the MDE three-phase comprehensive planning and design process, County permitting process and requirements, floodplain study and regulatory process, easement criteria, bonding and permits issuance, construction inspection process, as-built requirements, and release of bonds and permits process.

## 1.5 Chapter Overview

The design manual has 15 chapters that can be broken into several basic categories: Introduction and Plan Standards (Chapters 1 and 2); Permits and Bonds (Chapters 3 and 12); Planning (Chapters 4-7); Design Plans (Chapters 8-11); and Construction (Chapters 13-15).

**Introduction and Plan Standards** – The first chapter introduces the requirements to be met in accordance with State and County law. These requirements include protection of properties, protection of the environment, controlling storm water runoff, and complying with environmental regulations. The second chapter deals with a minimum level of plan or report preparation to provide drawings that are easy to read and understand by review staff, contractors, and inspection staff. Applicants should also strive to provide better documentation for the proposed project for use by the design consultant, County staff, and the public to better understand the approach taken and the goals of the project.

**Permits and Bonds** – The permit section outlines the various types of permits that can be obtained, the basic procedures for applying for a permit, and the respective permit fees. The bond chapter covers the County’s processing activities and how bonds are reviewed, approved, and released.

**Planning** – This part of the manual outlines the information to be provided to the County to determine the measures needed to meet the requirements of Subtitle 32. Chapter 4 establishes the requirements for floodplain delineations and how to mitigate possible impacts to the floodplain. Chapter 5 includes Site Development Concept Plan preparation, which establishes ESD to the MEP for new and redevelopment projects and is the first phase of the three-phase process required by MDE. The Site Development Plan (Chapter 6) outlines the review requirements based on final layout and includes computations for evaluating whether a design meets ESD to the MEP. Lastly, Chapter 7 covers the several options for obtaining a plan approval or construction permit and includes the limitations and steps required to obtain the necessary permits to commence construction.

**Design Plans** – The Design Plans consist of four chapters that provide the necessary information for construction drawings to be approved by the County. Chapter 8 covers the design of storm drain systems for both open-section and closed-section roadways. This includes information to ensure appropriate detail is provided for sizing of pipes and structures for the design storms. Chapter 9 deals with “structural” SWM facilities including ponds and other types of devices identified by MDE. Chapter 10 covers the design requirements for ESD or “nonstructural” devices required by MDE per the SWM Act of 2007. Lastly, Chapter 11 deals with size, location, and requirements for submitting rights-of-way or easements, as well as associated review procedures and recording of the easement document.

**Construction** – The construction portion of this manual provides procedures to follow for the installation of storm drains and SWM, including all water quality facilities. Chapter 13 contains information on proper materials to use for construction. Chapter 14 provides specific procedures to follow during construction. Chapter 15 provides information on the need and requirements for submitting as-built drawings for County approval.

## 1.6 Chesapeake Bay Critical Area

In Prince George's County, the Chesapeake Bay Critical Area (CBCA) extends along the Patuxent, Potomac, and Anacostia Rivers. In order to accommodate already existing land uses and growth within the County's CBCA, while still providing for the conservation of habitat and the protection of water quality, the County has identified and mapped three overlay zones within the CBCA. The three overlay zones are:

- A. Resource Conservation Overlay Zone
- B. Limited Development Overlay Zone
- C. Intensely Developed Overlay Zone

The overlay zones require nutrient reduction; the computations for achieving the goal is described in the *Maryland Chesapeake and Atlantic Coastal Bays Critical Area 10% Rule Guidance – Fall 2003*. The document may be found at the following website:

[Critical Area 10% Rule Guidance Manual](#)

To determine if a property is in the CBCA and to find the designated zones, see the Maryland-National Capital Park and Planning Commission (M-NCPPC) website:

[PGAtlas](#)

Additional guidance publications provided by the State's Critical Area Commission may be found on its website:

[Chesapeake Bay Critical Area Commission](#)

## 1.7 Maintenance and Inspection Monitoring of Constructed Facilities

The County's Department of Environment (DOE) is responsible for reporting to the State the status of constructed facilities once permits have been released. Generally, this requires the property owner to submit reports or documentation that the storm water device on their property is operating properly. The "property owner" may include other county agencies, public agencies such as the M-NCPPC, or the Washington Suburban Sanitary Commission (WSSC), as well as private property owners. Depending upon the complexity of the device, different maintenance and inspection requirements may be necessary. Information located on the DOE website provides appropriate maintenance, inspection, device monitoring, and reporting requirements. Information on the maintenance and inspection reporting requirements may be found in the Department of Environmental Resources (DER) publication, *Stormwater Best Management Practices Inspection Manual*, July 2009.

## 1.8 General Permit for Stormwater Associated with Construction Activity

Developers of projects that will disturb one or more acres of earth must obtain coverage under a General Permit for Stormwater Associated with Construction Activity before beginning earth disturbance on any part of the project. However, projects that will disturb 150 acres or more and discharge to a water body listed as impaired on Maryland's 303(d) list must apply for an

individual permit. The MDE may later determine that an individual permit is required for some projects applying for the General Permit. All applicants may use the same form whether applying for an individual or a general permit.

Projects that initially disturb less than one acre, but are part of a plan of development that will ultimately disturb one acre or more, must also obtain a General or Individual Permit for Stormwater Associated with Construction Activity before the initial earth disturbance.

The applicant is responsible for obtaining the National Pollutant Discharge Elimination System (NPDES) permit based on criteria established by the State. Prince George's County does not require this permit for issuance of any County permit. However, once disturbance of land is ready to proceed, the County inspector will verify that an NPDES permit has been issued for the site. The State website with additional information, including the application, is:

[General Permit for Stormwater Associated with Construction Activity](#)

### 1.9 NPDES Phase 1 MS4 Permit

The NPDES Municipal Separate Storm Sewer System Discharge Permit (MS4) is a conveyance system or system of conveyances including roads with drainage systems, municipal streets, catch basins, curb, gutters, ditches, manmade channels, or storm drains that are owned and operated by the County or a City, Town, Association, or public body. These systems include special districts, flood control districts, or drainage districts that discharge storm water to waters of the State and the United States. The County falls under a Large MS4 regulated area based on its population of greater than 250,000. Some land use activities, including industrial operations, may require a separate MS4 discharge permit for the State. The County must manage, implement, and enforce a storm water management program (SWMP) in accordance with the Clean Water Act (CWA) and corresponding NPDES storm water regulations found in Title 40 Code of Federal Regulations (CFR) Part 122, in order to meet the following requirements:

- Effectively prohibit pollutants in storm water discharges or other unauthorized discharges through the County's Illicit Discharge Detection and Elimination inspection program as necessary to comply with the State's receiving water quality standards;
- Attain applicable Waste Load Allocations (WLAs) for each established or approved Total Maximum Daily Load (TMDL) for each receiving water body; and
- Comply with all other provisions and requirements contained in the permit, plans, and schedules developed in fulfillment of the permit.

[Prince George's County MS4 Permit](#)

### 1.10 TMDL

In January 2014, the MDE issued a new MS4 permit to the County. The permit requires that the County submit a restoration plan for each "local" storm water WLA from a U.S. Environmental Protection Agency (EPA)-approved TMDL in the County. For these local TMDLs, the restoration plans must be submitted to MDE within 1 year of permit issuance. For TMDLs not

approved at the time of the permit issuance, the restoration plans must be submitted within 1 year of EPA approval of the TMDL. The plans are to include restoration efforts for urban storm water practices toward meeting only the WLA that was assigned to the County's MS4 permit. Information on existing TMDLs and WLAs may be found on the MDE website below.

[MDE TMDL Data Center](#)

The restoration plans for local TMDLs are currently under development. As per permit requirements, the plans will include a schedule and cost estimate for implementing water quality improvement practices, methods to track restoration plan progress, and a description of an interactive process to evaluate restoration progress and create alternative strategies when necessary. The new permit also identifies specific requirements regarding the Anacostia River Trash TMDL; therefore, these specific requirements will be included in the local implementation plan for the Trash TMDL.

### 1.11 Phase II Watershed Implementation Plan

The EPA ruled that the 30 years of voluntary efforts by States to clean up the Chesapeake Bay were too slow to achieve recovery progress. To address this, EPA established further regulatory mandates (TMDLs) with timelines for States and the County. As the first step, EPA developed a TMDL and required all States to develop a Phase I Watershed Implementation Plan that proposes load reduction strategies (nitrogen, phosphorus, and sediments) at a State-wide scale to meet the TMDL load reduction goals.

The State has further distributed the bay load allocations at a jurisdictional scale (County), and requested that the County develop its own watershed implementation strategy to reduce its load allocations.

For the County, this plan is known as the Phase II Watershed Implementation Plan (WIP-II), which includes four source sectors: wastewater treatment plants, septic systems, agriculture, and urban storm water runoff. The WIP-II Plan presents the necessary strategies to reduce the discharge of phosphorous, nitrogen, and suspended solids. In general, this program is coordinated between the County and MDE under the auspices of the EPA.

For urban storm water runoff, the WIP-II focuses on retrofit efforts to existing developments that do not have SWM controls in place. The MDE and EPA require the County to reduce 60% of the required TMDL pollutant load reductions by 2017 and 100% of the TMDL load reduction by 2025. Consequently, the County will need to retrofit approximately 8,000 acres of untreated impervious areas within its urban areas by 2017, and to retrofit another 7,500 impervious acres by 2025.

New development/redevelopment controls are mostly under the umbrella of the County's SWM Ordinance, but additional requirements will be governed by the State's "Accounting for Growth" policy.

[Phase II Watershed Implementation Plan](#)



This Page Intentionally Left Blank

---

## Chapter 2 REPORT AND PLAN STANDARDS

### 2.1 General

Chapter 2 details the required formatting, layout, and presentation of design drawings and computations for the review and approval of SWM plans. All technical plans for submittal to the County's DPIE, Site/Road Plan Review Section must be produced on clean 24- by 36-inch sheets that can be clearly duplicated and scanned in a pdf file format. The final permit drawings must be on mylar and accompanied with electronic computer aided design and drafting project files. Presenting design information that is legible to the reviewer, inspector, and contractor is of extreme importance. A properly designed plan that is poorly organized or has multiple text styles or sizes with various line weights too often results in additional reviews. It also can cause confusion in the field because the inspector or contractor cannot interpret the plan and must contact the design consultant to clarify the design's intent. This delays implementation of the design.

A drawing is a means of conveying and recording information. The information should not only be correct, but also arranged and referenced in a fashion that allows easy interpretation. Construction drawings shall be complete with respect to dimensions and sizes of materials, resulting in minimum reference to the specifications. Finished drawings must be prepared so copies and reductions to smaller scales will be clear and legible. Careful consideration should be given to the line weights and values and the accuracy, style, and position of all notations. In particular, text on top of text or line work that obscures design information needs to be minimized or eliminated.

Often the use of different line weight, size, or height is an attempt by the designer to emphasize a note or detail. However, as more notes are added and deemed important, the larger size and/or line weight becomes standard. This obscures the normal information that is the basis of the design. The use of large letters without a corresponding increase in line weight can make it more difficult to focus on the very information a designer is trying to present.

Much of the information presented in this chapter is guidance, not a requirement. However, if a specific text or other item is required or if there is a preference such as plan scale, the preferred item will be **bold**. Likewise, if "will" or "shall" is used, it is considered required or mandated. If "should" is used, it is only considered guidance.

### 2.2 General Plan Standards

The basic notes and text on a drawing shall be at least 0.1 inch high (e.g., 10 points). For information such as titles and road names, notes should be increased in size preferably by multiples of 0.05 inch. For example, it would be easy to require all road names to be at least 0.20 inch high; however, with the large amount of information presented on a drawing, adherence to strict guidance is not always possible. This is only considered guidance, and the policy applies to all plans submitted to DPIE. The drawing scale selected should be the largest practical scale, based on the size of the structure, site, and

drawing space available. The following standards should be applied; the suggested scale is shown in bold:

Site Development Concept Plan	1" = 30', 40', and <b>50'</b> ,
Site Development Plan:	1" = 10', 20', or <b>30'</b> , with 2' contours
ESD Facility Enlargement:	1" = 10' or 20'
Drainage Area Map:	1"= <b>50'</b> for ESD devices, 100' or 200' for Storm Drain only with contour intervals of 2'.
Grade Establishment Plan:	1" = 5' vertical; 1" = 50' horizontal
Storm Drain and Paving Plan:	1" = 20' or <b>30'</b>
Maintenance of Traffic Plan:	1" = 30' or 50'
Signing and Marking Plan:	1" = 30' or 40'
Street Light Plan:	Match Storm Drain and Paving Plan
Storm Drain Profiles:	1" = 5' vertical; 1" = 50' horizontal

Stormwater Management:

Cross Sections:	1" = 2', <b>3'</b> , or 5' vertical; 1" = 20', or <b>30'</b> horizontal
Plan:	1" = 10', 20', or <b>30'</b> .
Structure and Section Detail:	Use an architect scale for 1" or fraction thereof = 1' for all structure dimensions. For example, ¼ inch = 1 foot; ½ inch = 1 foot, ¾ inch = 1 foot, etc. It is the preferred practice to show all structure detail dimensions in feet and inches.

With the exception of a Grade Establishment Plan, the use of 1" = 50' for technical drawings is strongly discouraged.

**2.2.1 All Standards**

- A. A 5-inch, full-height open area on the right-hand side of the drawing shall be reserved for County approval blocks. This applies to all plans approved by DPIE.
- B. On the Vicinity Map, the areas of proposed work shall be clearly identified by an arrow and the word "Site." The location of the Vicinity

Map shall generally be in the upper right hand area of the first sheet, outside of the 5-inch area reserved for County approval blocks. Vicinity map scale shall generally be 1" = 2,000', and shall include the WSSC 200-foot sheet number(s) that encompasses the Project Site area and the ADC map book page and grid.

- C. To provide uniformity on drawings, all descriptive statements, notes, and explanations shall be **CAPITALIZED**.
- D. The date when the design drawings were completed shall be shown. The revision block may be used prior to plan approval to track changes.
- E. Coordinates shall be based on the Maryland State Plane Coordinate System and bearings shall be related to true north. Three registration marks or coordinates shall be labeled on each plan view under one of the following options:
  - 1. Place in an L-shaped pattern with the coordinates and plan data located within the L-shaped pattern.
  - 2. Show the coordinate values on at least three property corners.
- F. Unless otherwise approved, the horizontal datum shall be the North American Datum (NAD) of 1983/91 and the vertical datum shall be National Geodetic Vertical Datum of 1929 (NGVD) for all design drawings.
- G. Limits of disturbance/permit shall be clearly and concisely shown on all drawings.
- H. The preference is to orient each plan sheet so the North arrow is generally pointed toward the top or the left side of the sheet. This does not apply to a Grade Establishment Plan.
- I. North arrows shall be shown adjacent to all plan views including inserts, preferably above or to the right of the plan. Plan scale shall also be shown adjacent to the North arrow.
- J. Symbols and line styles shall be in accordance with "Plan Convention Symbols" in County Standard SD 1.0 and 1.1. Wherever symbols fail to satisfactorily convey the requisite information, notes shall be used.
- K. Each drawing prepared shall bear an appropriate drawing and sheet number. An index for drawings shall be shown on the cover sheet if there are more than three sheets.
- L. The drawings shall be arranged in the order below:
  - 1. Cover Sheet

2. Storm Drain and Paving Plan (may include Drainage Area Map)
  3. Stormwater Management Plan (may include Drainage Area Map)
  4. Bridge Plan (if applicable)
  5. Street Tree and Lighting Plan (if applicable)
  6. Signing and Pavement Marking Plan (if applicable)
  7. Traffic Signal Plan (if applicable)
  8. Maintenance of Traffic Plan (if applicable)
- M. Match lines with a minimum length of 4 inches shall identify the matching sheet number and shall be used wherever the plan is to be continued on the same or another sheet.
- N. Duplicate dimensions should be minimized as much as possible.
- O. Provide a Key Map on each plan sheet if there are more than four plan sheets.
- P. Plans will be acceptable only if all line work and lettering are concise, legible, and readily capable of being reproduced.

### **2.2.2 Digital Drawings**

The current normal practice is to submit drawings prepared in a Computer-Aided Design (CAD) format such as Microstation, AutoCAD, etc. The County does not require the use of a specific CAD format regardless of the program that is used. The primary objective is to present a drawing that is clear, concise, and legible to all parties.

### **2.2.3 Hand Drafting**

In general, hand drafting is discouraged for the submittal of design drawings. Exceptions will be made for small projects such as single family residences or minor plan revisions.

### **2.2.4 Other**

- A. In some cases to save space in a note or standard labeling, an abbreviation is used. An abbreviation is a letter or a combination of letters that, by convention, represents a word or a name in a particular language. A list of standard abbreviations available for plans is provided in Appendix 2-1.
- B. The ground line on the profile shall represent the elevations along the center line of the proposed improvement, such as along the center line of

a storm drain pipe. A solid line represents the proposed grade and the existing ground is shown using a broken (dashed) line.

- C. All unnecessary work, such as duplication of views and notes, redundant details or ornateness in borders, lettering, north arrows, and other features should be avoided. Simplicity shall be practiced in every detail in preparing the drawings and notes should be limited to those required for accurate interpretation.

### 2.3 Cover Sheet

The information to be shown on a cover sheet shall be presented in a thoughtful and logical manner, using a grid system to place items such as notes, certifications, and legends so the drawing looks organized and not cluttered. At a minimum, this information could include general notes, approval blocks (provided by the County on the plan), legend, index of drawings, bar scale, and other pertinent project information. If the information does not fit on one sheet, the information shall be provided on the second sheet of the drawing set.

### 2.4 Scales and Bar Scale

The scale of all drawings and detail sections shall be noted on each sheet. Sketches or typical sections not drawn to scale should be so noted. It is likely that many drawings will either be reduced in size for use in the field or based on available printers. If the drawing is to be reduced, the numerical scale is not useful unless the reduction ratio is known. In such cases a bar scale is necessary. A graphic bar scale for each scale used on the drawing will be shown and positioned near the drawing title, generally in the lower right corner of the sheet.

### 2.5 Plan Notes

All notes should refer only to matter properly related to the drawing: design, construction, and kinds of material. Where necessary to make a drawing clear, notes concerning sequence of construction may be included. In the case of two or more drawings containing a given feature, the notes on the drawings should be carefully compared to avoid inconsistencies.

- A. All lettering in the same contract shall be of the same style, well-formed, and dense black throughout the entire drawing. The minimum height of letters shall be:
  - 1. Notes - **0.1 inch** (10-point font) and legibly spaced
  - 2. Title - 0.20 inch (20-point font)
- B. No lettering shall be smaller than 0.1 inch. Spacing between lines should be at least 1/2 the height of a character's size. Exceptions are allowable for structure schedules and other schedules, provided they are legible.

- C. Notes should not be placed in hatched or shaded areas if it can be avoided. Crowding of notes into a small space should be avoided. Leader lines shall be used to clarify the item referenced. Notes should appear close to the items to which they refer and they should not be grouped in one area of the sheet.

### 2.5.1 Label Notes

For short descriptions of proposed items such as pipe size, spot elevations, house elevations, etc.:

- A. Use all **CAPITAL letters**.
- B. Always use one font type.
- C. The text size shall be a minimum of **0.1 inch**.
- D. Do not use the word “proposed” for any description unless required by another agency. It is assumed all proposed work specified on a plan to be approved will be black, not screened or grayed. Therefore, redundant labeling is not required.
- E. Always include normal word spacing. For example, 15"RCP is not correct because no space exists between the inch symbol and the letter “R.” Instead, it should be shown as 15" RCP.

### 2.5.2 Descriptive Notes

For items needing a slightly longer description such as “connect to existing curb and gutter in line and grade,” a riprap label note, other brief description, or guidance to the contractor:

- A. Use all **CAPITAL letters**.
- B. The text should be a minimum of **0.1 inch high**.
- C. Multiple text heights for different notes are not recommended.

If it is necessary to emphasize a note, it is recommended to present text in a heavier line weight, underline, or provide a box around the note as opposed to using a larger text size.

### 2.5.3 General/Specification Notes

For longer descriptions of procedures, specifications, or alerts, which are generally placed on either a cover sheet or a detail sheet, but may also be placed on plan sheets (see Appendix 2-2 for an example), adhere to the following:

- A. The title should be approximately 0.2 inches high or a 20-point font. The notes should be left-justified, not full justified.

- B. Use 10-point font for a text height. This will create a text height approximately **0.1 inch** high.
- C. Use all **CAPITAL** letters.
- D. All numbered notes will have a space to differentiate between the end of one numbered note and the start of another numbered note.
- E. The note column widths should be established so they are not too wide. Reading widths should be similar to text books or similar types of publications (e.g., reading widths are between 4.5 and 7 inches wide); therefore the recommended column width should be no wider than 6.5 inches.
- F. If necessary, multiple columns may be used to keep narrower notes from being too long on a sheet.

#### 2.5.4 Certifications

The specific language for certifications may be found in Appendix 2-3. The format shall be followed as described below.

- A. Use all **CAPITAL** letters.
- B. The text shall be at least **0.1 inch** high.
- C. The width of the certification should be less than 5.25 inches, if possible.
- D. If there is an approval block that accompanies the certification, the certification text shall be set to the width of the approval block.

#### 2.5.5 Miscellaneous Lettering

Several general guidelines and common sense should be followed in dealing with text and labeling. The first and most important is the alignment of the text with respect to the setup of the drawing. It is preferable the text be oriented parallel with the bottom of the sheet.

Next, commas shall be used in numbers containing four or more digits, except decimal fractions or serial numbers. If only decimal numbers are used, they should have a "0" in front of the decimal point.

### 2.6 Legends

Legends shall be shown on the design drawings. The purpose of the legend is to show existing or proposed features at the same size as shown on the plan to eliminate the need to always label the feature. If a feature is in the legend, it does not need a label on the plan. Legends shall only need to be placed on one sheet for each type of design plan. Generally, legends shall appear on



the cover sheet or the first page of a different design plan. Therefore, different drawings such as “Signing and Pavement Marking Plan” or “Street Tree and Lighting Plan” will have their own legends located on their respective first sheet. See Appendix 2-4 for a sample legend.

Requirements for creating a legend are as follows:

- A. Use all **CAPITAL** letters.
- B. The legend shall consist of a column with a description and one or two columns for the line style or pattern.
- C. Each column should be 2 inches wide and have 0.30-inch spacing. The title of the legend should be left justified and shall be no greater than 0.20 inches high.
- D. The text describing the item in each legend shall be at least **0.1 inch** high.
- E. The text description should be on the left side, with the line style or pattern on the right.
- F. The line style or pattern shall match the size on the design plan.

## 2.7 Plan Dimensioning and Leaders

The purpose of dimensioning is to clearly define the design intent. Plan dimensions for size, form, and location of features shall be complete to the extent that there is full understanding of the design intent. Neither scaling (measuring the size of a feature directly from a design drawing) nor assumption of a distance or size is permitted. No more dimensions than those necessary for complete definition shall be given, and the use of dimensions on a drawing should be minimized.

A plan dimension usually requires the creation of an extension line. Normally, extension lines start with a short visible gap from the outline of the item and extend beyond the outermost related dimension line. Extension lines are used to indicate the extension of a surface or point to a location outside, as represented in Figure 2-1.

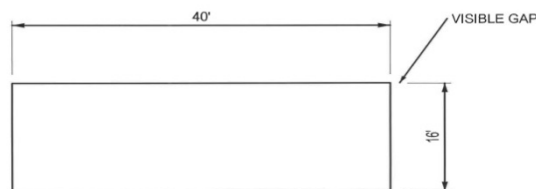

**Figure 2-1 Extension Line Gap**

Whenever practical, extension lines should neither cross one another nor cross dimension lines. To minimize such crossings, the shortest dimensions line is shown nearest the outline of the object, as shown in Figure 2-2. The labels are then staggered to accommodate additional dimensions.

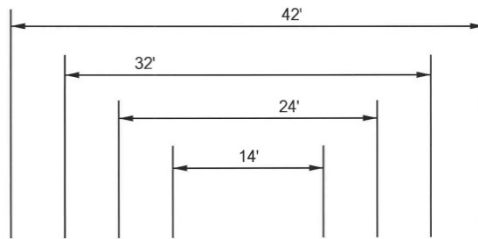

**Figure 2-2 Staggered Dimensions**

Where extension lines must cross other extension lines, dimension lines, or lines depicting features, they are not broken. If extension lines cross arrowheads or dimension lines close to arrowheads, a break in the extension line is advisable, as shown in Figure 2-3.

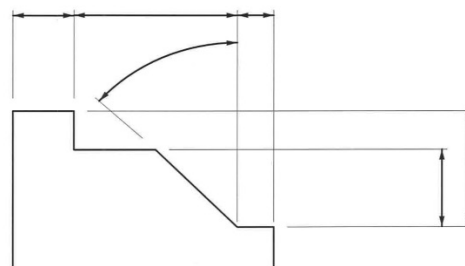

DO NOT BREAK EXTENSION LINES THAT CROSS OTHER EXTENSION LINES, DIMENSION LINES, OR OBJECT LINES

**Figure 2-3 Breaks in Extension Lines for Other Extension Lines**

Grouping of dimensions is a necessary procedure to reduce the number of dimensions to show or later revise. By the use of an overall dimension label and intermediate dimension labels, the last dimension label is not required, as shown in Figure 2-4.

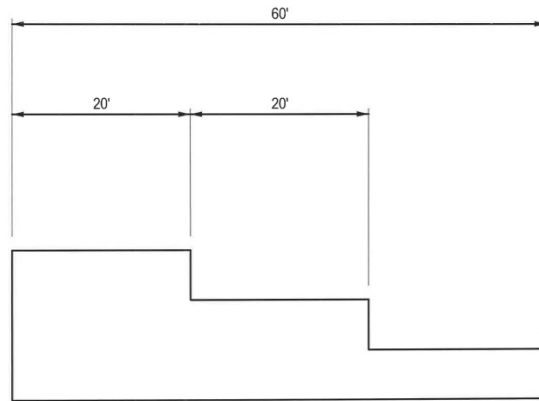

**Figure 2-4 Grouping of Dimensions**

When dimension lines run vertically, place the numbers above the dimension line as viewed from the right. However, not all dimension lines are horizontal or vertical. Figure 2-5 suggests a possible location for such values.

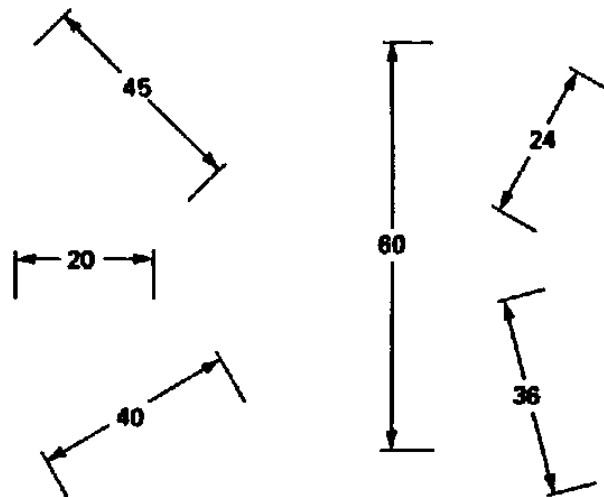

**Figure 2-5 Reading Direction**

## 2.8 Sections

Sections shown on drawings clarify and show hidden and inside objects or features. Sections are indicated by symbols representing a cutting apart by an imaginary cutting plane in a drawing, with an appearance of showing a cut surface.

- A. Dimensions relative to structural components are indicated in feet and inches (6'-4").
- B. First floor elevations, storm drain invert elevations, structure elevations, and finished grade elevations may be shown to two significant figures (0.01').
- C. Generally, earthwork grades and utility elevations are shown to one significant figure (0.1') .

Structural Dimensioning - Dimensions in feet are normally expressed by a small mark to the upper right of a number ('), and inches by two small marks (") in the same location. To separate feet from inches, a dash is used. See example below. The dash in this type of dimension becomes very important, because it avoids dimensions being misread and adds to clarity.

Feet - Inches

25' - 7" Separate feet from inches

Alignment and Profile Stationing - Plan layout and profile stationing should generally be in the same direction. Roads and highways should follow the stationing of the roads to which they connect. In all cases, the abbreviation for the word "station" should be eliminated. At the left end of a profile, the word "STATIONS" should be used once.

Profiles are prepared to represent the vertical relationship of underground utilities or structures. It is important to show all crossings to scale to ensure there are no vertical conflicts that would prevent a utility from being installed. All existing and known proposed crossings must be shown on the profile.

Cross sections should be plotted as viewed when looking in the direction of increasing stationing of the survey (i.e., from Station 0+00 toward the next advancing station). The complete profile station where each cross section was taken should appear under the plotted section. At least two elevations shall be shown along the left margin of the section to relate the elevations to the cross section, as plotted. The survey centerline, or baselines used in the field for construction stakeout control, shall be shown on the cross section.

For large sections, it is helpful to establish horizontal stations for the section, usually stationed 0+00 at centerline and increasing both to the right and left of the centerline. When practical, the cross section should be plotted to the same horizontal and vertical scale, 1" = 5', or 1" = 10', thereby presenting an undistorted view. When this is not possible, these scales should be altered so that the full section can be shown on the sheet. In such cases, for example, the vertical scale may remain 1" = 5' or 10', and the horizontal scale increased from 1" = 20 to 50'. All cross sections shall include the horizontal and vertical scale on the sheet.

## 2.9 Channel Profiles

Channel profiles are drawn so the stations increase from low to high. Channel cross sections are drawn as though viewed in the direction of increasing stations.

## 2.10 Details

Details are commonly shown to “explode” or enlarge areas or features shown in small scale on plans and elevations. Specific features or portions of large structures or objects may be referred to as indicated elevations. Elevation dimensioning is expressed in decimal form to the hundredth of a foot.

## 2.11 Reports

A report summarizing the goals, requirements, and how they were achieved is an integral part of the project. This is an opportunity for the applicant to discuss the project and how the required goals will be met. In discussing how the applicant will meet the established goals, it is important to prepare a report that makes it easy to review the intent. The final report should include the following basic chapter headings, as applicable.

- A. Introduction
- B. Project Description and Narrative
- C. Hydrology and Hydraulic Methodologies
- D. ESD Device Description
- E. Summary Table of ESD Implementation
- F. Structural SWM Measures Utilized
- G. Summary Table of SWM Implementation
- H. Dam Breach Analysis, if applicable
- I. Geotechnical Analysis
- J. Sediment Control Narrative, if applicable

It is the design consultant’s responsibility to provide a report that is easy to follow, concise, and summarizes the required design criteria in a manner that is easily accessible. In addition to each of these sections, the report should include an index, copies of previous approvals, vicinity map, drainage area map, and appendices containing computations. The appendices should be broken into several parts and all pages shall be numbered accordingly.

### 2.11.1 Summary Tables

In addition to text describing the project, goals, and achievements, one or more tables describing required versus provided storage volumes, design elevations,

study points, drainage areas, and other measurements shall be provided. The intent of the summary tables is to contain all the information from the appendices in an easy-to-read format within the report discussion.

### **2.11.2 Graphs, Charts, and Tables**

Graphs, charts, and tables are likely to be reduced for inclusion in reports or computation packages. The top or left of the drawing will become the binding edge.

Therefore, provide at least 1 inch on the top or left side of the graph, chart, or table. Text for these items shall be legible when opening a document from the lower right side of a page. This will ensure the top of the text is oriented to the left or top of a page.

### **2.11.3 Appendices**

The report shall include appendices with computations for each of the items detailed in the report. For example, each SWM facility, ESD device, Sediment Control calculation, and Dam Breach analysis shall be placed in its own appendix. This will help the reviewer find specific areas under review. Each page in the appendix shall be numbered with the appendix letter and the page number.

This Page Intentionally Left Blank

---

## Chapter 3 PERMIT PROCESSING

### 3.1 Stages of Plan and Permit Review

There are three basic stages of plan review for storm drain, SWM, and drainage projects in the County.

Phase One: Land Development Concept Stage Approvals

Phase Two: Land Development Entitlement Approvals

Phase Three: Land Development Final Approvals and Permits

Phase One includes a Site Development Concept Plan, reviewed and approved by the County DPIE Site/Road Plan Review Division. The Site Development Concept Plan (SDCP) is used to obtain many entitlement approvals, construction permits, and building permits. Companion approvals for this stage could include Concept Grading, Erosion and Sediment Control Plans processed by Prince George's Soil Conservation District (PGSCD); Natural Resource Inventory and Type 1 Tree Conservation Plans (processed through the M-NCPPC) Environmental Planning Section; 100-Year Floodplain Studies (processed through DPIE Site/Road Plan Review Division) and Preliminary Plans of Subdivision, Comprehensive Design Plans, and/or Conceptual Site Plans; and Traffic Impact Studies (processed through M-NCPPC Development Review Division). The interdependency of these approvals is displayed in the flowchart in Appendix 3-1.

The interdependency of these plans and the process of approval are dictated by the Zoning Ordinance (Subtitle 27), the Subdivision Regulations (Subtitle 24), and the Trees and Vegetation Regulations (Subtitle 25). The SDCP approval shall be consistent with any plan approved by the Planning Board/District Council.

Phase Two includes a Site Development Plan and Street Grade Establishment Plan (for public streets), which is reviewed and approved by the DPIE Site/Road Plan Review Division. The DPIE Site Development Plan process is triggered for projects that involve an entitlement site plan. Applicants should consult with *PGSCD Soil Erosion and Sediment Control – Pond Safety Reference Manual (PGSCD Reference Manual)* to determine when the Environmental Site Development Grading, Erosion and Sediment Control Plan process is triggered for projects reviewed by PGSCD. Companion approvals in this stage could include entitlement site plans (processed through M-NCPPC Development Review Division). An entitlement site plan could be any of the following:

- Detailed Site Plan
- Specific Design Plan
- Special Permit
- CBCA



- Special Exception Plan

Lastly, Phase Two includes Type 2 Tree Conservation Plans that are processed through the M-NCPPC Environmental Planning Section. The interdependency of these approvals is displayed graphically in the flowchart in Appendix 3-2. The interdependency of these plans and the approval process are dictated by the Zoning Ordinance (Subtitle 27), the Subdivision Regulations (Subtitle 24), and the Trees and Vegetation Regulations (Subtitle 25). The Site Development Plan approval shall be consistent with any entitlement plan approved by the Planning Board and/or the District Council.

Phase Three includes Final Storm Drain, Paving, Grading, SWM Plans and Permits, reviewed and approved by the DPIE Site/Road Plan Review Division. During this stage, the applicant must file a permit to initiate the review and approval process. This permit is filed through the DPIE Site/Road Permit Processing Unit, and shall utilize one or a combination of the three permit types listed below. The permit package must include other plans as well (roadway related).

- Site Development Rough Grading Permit
- Site Development Fine Grading Permit
- Street Construction Permit

In some zones, a Site Development Rough Grading Permit may be secured to allow for early groundbreaking and site work. Applicants should consult with M-NCPPC to determine which zones allow a Site Development Rough Grading Permit prior to or concurrently with entitlement site plan approval. This is governed by the order of approvals identified in County Code Sec. 27-270, 27-544(c), 27-252(g) and (i), or by condition of approval. Site Development Rough Grading Permits allow for rough grading and installation of storm drain and SWM basins, as well as other site utilities such as water and sewer. This type of permit does not allow for building permit issuance or construction.

Site Development Fine Grading Permits allow for fine grading, SWM basins, storm drains, all other forms of SWM (e.g., ESD devices), roadways, paving, driveways, sidewalk, curb/gutter, any utilities, and other site features. This type of permit is required to issue building permits.

The Street Construction Permit is for construction within the public right-of-way, plus any area outside of the public Right-of Way necessary for road construction. It does not allow for site grading or offsite ESD construction. The work could include any or all of the following: street grading, storm drain, ESD, SWM, paving, street trees, street lights, maintenance of traffic (MOT), and signing and marking plans. All permit fees, bonds, and easements will be incorporated into the final permit issuance. If site work is required, a Site Development Fine Grading Permit is also required.

The interdependency of these approvals is displayed graphically in the flowchart in Appendix 3-3.

### 3.1.1 Plan and Permit Applications and Fees

For all drainage, storm drain, and SWM activities, an application must be completed and submitted to the DPIE Permits Processing Unit on the first floor of 9400 Peppercorn Place, Largo, Maryland. Current application forms are available on the DPIE website given below. In general, the following information provides guidance for application and fee-related issues.

- A. Application: The appropriate application should be completed and included with first plan or permit submission. The applications may be found on the County website at this link.

#### [DPIE Plan/Permit Applications](#)

Types of plan and permit applications to choose from include:

- Site Development Concept Plan Application
  - Floodplain Plan Review Submission Form
  - Site Development Plan Application
  - Site/Road Permit Processing Unit Application for Construction and Related Activities within the Public Right-of-Way and Private Property Site Work (this is the universal application form utilized for most site and road permits).
  - Site/Road Permit Processing Unit Application for Residential Driveway Construction and Related Activities within the Public Right-of-Way and Private Site Work. This application form is utilized for individual residential driveways and driveway culverts.
  - Special Drain Permit Application
- B. Owner/Applicant Name/Address: The name and address of the owner/applicant on the application must be the same as on the plan to be reviewed.
- C. Application Signature: The application must be completed and signed by the owner or an authorized agent. Either of the following may be used for an authorized agent.

1. The application may be signed by the design consultant, with “AGENT” added after the signature.
  2. A separate form submitted with the permit application (signed by the applicant) designating that a third party may sign applications.
- D. Submittal Checklist: The submittal checklist for the plan or permit type must be prepared by the design consultant or applicant and included with the plan or permit submittal package.
- E. Design Review Checklist: For each type of plan or permit, the applicant shall use the corresponding design review checklist. The checklist(s) must be completed by the design consultant and included with the plan or permit submittal package. The design consultant shall include multiple design review checklists, as appropriate for the work proposed in the permit. They may be found at this County link:
- [DPIE Review Checklists](#)
- F. Waiver of Review Fees: Prince George’s County affiliated public services (e.g., public health services, mental health services, schools, hospitals, libraries, fire departments, detention centers, Prince George’s County DPW&T, M-NCPPC, WSSC, and Office of Central Services) will not be charged any review fees per County Code Sec. 32-115 and 32-120.
- G. Municipal Participation: Municipal projects that are being jointly designed and/or constructed by DPIE or DPW&T are exempt from review fees.
- H. Federal and State Project Fees: Federal and State projects that require review by the County will be required to pay full fees. Generally, Federal projects are required to be reviewed through the County’s Mandatory Referral process.
- I. Nonprofit Fees: Nonprofit organizations, churches, chartered cities, and municipalities will be required to pay 1/2 of the fee schedule amount per County Code Sec. 32-120 a.
- J. Collection Procedures/Timing: The timing for collection of plan review and permit fees varies depending on the type of plan or permit.
- SDCP review fees are collected at first submittal.
  - Floodplain Modeling and Review fees are collected at first submittal.
  - Storm drain and paving permit filing fees are partially collected at permit filing. Permit fees are equal to 10% of the cost of construction in the public right-of-way, plus grading fees and public/private storm drain review fees. At the time of permit filing, the grading permit fees, storm

drain review fees, and 1/3 of the 10% fee are collected. The balance of the permit fee is collected prior to permit issuance.

- Storm Drain “per foot” review fees are due at the time of permit issuance.
- Special drain permit fees are collected at the time of permit filing
- A storm water fee-in-lieu is collected before a permit is issued for a public storm drain system and before approval for private storm drain systems.
- A Pond Maintenance Fee is collected prior to permit issuance.
- A reforestation fee-in-lieu is collected prior to permit issuance.
- Extension fees for plan and permit extension are collected at the time of permit expiration/renewal.
- Copy services are paid at the time services are rendered.

K. Refund Procedures: For overpayment of fees due to deletion and/or changes of plans, submit a request to DPIE for processing. DPIE will complete County Form 114 for forwarding to the Office of Finance.

### 3.1.2 Phase One - Land Development Concept Stage Approvals

#### A. Site Development Concept Plan

Purpose: An SDCP approval is the basic building block for many other County plan approvals, is an element in the first part of the development process, and is required to obtain a building permit. This approval is required for issuance of permits to allow land disturbance activities in the County. If only work **inside** the building is proposed with no land disturbance, then an SDCP is not required. The SDCP identifies the required SWM measures, including how ESD to the MEP has been met; how required road widening along the front of the property and offsite road improvements are met, sight distance evaluation, floodplain impacts, and setbacks. Other site-related guidance that the County determines is appropriate may be required under County Code, Subtitles 23, 24, 27, and 32. Coordination with M-NCPPC prior to or concurrent with the approval of the SDCP is important to ensure that no conflict occurs with zoning and subdivision limitations on the development envelope, open space requirements, recreational areas, or the other site requirements of the entitlement plan approved by the Planning Board and/or the District Council. Conflicts in the plans could be viewed as a preemption of the Planning Board/District Council’s authority, which is not allowed.

Inter-Dependency with Other Approvals: The SDCP is a requirement under County Code Sec. 32-177. In addition to DPIE, other agencies (such as PGSCD, and M-NCPPC)

require this approval for plan and permit processing, as it provides guidance for the various plan review and approvals by these agencies. Generally, this plan should be submitted after the Natural Resources Inventory (NRI) has been submitted to M-NCPPC Environmental Planning Section. The NRI must be approved prior to approval of the SDCP.

The SDCP requires a public notification, as defined in County Code Sec. 32-182 (g). This public notification involves mailing letters to all adjacent/abutting property owners, certain public officials, and parties of record within a certain radius of the project. The list of public officials and parties of record must be confirmed through coordination with M-NCPPC Planning Information Services located on the lower level of the County Administration Building. The public notification must be mailed within 7 days of submittal of the SDCP. Resubmission of the SDCP package must include an Affidavit to confirm that this public notification mailing has occurred. This public notification process and sample notifications are documented in Appendices 5-5 and 5-6.

The SDCP submittal, and often approval, is required before a Preliminary Plan of Subdivision can advance to the Planning Board for approval. An SDCP approval is required **prior** to acceptance for a Conceptual Site Plan; prior to approval of a Detailed Site Plan if no preliminary Plan of Subdivision is required; prior to approval of any plan approved by PGSCD, or any grading or building permit issued by the County unless the permit is waived per County Code Sec. 32-174. The SDCP approval letter must also be submitted to DPIE for subsequent permit reviews, including building and site/road permits.

Submittal Requirements: The County requires the completion of an application, submittal checklist, and design review checklist, as well as the SDCP and computations. Information provided on the application or checklists is necessary for processing by the County, as it defines information about the site and the surrounding area. The checklists also provide guidance to the design consultant to ensure that sufficient information is submitted, so the County can review the package in an efficient manner.

Other Jurisdictional Requirements: The SDCP is required in all parts of the County except the City of Bowie and State or Federal lands. For proposed projects located within the City of Bowie’s municipal boundary, the City’s version of an SDCP will be processed. Contact the City for additional information. For State and Federal projects, an equivalent plan must be submitted to the MDE for approval.

Fees: Review fees for an SDCP per County Code Sec. 32-120 are:

- a. Single residential lot - \$100
- b. All others - \$250

Validity Period: The SDCP approval is generally valid for a maximum of 3 years. The plan approval may be extended for an additional period of up to 3 years for each

renewal with a request sent to DPIE along with a renewal fee of \$100. The number of extensions that may be requested is unlimited.

#### **B. Fee-in-Lieu of On-Site Stormwater Management**

During the SDCP review process, a project may be assessed a fee-in-lieu for onsite 10-year ( $Q_P$ ) or 100-year ( $Q_F$ ) SWM, if some on-site management requirements are waived or reduced. In some cases, land conveyance, SWM facility construction, or offsite improvements may be required in addition to, or in place of, a monetary contribution, as determined appropriate by DPIE. The “fee-in-lieu” will be utilized to fund the purchase of land, design, and/or construct and modify SWM facilities and improvements throughout the County.

The SWM fee is currently assessed in accordance with Schedule 3-1. This schedule was established under County Code Sec. 32-120 and is subject to periodic revisions. Fees for any other zone not included in this schedule will be based on the proposed land use at a rate of \$16,000 per impervious acre. For residential uses, the fee will be proportioned on a dwelling unit basis at \$750 (maximum) per dwelling unit.

#### **C. Credits for Fee-in-Lieu**

From County Code Sec. 32-120 (9) (C) - *A one third reduction in the assessed fee will be made for each of the following on-site storm water measures that the applicant is required to provide:*

1. *Water quality management or ESD. (1/3 reduction)*
2. *1-year extended detention or ESD. (1/3 reduction)*
3. *Flood control facilities (10-year or 100-year storm water management). (1/3 reduction)*

Schedule 3-1 Stormwater Management Fee-in-Lieu

Zone	Typical % Impervious	Residential Fee Per Dwelling Unit	Non Residential Fee Per Acre
O-S	1.0	\$160	
R-A	1.5	\$240	
R-E	12	\$750	\$1,920
R-R	18	\$750	\$2,880
R-80	22	\$750	\$3,520
R-55	26	\$750	\$4,160
R-35	40	\$750	\$6,400
R-T	50	\$750	\$8,000
R-20	50	\$750	\$8,000
R-30	50	\$750	\$8,000
R-18	55	\$750	\$8,800
R-H	75	\$250	\$12,000
R-10	75	\$250	\$12,000
I-1	80		\$12,800
I-2	80		\$12,800
I-3	75		\$12,000
I-4	70		\$11,200
C (All)	90		\$14,400

**D. Reductions in Fee-In-Lieu Rate**

From County Code Sec. 32-120 (9) (C) (ii)

(ii) *The Director may adjust the fee:*

(aa) *To an amount based on the actual impervious area if the site plan approved by the Planning Board and/or District Council provides that the impervious area of*

*the development will be less than the maximum allowed under the County's zoning regulation and the applicant demonstrates that future increases in the impervious area are unlikely. For residential zones, the fee reduction will be proportioned on a dwelling unit basis at a maximum of Seven Hundred Fifty Dollars (\$750.00) per dwelling unit. The fee reduction will be calculated using the formula of Actual Impervious Acreage x \$16,000.00;*

- (bb) *To reflect the cost of land which the applicant agrees to provide for a regional storm water facility;*
- (cc) *To exclude undeveloped area (i.e., floodplains) or areas requiring a subsequent storm water management concept plan from the fee computation for industrial and commercial developments; or*
- (dd) *To the actual cost of providing on-site controls to the extent that the applicant can demonstrate such actual costs to the satisfaction of the Director.*

See Section 5.2.5.1 for fee reductions where off-site mitigation is the selected option.

#### **E. Floodplain**

A 100-year floodplain delineation approval is required for projects where stream(s) or channel(s) have a drainage area of 50 acres or greater.

Timing and Dependency on Other Approvals (Existing Channel Conditions): The approval of the 100-year existing conditions floodplain delineation must occur prior to Preliminary Plan of Subdivision approval, if applicable, or prior to any permit issuance. An existing conditions floodplain study shall be submitted by the design consultant to DPIE at project onset. The existing conditions 100-year Floodplain Study is generally submitted prior to, or concurrent with, the NRI submittal. See the Environmental Technical Manual for additional information on floodplain approval requirements. Approval of an existing conditions 100-year Floodplain Study does not depend on approval of the SDCP.

Timing and Dependency of Other Approvals (Proposed Conditions): If stream crossings, floodplain fill, or alterations within the floodplain are proposed for the project, the SDCP process will evaluate and indicate whether the floodplain modification is acceptable. If deemed acceptable, this modification will require processing and approval of a proposed conditions floodplain approval, per Subtitle 32, Division 4, and mitigation for fill in the floodplain. The floodplain modification or fill will be reviewed at the permit stage. Detailed information about the preparation of an existing or proposed floodplain study may be found in Chapter 4.

Purpose: The purpose of establishing the limits of the existing 100-year floodplain is to ensure that new structures are not sited within the 100-year floodplain, the development activity provides floodplain buffers, proposed stream crossings (culverts and bridges) are sized appropriately, and other appropriate conditions apply. The approved floodplain delineation is typically enclosed in an easement that is depicted on the record



plat. The easement delineation will be verified by DPIE as part of the M-NCPPC process for reviewing final plats. An easement document is required by the County as part of the Final Plan approval process that ties the grant of the easement on the record plat to the document recorded in land records. This grants the easement to the County and sets forth the rights, restrictions, and liabilities of the parties.

Fees: The fee schedule from County Code Sec. 32-120 for conducting a floodplain study using the County's Geographic Information System (GIS)-based floodplain models and for providing floodplain information to the public is assessed in accordance with the following:

1. Studies for existing channel conditions only - \$2,500
2. Studies for both existing and proposed channel conditions - \$3,500
3. Studies for a single lot - \$250
4. Fee for a Floodplain Inquiry - \$50
5. Review of floodplain study or delineation prepared by Design Consultant - \$0.50 per linear foot of stream within the property, plus \$200 per structure. This also applies to studies with topography or a datum change.
6. Establishing a floodplain elevation with no study - \$50

The floodplain approval does not expire. No fees are necessary to update the floodplain for a site where the floodplain was approved. However, if a revised existing conditions floodplain delineation is requested using approved floodplain elevations, the review fee shall be \$0.50 per foot of floodplain.

### 3.1.3 Phase Two - Land Development Entitlement Approvals

- A. **Site Development Plan:** A Site Development Plan is Phase Two of the MDE's three-phase comprehensive plan approval process. Submission requirements are codified in County Code Sec. 32-182. The plan approval does not result in a permit issuance; rather, it is precursor to the Approval/Permit stage (Site Development Rough Grading, Street Construction, or Site Development Fine Grading permits).

The Site Development Plan establishes the locations and sizes of impervious areas, outfalls, SWM facilities, and ESD devices. It is used by PGSCD to ensure sediment devices are not placed in locations that could affect the future functioning of ESD devices. See Appendix 3-2 for a flowchart of the review and approval process.

Submittal Requirements: An application, submittal checklist, and design review checklist are available on the DPIE website. Additional information for plan requirements and submittal information may be found in Chapter 6 of this document.

Timing: This plan is generally filed after the SDCP approval by DPIE, the Concept Grading, Erosion and Sediment Control Plan approval by PGSCD, and the Preliminary Plan of Subdivision approval by the Planning Board. This plan shall be submitted as part of the entitlement site plan (detailed site plan or specific design site plan), through the M-NCPPC application process.

Combination with Other Processes: If the site is not subject to an entitlement site plan (Detailed Site Plan, Specific Design Site Plan, etc.), the review of the Site Development Plan can be combined with the Final Plan review process.

- B. **Street Grade Establishment Plan** The requirement for a street grade establishment plan is further defined in the DPW&T *Standards and Specifications for Roadways and Bridges*. This plan is typically submitted and processed during Phase Two of the project for any project with public roads. There is no fee required for review.

### 3.1.4 Phase Three - Land Development Final Approvals and Permits

Land development projects generally involve issuance of Site Development Rough Grading permits, Site Development Fine Grading permits, and/or Street Construction permits to facilitate site/road construction. The design plans required for permit may be submitted after DPIE issuance of the Phase Two conditional approval letter. See Appendix 3-3 for a flowchart of the three types of permits described below. See Appendix 3-4 for sample permit stamps placed on drawings and permits issued.

#### A. Site Development Rough Grading Permit

Scope of Work: A Site Development Rough Grading Permit allows for construction of storm drain and storm water management facilities, in addition to rough grading. This process is intended to allow for earlier construction of the following:

- Water
- Sewer
- Storm Drain
- SWM infrastructure
- Grading
- Retaining Walls

A separate WSSC approval and permit is required for water and sewer construction. A retaining wall does require a separate building permit. This permit does not support building construction, street construction or ESD, or larger scale Best Management Practices (BMPs) – e.g., rain gardens, bio-retention,

micro-bio retention, submerged gravel wetlands, bios wales, or infiltration trenches – because these are prone to clogging if built too early in the construction sequence and because the placement of these smaller devices is largely dictated by the final design of all site elements.

Plan Approvals: Site Development Rough Grading permits typically require the following approvals:

- Small Pond Approval or Waiver of Small Pond Approval by PGSCD prior to permit issuance, if applicable
- Final SWM and Storm Drain Plan approval from DPIE
- Rough grading erosion/sediment control plans (PGSCD)
- SDCP approval (DPIE)
- Site Development Plan approval (DPIE), if applicable
- Concept Grading, Erosion Grading, and Sediment Control Plan
- Environmental Site Development Grading, Erosion and Sediment Control Plan, if applicable
- Type 2 Tree Conservation Plan (TCP2) approval or Woodland Conservation Ordinance (WCO) Exemption Letter (M-NCPPC)
- Floodplain approval, if applicable
- Entitlement Site Plan approval by M-NCPPC, if required by zoning code or other conditions of approval
- Record plats, if required by zoning code

Submittal Requirements: For more information, see Chapter 7 of this document for the preparation of the permit application and Chapters 8 to 11 for design information. Specific submittal information is contained in the application, submittal checklist, and design review checklists.

If an item is not applicable, please indicate this on the checklist. If the Site Development Rough Grading permit is not issued within 6 months of the application, the applicant shall submit a letter to the Permits office requesting an extension of the application.

This permit validity depends on the scope and type of work.

Grading Only, not in public right-of-way- - Up to 5 years with a one-time, not to exceed 1-year extension for a maximum of 6 years. See County Code Sec. 32-143 for additional guidance.

Storm Drain, SWM, and public right-of-way grading - Two years if performance bond amount is less than \$500,000, and 3 years if performance bond amount is greater than \$500,000. The permit may be extended for a maximum validity period of 6 years. See County Code Sec. 23-122 for additional information on permit extensions.

#### B. Site Development Fine Grading Permit

Scope of Work: An Site Development Fine Grading Permit allows for construction of public and private site work including public and private storm drain, SWM facilities, ESD and larger scale BMPs (rain gardens, bio-retention, micro-bio retention, submerged gravel wetlands, bios wales, infiltration trenches, etc.), fine grading, public and private streets and paving, and water and sewer facilities. (A separate WSSC approval and permit is required for water and sewer construction.) This type of permit does support building construction, and issuance of this permit is required prior to, or concurrent with, Site/Road permit processing unit approval of a building permit. Retaining wall construction may be included as part of the Site Development Fine Grading permit; the retaining wall construction requires a separate building permit.

Plan Approvals: Site Development Fine Grading permits typically require the following approvals:

- Small Pond Approval or Waiver of Small Pond Approval by PGSCD prior to permit issuance.
- Final SWM, Storm Drain, Paving, and Roadway approval from DPIE.
- Other roadway plans including striping and signage, street tree and lighting, MOT, and other roadway related plans.
- Final Grading, Erosion, and Sediment Control Plan approval (PGSCD)
- SDCP approval (DPIE)
- Site Development Plan approval (DPIE and PGSCD), if applicable
- Concept Grading, Erosion Grading, and Sediment Control Plan

- Environmental Site Development Grading, Erosion and Sediment Control Plan, if applicable
- TCP2 approver or WCO Exemption Let (M-NCPPC)
- Existing and proposed floodplain approval, if applicable
- Entitlement Site Plan approval by M-NCPPC, if required by zoning code or condition of approval
- Record plats, if required by zoning code

Submittal Requirements: For more information, see Chapter 7 of this document for the preparation of the permit application, and Chapters 8 through 11 for plan design criteria. Specific submittal information is contained in the application, submittal checklist, and design review checklists. If an item is not applicable, please indicate this on the checklist. If the SDFG permit is not issued within 6 months of the application, the applicant shall submit a letter to the Permits office requesting an extension of the application.

This permit validity is as follows.

Storm Drain, SWM, Grading, and Roads – Two years if performance bond amount is less than \$500,000, and 3 years if performance bond amount is greater than \$500,000. The permit may be extended for a maximum validity period of 6 years.

#### C. **Street Construction Permit**

This permit is for construction within the public right-of-way, plus any area outside of the public right-of-way necessary for road construction. It does not allow for site grading. The permit work can include any or all of the following in the public road right-of-way – street grading, storm drain, ESD, SWM, paving, street trees, street lights, MOT, signing and marking plans, bridges, and traffic signals. All permit fees, bonds, and easements will be incorporated into the final permit issuance. If site work is outside the public road, a Site Development Fine Grading Permit is also required.

This permit validity period is as follows.

Storm Drain, SWM, and roads – Two years if performance bond amount is less than \$500,000, and 3 years if performance bond amount is greater than \$500,000. The number of extensions is unlimited.

D. Major Permit Plan Review and Permit Fees

The County Plan review and permit fees are governed by County Code Sec. 32-120. Plan review and permit fees include plan review, permit review and approval, construction inspection, bond processing, easement review and recordation, and permit release. Construction cost estimates should be submitted with the initial permit package. Unit costs should be based on the County’s approved unit costs included in the latest version of the County’s *Specifications and Standards for Roadways and Bridges*. Please refer to the submittal checklists and Fee and Bond worksheet included in Appendix 12-2 for clarity on all fees associated with a particular permit type. The fees for SDFG, Site Development Rough Grading, and Street Construction Permits are calculated as listed below:

1. Review fees for Public Storm Drain system - \$3.00 per linear foot (lf) of public storm drain pipe with a \$250 minimum charge.
2. Review fees for Private Storm Drain system - \$1.50 per linear foot of private storm drain pipe with a \$125 minimum charge.
3. Permit fees for Public Storm Drain, SWM, and Roadway Construction are based on 10% of the construction cost estimate for these facilities in the public right-of- way. One-third of the 10% fee is paid at the time of filing and the remainder prior to permit issuance. (Note: This construction cost estimate and permit fee must also include all elements within the public right-of- way, including storm drain, SWM, grading, paving, curb and gutter, sidewalk, street trees, traffic signal, striping, MOT, and all other work within the public right-of- way).
4. Grading review fees based on the disturbed area within the permit limit outside of the public right-of- way are taken from the fee schedule in County Code Sec. 32-120 and calculated as follows:

Minimum \$20

0 to less than 1 acre:	\$0.006/square foot (sf)
1 to less than 2 acres:	additional \$230/acre
2 to less than 10 acres:	additional \$160/acre
10 to less than 50 acres:	additional \$90/acre
50 to less than 200 acres:	additional \$50/acre
200 less than 600 acres:	additional \$24/acre

5. Street Sign Fees: \$228.94 per sign for permits that include public roadways.

6. Special Utility Permit Fee: \$300 plus \$2.00 per linear foot for underground utility under roadway, plus \$0.50 per linear foot of underground utility not under roadway, plus \$0.20/linear foot of aerial utility in right-of- way.
7. M-NCPPC Permit Review Fee: \$5 per review/revisions
8. Stormwater Fee-In-Lieu – as defined on the SDCP approval letter and required by County Code Sec. 32-120 and described in Chapter Sec. 3.2.C.
9. Woodland Conservation Fee-in-Lieu – as calculated by M-NCPPC and based upon County Code Sec. 25-122. The fee is based on \$1.08 per square foot of conservation area to be provided in Non-Priority Funding areas and \$0.90 per square foot of conservation area to be provided in Priority Funding areas.
10. Chesapeake Bay Critical Area Fee – as calculated by M-NCPPC and based upon County Code Sec. 5B-116.
11. Pond Maintenance Fee: Based on \$10,000 per public pond or 10% of construction cost, whichever is greater, as required by County Code Sec. 32-185.
12. Floodplain Review fees as previously defined in Chapter Sec. 3.1.2.E of this manual and County Code Sec. 32-120.
13. Payment in Lieu of Road Construction – per County Code Sec.23-116.
14. Restoration Permit Fees (driveway) – Residential \$75; Commercial \$75.

**E. Intermediate Plan Approvals – Storm Drain/ SWM Only and Conditional Permit**

Storm Drain (SD)/SWM Only Plan Approval: Applicants may apply for a Site Development Rough Grading, Site Development Fine Grading, or Street Construction permit, which can include SD or SWM Plans in the permit package. If requested, DPIE will issue a SD/SWM ONLY plan approval (formerly known as “Technical Approval”) midway through the permit review process. This approval will be issued after all SD and SWM-related comments are addressed, and all related SD and SWM facility easements have been recorded.

The option of issuing this SD/SWM ONLY plan approval prior to permit issuance allows for subsequent processing through PGSCD and WSSC without posting all bonds and fees for permit issuance. This includes plan approval by

DPIE for SD and SWM systems ONLY. Roadway systems (paving, sidewalk, curb and gutter, pavement marking, signage, signals, and other roadway appurtenances), grading, and permitting will require further review.

If a permit for this work is not secured within 6 months of this approval, this approval expires and all previously paid permit fees are forfeited. In this instance, the permittee shall file for permit extension and pay the required filing fees. **This approval does NOT represent a permit to construct.**

Conditional Approval: Similarly, if requested, DPIE will issue a conditional permit midway through the Site Development Rough Grading, SDFG and Street Construction permit process. This permit will be issued after all plan comments have been addressed and all related easements have been recorded in the County Land Records. This conditional permit represents complete plan approval by DPIE for roadway and drainage systems included in the plan (SD, SWM, paving, sidewalk, curb and gutter, pavement marking, signage, signals and other roadway appurtenances, and grading). Additional outstanding permit requirements, including payment of fees and posting of bonds must be satisfied for final permit issuance.

If a permit for this work is not secured within 6 months of this approval, this approval expires and all previously paid permit fees are forfeited. In this instance, the permittee shall file for permit extension and pay the required filing fees. **This approval does NOT represent a permit to construct.**

### 3.2 Plan and Permit Revisions

Minor revisions such as updating plan approval, changing the applicant or permittee's name, and other minor changes (as determined by DPIE) that do not result in a change to the design will require a fee payment of \$100.

Major revisions require a revision fee in the amount of 25% of the original review fee, with a minimum fee of \$100.

### 3.3 Updating of an Approved Plan

Processing an update for a SD or SWM plan approval is required every 24-months. A valid SDCP is required. A fee of \$100 is required to update the approved plan.

### 3.4 Special Drain Permits

Special drain permits will be issued for small construction projects to private property owners when they wish to connect a private storm drainage system to an existing public system that is maintained by the County. This type of permit may also be used when SWM/water quality systems are proposed by State agencies and these systems connect to the existing or proposed public system maintained by the County.



Examples of system connections that would qualify for a special drain permit, include sump pump discharge pipes, underdrains, and minor field connections. The plans may be reviewed on a walk-in basis and require an accompanying sketch depicting the connection point. See Appendix 3 for the Special Drain Permit Application Form and details to be utilized for such purposes.

- A Review Fee of \$100 will be charged for each connection point.

### 3.5 As-Built Plan Approval

After projects have been constructed, as-built plans are required to document the built condition of public SD systems, SWM facilities, and ESD devices. These as-built plans are required, along with many other supporting documents, to obtain a release of permit, per County Code Sec. 32-191. An application must be filed at the DPIE Site/Road Permits Processing Unit to start the process. It is recommended that as-built plans be prepared and processed as soon as possible after the construction of the system or device has been completed. In the case of small pond SWM facilities approved under MD-378 criteria, these facilities require submittal of a “dam safety” as-built plan if utilized as a sediment basin, or a final SWM as-built plan within 30 days of the completed dam construction. For additional information on as-built submittal requirements, see Chapter 15 of this document. The application package shall include the completed as-built plan submittal and as-built plan review checklists. The checklists are available on the DPIE website.

- A review fee of \$250 will be charged for each as-built plan submittal.

### 3.6 Other Agency Permits and Coordination

Other approvals and permits may be required for site work for land development projects. These typically include permits issued by WSSC, utility companies, municipalities including the Cities of Bowie, College Park, and Laurel, etc.; State Agencies including the Maryland State Highway Administration (MSHA), MDE, and the Maryland Department of Natural Resources (DNR); Federal Agencies (U.S. Army Corps of Engineers (USACE), Federal Emergency Management Agency (FEMA), U.S. Fish and Wildlife Service), or other agencies. It is the applicant’s responsibility to recognize the need for obtaining applicable permits from all other agencies. A list of typically required permits is as follows:

- Non-Tidal Wetland Permits (USACE/MDE)
- Waterway Construction Permit (MDE/DNR)
- Tidal Wetland Permits (USACE/MDE)
- General Discharge Permit for Construction Activity (MDE)
- System Extension Permits (WSSC)

- Onsite Water and Sewer Permits (WSSC)
- Plumbing Permits (WSSC)
- Access Permits (MSHA)
- Letter of Map Revision (LOMR) (FEMA)
- Various Permits from Municipalities

A summary table of which approvals and permits are issued by the County versus the municipality in various municipalities in the County is available from this link.

[Municipal Permitting Responsibilities](#)

This Page Intentionally Left Blank

---

## Chapter 4 100-YEAR FLOODPLAIN

### 4.1 Introduction

The County's DPIE administers floodplain regulations in the County, except in the City of Laurel. The County requires floodplain delineation for any stream with a drainage area greater than 50 acres, and in some cases certain streams with an identified floodplain for areas of less than 50 acres, per County Code Sec. 32-209 (a). The County has many streams with floodplain limits identified by FEMA. These studies are based on existing conditions development at the time they were prepared. In addition to floodplains identified by FEMA, the County has other resources used to identify floodplain areas in the County. These include County prepared and approved floodplain studies for most major streams. County prepared studies are based on ultimate development and utilize existing zoning. The County also has an inventory of floodplain studies and danger reach analyses of breached dams prepared by consultants for individual properties. County approved studies may have flood elevations higher than FEMA studies. For those cases, the County study will be used as the determining factor for the limits of a floodplain. See County Code Sec. 32-204 for additional information. **ALL OF THE COUNTY RESOURCE INFORMATION MUST BE RESEARCHED TO ENSURE FLOODPLAIN LAND IS PROPERLY IDENTIFIED AND DELINEATED ON THE PROPERTY. THIS STEP MUST BE FOLLOWED PRIOR TO SUBMISSION OF ANY FLOODPLAIN DELINEATION THAT WILL USE EXISTING STUDIES TO VERIFY THAT THE CORRECT STUDY ELEVATIONS ARE SHOWN.**

Contact DPIE to obtain the appropriate study to use for a property. The process of requesting previously approved 100-year floodplain studies is shown in the flowchart included in Appendix 4-1. If it is determined a floodplain study does not exist, the applicant can choose to request a 100-year floodplain study utilizing GIS modeling to be performed by the County DOE, or the applicant can choose to prepare a floodplain study using a private consulting firm.

This chapter itemizes the established criteria to help clarify policies and procedures relating to floodplain study submittals in the County.

### 4.2 Authority of Jurisdiction

#### 4.2.1 Prince George's County

The following is a summary of the legislative history for establishment and identification of flood prone land within the County.

- A. Council Bill 63-1980, adopted and published in the 1979 Edition of the Prince George's County Code, enacted July 15, 1980, signed by the County Executive July 30, 1980, and effective on the same date, re-enacted the Zoning Ordinance and the Subdivision Regulations providing for restrictions on new developments in 100-year floodplain areas and encouraging reservation of floodplain areas as open space.

- B. Council Bills 37-1983 and 110-1983 were signed by the County Executive and became effective August 3, 1983, and October 31, 1983, respectively. These bills revised the County Building Code, entitled “Construction or Changes in Floodplain Areas” and “Grading, Drainage, and Erosion Control,” to maintain the 100-year flood protection standard and provide for the designation of floodplains in conformance with FEMA requirements, and to restrict development in such areas.
- C. Council Bill 64-1987, adopted June 30, 1987, designated DER as the agency that must approve floodplain limit determinations. Subtitle 4, Division 2, Section 4-187(a)(1) of the Building Code specifically provided for the publication of requirements and criteria for floodplain studies to be submitted to the DER.
- D. Council Resolution CR-17-1978 (adopted 2-28-78) exempted all construction within the corporate limits of the City of Laurel from the provisions of Subtitle 4 of the County Code. Therefore, all floodplain submissions within the corporate limits shall be reviewed by the City of Laurel. The City may, at its option, request the County’s input or assistance in such reviews.
- E. Council Bill 24-1989 (DR-2) was adopted April 4, 1989, for the purpose of revising the County’s Floodplain Ordinance to conform to Federal and State requirements for continued participation in the National Flood Insurance Program, Federal and State financial assistance, disaster relief, and for additional local requirements.
- F. Council Bill 15-2011 (DR-3) was adopted July 2011 for the purpose of moving Subtitle 4 of the County’s Floodplain Ordinance to the new Subtitle 32. It also transferred approval authority from DOE to DPIE.

#### 4.2.2 FEMA Program

In September, 1999 the FEMA and the County signed an Interagency Agreement to allow the County to participate in a new FEMA initiative called the Cooperating Technical Community (CTC) Program. Under this program, FEMA has delegated a portion of its floodplain authority to the County. Specifically, the tasks involved under this CTC Program are as follows:

- A. FEMA provides grant funding to develop a countywide GIS-based 2-foot topography using newly developed technology such as Light Detection and Ranging (LiDAR). The MSHA and the M-NCPPC are the other two partner agencies for this joint effort.

- B. FEMA provides grant funding to update the entire FEMA study (normally referred to as the Flood Insurance Study) using the DOE GIS-based Hydrology and Hydraulics (H&H) models.
- C. With this GIS floodplain mapping and other GIS databases, the County identifies flood prone structures and properties. This information is very important for the flood risk assessment. Therefore, DOE conducts a detailed Damage Assessment Analysis after a flood event.
- D. The County conducts technical review of all FEMA Letter of Map Amendment (LOMA) and LOMR requests and then updates the FEMA maps with these changes. The County will request that the FEMA review fee be provided to the County for inclusion with the submittal package to FEMA.
- E. FEMA has established administrative procedures to change the designation for individual properties on the Flood Insurance Rate Map, or FIRM. These processes are referred to as the LOMA and the Letter of Map Revision Based on Fill (LOMR-F) process. Through these processes, an individual who owns, rents, or leases property may submit certain mapping and survey information to FEMA and request that FEMA issue a document that officially removes a property and/or structure from the Special Flood Hazard Area (SFHA). In most cases, the applicant will need to hire a Professional Land Surveyor or Professional Engineer to prepare an Elevation Certificate for the property. Upon receiving a complete application package, FEMA will normally complete its review and issue a determination in 4 to 6 weeks. Additional information may be obtained from [National Flood Insurance Program](#)
- F. The County may conduct Floodplain Studies for any property without a floodplain study using the GIS-based H&H models. The results of the studies will be incorporated into the LOMA or LOMR process. For information on the process, the following website may be consulted.  
[FEMA LOMR Process](#)
- G. The County will provide floodplain inquiry services to homeowners and insurance companies.

### 4.3 Acceptable Studies

Private consultant engineering studies and studies using the County's GIS-based floodplain models are accepted by DPIE. Table 4-1 denotes the agency responsible for providing data to the public for existing floodplain studies.

**Table 4-1 Agency Responsible for Providing Floodplain Data to the Public**

	<b>Map</b>	<b>HEC-2</b>	<b>Drainage Area MAP</b>	<b>TR-20</b>	<b>TR-55</b>
<b>FEMA Floodplains</b>	DPIE	FEMA	FEMA	FEMA	FEMA
<b>County Prepared Watershed Study</b>	DPIE	DOE	DOE	DOE	DOE
<b>County Prepared for Private Development</b>	DPIE	DOE	DOE	DOE	DOE
<b>Private Consultant Prepared Studies</b>	DPIE	DPIE	DPIE	DPIE	DPIE

**4.4 Allowable Floodplain Impacts**

The County does not encourage the addition of new structures or enlargement of existing structures in a floodplain. However, numerous existing structures remain in the floodplain. County Code Secs. 32-205, 32-206, 32-208, and the zoning and subdivision regulations provide detailed guidance for allowable impacts within floodplain areas and their associated constraints or development requirements. The following specifics outline allowable floodplain impacts:

- A. With the exception of SWM facilities and road crossings, structures shall not be built that would interfere with flood conveyance capacity. Any flood elevation increases resulting from the construction of SWM facilities shall require an additional floodplain easement.
- B. Existing structures in the floodplain may be flood proofed, but not otherwise expanded, provided this does not raise the flood elevation, per County Code Sec. 32-205.
- C. Flood studies must indicate whether any portion of the site lies within the danger reach of any existing or planned upstream dams. Where the project site overlaps a danger reach, the danger reach must be delineated on the floodplain plan, and all new structures must be located outside the danger reach. For information about danger reach preparation, see the PGSCD *Soil Erosion and Sediment Control Pond Safety Reference Manual* (PGSCD Reference Manual).
- D. New residential development lots are not permitted within designated floodplain areas, except for lots in Zones RR, RE, RA, or OS. There are specific criteria to be met if lots in these zones are located in a floodplain per County Code Sec. 24-129(a).
- E. Floodplain fill is generally discouraged in the County. However, fill may be allowed under certain instances. For all proposed fill (permanent or temporary) within the existing 100-year floodplain, an SDCP approval must be obtained. At least an equal

amount of compensatory floodplain storage is required to mitigate proposed floodplain fill in accordance with County Code Sec. 32-205(g). There is no requirement to exceed a 1:1 ratio. See Sections 4.6 (c) and 4.11 of this document for road crossing information. A site plan with detailed grading and computations showing a balance of cut and fill shall be provided. The impact must minimize disturbance of the floodplain and respect environmental features.

#### 4.5 Permitting Floodplain Impacts

A permit is required by the County for any development activity affecting the floodplain area, including, but not limited to:

- A. Construction of and/or substantial improvements to buildings and structures
- B. Placement of manufactured homes or buildings
- C. Placement of fill material
- D. Temporary development
- E. New or replacement infrastructure
- F. Any combination of the above

County Code Sec. 32-209 includes the specific criteria for applying for a permit, construction inspection, and/or issuance of a use and occupancy permit. Obtaining a permit from the County does not relieve the applicant's responsibility for obtaining approval from MDE or FEMA for impacts to the floodplain or waterway.

#### 4.6 Delineation of Floodplain - GIS-based Floodplain Submittals

The procedure and required information to request a GIS-based floodplain study to be conducted by the County are summarized below. See Appendix 4-2 for a flowchart of the floodplain review process.

- A. Submit a written request to the DPIE, requesting that the County prepare a floodplain study, using the GIS-based H&H models. The applicant shall submit this request on a tax map with the area of interest highlighted. This request should include the submittal checklist available on the County DPIE website, with the required submission form that is available in Appendix 4-3 of this document.
- B. Once a request is received, along with the floodplain study fee (see Chapter 3 for Fee Schedules), the request will be logged in by DPIE and assigned a floodplain study number. This request will be forwarded from DPIE to the DOE Sustainable Initiatives Division for review. If the submittal package is missing any required information, a study will not be completed and the package will be returned to the applicant.



- C. The County will review the original request and in some cases additional information may be required before the study can be completed. The County Engineer will notify the applicant and request the additional information. The existing or proposed stream crossing information necessary to complete the study could include:
1. Road profile
  2. Minimum road elevations
  3. Number of pipes
  4. Pipe/culvert dimensions
  5. Pipe material and type
  6. Upstream and downstream maximum low chord elevations of each pipe
  7. Upstream and downstream stream invert elevations of each pipe
  8. Length of pipe/culvert
  9. Number of piers
  10. Pier shape
  11. Width of piers
  12. Headwall or wing wall type

The information provided must be field surveyed and provided to the County for modeling using the County-acceptable North American Vertical Datum of 1988 (NAVD). In addition, if there is a proposed stream crossing, the location should be clearly shown on the plan.

- D. If the study involves a balance of cut and fill, the area of cut, as well as fill, must be clearly defined with proposed grading/contours. The calculations showing cut and fill volumes must also be provided.
- E. Once a study is complete, a letter identifying floodplain elevations at cross sections and required freeboard, along with a map of the floodplain cross section locations, will be sent to the design consultant. The County's GIS 2-foot topography is used; therefore, 2 feet of freeboard will be added to all elevations.
- F. Upon receipt of the letter from the County, the applicant has the option to provide more detailed topography, such as field-gathered survey information or aerial photography with a contour accuracy of 2 feet, with the original cross-section location shown on the new topography. In addition, the station and elevation for the cross section will also be provided to the County. The new cross-section data will be input into the County model and revised elevations will be generated. A new approval letter with the elevations will be provided and no freeboard will be required.
- G. The applicant will plot the cross-section locations and delineate the floodplain on a 2-foot contour topography plan and submit it to DPIE for review and approval. Unless

otherwise directed, 2 feet of freeboard will be added to the County-provided elevations. See Appendix 4-4 for a sample approval block.

- H. Both FEMA and MDE will accept County-approved, GIS-based floodplain studies.

#### 4.7 Delineation of Floodplain - Previously Approved Studies:

If the County determines that the FIRM is appropriate to use, 1 foot of freeboard will generally be added to the FEMA elevations for the delineation on the property when using 2-foot, or more accurate, topography. At the time a request is made to the County, the County will make a determination of which floodplain elevations to use.

If a County Watershed Study is used, no freeboard will be added to the studies for the Anacostia River, Bear Branch, Crow Branch, and Beaver dam Creek. For all other County Watershed Studies, the applicant must add 1 foot of freeboard to the WSEL for the plotting of the floodplain on applicant-supplied 2-foot or more accurate topography. **The applicant must confirm the vertical datum of the background study and apply a vertical adjustment factor to translate the flood elevation into the project datum, which is typically based upon NGVD 1929.**

To simplify County review, any existing study with elevations to be delineated on new topography shall use the floodplain elevation line adjusted to the datum so County staff can overlay it on the plan to verify the delineation. For example, if the County study has an elevation of 113 feet referenced to NGVD on a study in the 1929 datum, the floodplain study map should be overlaid on the new plan, the location of the elevation noted, and the elevation adjusted to 112.22. The floodplain boundaries are then delineated based on the new elevation.

#### 4.8 Delineation of Floodplain - FEMA Floodplains

If a property is in the FEMA floodplain, any modifications including expanding a structure, placement of fill, construction of new or modified crossings, etc., require submission of a study to FEMA to verify that the impacts are acceptable. This submittal is a Conditional Letter of Map Revision (CLOMR)

Any modifications must be initially reviewed and accepted by the County before forwarding to FEMA for final review and approval.

The elevation information provided by FEMA is referenced to vertical datum NGVD 1929. The NGVD 1929 value is 0.78 foot higher than NAVD, 1988 used by the County. The WSSC also uses NGVD 1929 for datum.

In addition, any proposed stream crossing locations should be clearly shown on the plan.

#### 4.9 Delineation of Floodplain - Private Consultant Engineering Studies

A floodplain study may be prepared by a design consultant for either existing or proposed conditions subject to the following criteria.

- 
- A. The design consultant must first confirm that a previously approved study does or does not exist by contacting the County.
  - B. Design consultant prepared floodplain studies shall be consistent with applicable State and Federal regulations. For example, the WSELs as shown on the FEMA FIRMs will be the minimum acceptable WSELs for existing channel conditions. (Subject to approval by DPIE)
  - C. Floodplain studies must be prepared by a Registered Professional Engineer licensed to practice engineering in Maryland and must be sealed, signed, and dated.
  - D. Floodplain studies must conform to the criteria published herein.
  - E. Floodplain studies must conform to other requirements as directed by DPIE.
  - F. Floodplain studies and supporting data will become property of the County.
  - G. Floodplain studies must be based on the 100-year flood event.
  - H. Floodplain studies must be based on the ultimate land use conditions as specified in the most updated zoning map/sectional map amendment within the watershed. The ultimate land use for State or Federal property is included in a master plan prepared by the State or Federal institution. The engineer shall coordinate with the institution to acquire a copy of the latest master plan.
  - I. Floodplain studies for streams with a drainage area of less than 50 acres are typically exempted from the requirements of these criteria unless determined by the County to extend further upstream, per County Code Sec. 32-209 (a). Therefore, floodplain studies may be extended further upstream for the following reasons.
    - 1. The upstream property limit is within 100 feet of the 50-acre limit;
    - 2. A road crossing is within 200 feet of the 50-acre limit.
    - 3. If noted on the SDCP approval letter, a floodplain study for less than 50 acres is required.
  - J. Floodplain studies must be based on actual existing channel geometry obtained from either field survey, 2-foot contour, or more accurate aerial topographic information. Assuming that sedimentation or scour may occur during the storm event is unacceptable.
  - K. Floodplain studies must provide valid hydrologic analysis of rainfall, runoff, and conveyance.
  - L. If storage effects are significant, volume as well as peak flow must be evaluated.
  - M. Floodplain studies must consider backwater conditions, local obstructions, and, where required by the DOE, the partial or complete failure of any enclosed drainage system.

(Consideration must be given to the overflow path to ensure that no structure will flood in the event of system failure.)

- N. No freeboard is required for a study prepared by a design consultant if the topography is by field-gathered survey or utilizes aerial topography with 2-foot contours or better.
- O. The information provided must be field surveyed and tied into the existing County topography datum of NGVD or NAVD depending on the vertical datum of the County floodplain study. In addition, any proposed stream crossing locations should be clearly shown on the plan.

#### 4.9.1 Data Required for Private Consultant Engineering Studies

Sufficient information on the impact of the project on FEMA floodplains or a consultant-prepared floodplain must be provided for County acceptance. In addition, if there are proposed impacts to FEMA's floodplains the report shall also address FEMA requirements. Information on requesting a LOMA or LOMR may be found at

[Amendment-Letter-Map-Revision-Based-Fill-Process](#)

The following items are needed from the applicant when a floodplain study is submitted to DPIE for review:

##### 4.9.1.1 Report

The report should include a general description of the project and a written summary of the methodology. At a minimum, the following information is needed within the report. In addition, appendices containing the H&H shall be included.

- A. Floodplain Review Submission Form - Indicate permits or approvals sought (such as building, grading, site plan, final plat, MDE, FEMA, etc.);
- B. Brief description of existing site conditions, including location and vicinity maps. Indicate the availability of existing studies (FEMA, MSHA, County, etc.);
- C. A detailed description of proposed site conditions, including a copy of the Approved SDCP and Approval Letter;
- D. If channel modifications are proposed, include a copy of design plans;
- E. Explanation of all assumptions made in computations. Provide reference for the computational procedures and equations taken from manuals, books, etc. What the design consultant may perceive as obvious may not be obvious to the reviewer;

- F. Source of the HEC-2/HEC-RAS cross-section information. (Field survey or topographic map, etc.);
- G. Methodology for determining the starting WSEL;
- H. Ranges of Manning's "n" values for channel and overbanks, any assumptions used, and a statement on how "n" values were determined;
- I. Summary of Elevations table for existing and proposed conditions;
- J. All existing and proposed channel conditions cross sections and profiles;
- K. Site Plan with detailed grading for any proposed fill;
- L. A cut-fill balance if floodplain fill is proposed;
- M. Discussion of any environmental impacts caused by the proposed floodplain impacts; and
- N. Any other pertinent information that will aid reviewers in expediting the review process (computer disks, correspondence, intra/inter-agency agreements, etc.)

#### 4.9.1.2 Hydrology (For TR-20)

To calculate peak flows and route those flows through multiple drainage areas, DPIE accepts the Natural Resources Conservation Service (NRCS) TR-20 computer program. The program, user documentation, training materials, etc., may be found at:

[NRCS WinTR-20 Watershed Hydrology](#)

- A. Drainage Area Map: The drainage area maps should show existing and proposed topography with the sub-watersheds delineated. The M-NCPPC's topographic map may be used. When M-NCPPC topography is not available, U.S. Geological Survey (USGS) maps may be acceptable. The map shall identify each sub-watershed area and the flow path used for Tc calculation, with segments labeled for both existing and proposed channel conditions.
  - 1. The 50-acre point shall be identified on the map, if applicable.
  - 2. The total drainage area shall be identified for all streams and channels at the point of entry, and exit to and from the site.
  - 3. The minimum sub-area shall be 0.01 acre, but results should be verified for any area less than 1 acre. TR-55 will allow a sub-area up to 25 square miles.

- B. Runoff Curve Numbers: The Runoff Curve Number (RCN) shall be computed based on land use information obtained from the most recent zoning map/sectional map amendment, or by utilizing the proposed development plan for the on-site area. The land use will overlay the hydrologic soil group based on the latest edition of the County's Soil Survey for the calculation of curve number. The assumption that the land will remain undeveloped is unacceptable. See Win TR-55 for the curve numbers for land use combined with hydrologic soil group. The latest Windows version of TR-55 may be found at:

[NRCS Science and Technology Conservation Tools Software](#)

[Prince George's County Soils Survey](#)

- C. Time of Concentration (T<sub>c</sub>): The travel time method should be used following the procedures outlined in Chapter 3 of the June 1986 edition of *TR-55 Computations*, with a maximum sheet flow length of 100 feet. The January 2009 version of the TR-55 User Guide may be found at:

[Small Watershed Hydrology NRCS WinTR-55 User Guide](#)

1. The flow path and segments used to determine the T<sub>c</sub> for each sub-watershed should be clearly identified on the drainage area map.
2. The 24-hour rainfall amount for the 100-year storm event in the County is 8.49 inches. Therefore, P<sub>2</sub> in the NRCS T<sub>c</sub> equation shall be P<sub>100</sub> (8.49") shall be used.
3. Use rainfall distribution Table II and Antecedent Moisture Condition II.
4. Manning's "n" factor for sheet flow should reflect ultimate land use conditions (for existing and proposed channel conditions).
5. Shallow concentrated flow shall be used until a channel is encountered. In some circumstances grading changes caused by mining operations or other large earth moving operations may have disturbed the natural channel. Longer than usual shallow flow lengths may be appropriate in those circumstances.
6. Computations must be provided for determination of channel flow velocity based on stream channel bank full conditions (generally the 1- or 2-year storm event).

7. As a last resort, the velocity may be obtained from HEC-2, HEC-RAS, or HY-8 using at least the estimated 2-year discharge.
- D. Hydrologic soil group boundaries shown on drainage area map;
  - E. Zoning map/sectional map amendment with sub-watershed boundaries drawn on drainage area map;
  - F. The ratio of the largest sub-drainage area to the smallest sub-drainage area shall not exceed 5:1 without permission from the DOE.
  - G. Rating Tables for Channel Routing
    1. Rating tables for stage-discharge and stage-end area relationships (reach routing) should be generated from a reliable hydraulic analysis such as HEC-2/HEC-RAS modeling. Identify sections used for the rating table.
    2. Using Manning's equation to determine stage-discharge relationship is not acceptable because it assumes that backwater effects do not exist.
    3. Rating tables must be adjusted to reflect proposed channel conditions.
  - H. Rating Tables for Reservoir Routing
    1. Stage-discharge computations can be generated by using HEC-2, HEC-RAS, HY-8 or the Federal Highway Administration (FHWA) HDS No. 5.
    2. Stage discharge computations for reservoir control structures must (where applicable) take into account submergence of weirs, slots, and orifices due to tail water conditions. (see Chapter 9 of this document for more detail)
    3. The most recent and updated topographic information should be used to determine stage-storage relationship. M-NCPPC's 2-foot topographic map is the minimum required. If field gathered survey or other aerial 2-foot topographic maps are available, they should be used.
    4. The elevation interval between A1 and A2 should not be greater than 2.0 feet when the following equation is used to estimate available storage:

$$S = ((A1 + A2)/2) \times H.$$

Where: A1 = Area of First Contour

A2 = Area of Second Contour

H = Difference between the Two contours

5. The 100-year elevation calculated from the TR-20 and the predicted flood elevation calculated from the hydraulic model must be within 0.10 foot.
  6. Rating tables must reflect the proposed channel conditions.
- I. Storm Events: Recently, the National Oceanic and Atmospheric Administration (NOAA) issued updated guidance for the County that increased the 24-hour, 100-year storm rainfall to 8.49". See *PGSCD Reference Manual* for rainfall amounts for other storm frequencies. Use Rainfall Distribution Table II and Antecedent Moisture Condition II.
- J. Stormwater Management Ponds: Publicly maintained storm water ponds in the development that significantly affect the 100-year discharge should be included in proposed channel condition H&H.
- K. The existing and proposed channel condition models should be as consistent as possible so the 100-year discharge can be compared at study points.
1. For example, an existing channel condition model with two sub-areas and a proposed channel condition model with eight sub-areas are not acceptable. The discharge computed for existing channel conditions should be compared to discharge computed for proposed conditions at the downstream property line.
  2. Should the proposed channel conditions discharge be greater than the existing channel conditions discharge, the floodplain study must be extended at least 500 feet downstream of the site to determine the increase in the 100-year floodplain elevations.
  3. Computations based on existing land use and storms other than the 100-year event are not required for 100-year floodplain submittals. FEMA discharges are based on existing conditions and should not be used for SWM facilities.
- L. Sub-areas shall end at a storage structure in the hydrology model. Modeling the use of an SWM facility in the middle of a sub-area is not acceptable.



- 
- M. Roads, railroads, or other constrictions may be used to attenuate flow. To be used, the crossing must pass the 100-year storm without overtopping, unless approved by DPIE in advance.
- N. Watershed Schematic for TR-20.
- O. TR-20 Standard Control
1. The “network” must be reflective of the drainage area maps.
  2. Reach lengths should reflect the floodplain length if flow is primarily overbank, and channel length if flow is primarily in the channel. Reach lengths used in the TR-20 must agree with those shown on topographic maps and reflected in the HEC-2/HEC-RAS analysis.
  3. Input data used in the TR-20 must be consistent with the back-up calculations generated for:
    - Drainage Area
    - RCN (based on ultimate land use conditions)
    - Tc
    - Rating Tables for both Channel & Reservoir Routings
  4. Final drainage areas generated by TR-20 must reflect actual watershed drainage areas.
- P. Computer disk of TR-20 files for the project (if deemed necessary).

#### 4.9.1.3 Hydraulics - General

The County has used the USACE HEC-2 computer program for many years for County-prepared watershed studies. The USACE has replaced the HEC-2 with a new computer-based program, HEC-RAS. If there is a need to use the legacy HEC-2 software, it may be obtained from the following website.

[USACE HEC-2 Software Program](#)

- A. Cross Sections - Cross sections shall be created from field surveys or 2-foot topography. M-NCPPC GIS topography with 2-foot contours is also acceptable. They shall be perpendicular to flow. It should be noted that M-NCPPC GIS topography is based on NAVD 1988, and the design consultant may need to adjust the study elevations to match the project topographic datum (typically NGVD 1929).

- B. Starting WSEL - When available, the known WSEL should be used as the starting WSEL. WSELs can be obtained from the following sources, whichever reflects the highest WSEL:
1. Most recently approved FEMA study with appropriate freeboard (with approval from DPIE). The current FEMA FIRM maps were prepared using the NGVD1929 datum. The design consultant will need to adjust the WSEL downward by 0.78' if the project datum is NAVD1988.
  2. Comprehensive Watershed Management Studies prepared by the County's Stormwater Management Technical Group (SWMTG) have been completed for Western Branch, Tinker's Creek, Piscataway Creek, Henson Creek, Oxon Run, Charles Branch, Beaver dam Creek, and the Anacostia River Watersheds. All of these studies were prepared using NGVD1929 datum. The design consultant will need to adjust the WSEL downward by approximately 0.78 feet if the project datum is NAVD1988.
  3. The design consultant should contact DPIE directly to inquire about the availability and acceptability of existing floodplain studies. The datum should be verified to see if an adjustment is needed. If a known WSEL is unavailable, the design consultant should extend the study downstream to the nearest structure (road, pond, etc.) that would have a backwater impact. As a last resort, the HEC-2 slope area method should be used to compute normal depth. When the slope area method is utilized, the study should be extended to ensure convergence of the WSEL. Generally, this will be a minimum of 1,500 to 2,000 feet downstream of the site. If the computed WSEL is assumed to be critical depth, the structure ( STRT) and WSEL on J1 card and/or Manning's "n" value should be adjusted to yield a non-critical depth elevation.
- C. Loss Coefficients
1. Manning's "n" values should reflect actual field conditions. The composite or equivalent coefficient of roughness of any cross section should not be averaged for the wetted perimeter of the cross section. Refer to *HEC-2 User's Manual* Version 4.6 revised September 1991, or FHWA HDS No. 5 for computation of composite Manning's "n" values.
  2. Proper expansion and contraction coefficients should be used. Adjust the value of loss coefficients at abrupt transitions in the channel reach.

3. If loss coefficients are used by station and not top of bank, the cross-section station must match the loss coefficient location.
- D. Bridge Modeling - Headwater elevation at bridges/culverts can be determined using the HEC-2 or HEC-RAS bridge routines, HY-8, other approved computer programs that calculate headwater, or hand computations. Due to their flexibility in handling different flow regimes, the County encourages the use of the HEC-2 or HEC-RAS bridge routines.
  - E. Proposed Channel Modifications - When channel modifications are proposed, a model must be prepared for both existing and proposed channel conditions. The models should extend upstream until the WSELs converge. Offsite areas affected by a water-surface rise must be acquired by the developer or reserved by the acquisition of suitable floodplain easements.
  - F. Supercritical Flow - For supercritical flow conditions due to large velocity head, the 100-year floodplain delineation should reflect energy grade elevations.
  - G. Floodplain maps indicating cross-section locations, flood elevations (existing and proposed) at each cross-section, floodplain boundaries (existing and proposed), proposed stream changes, etc. The topography shall be referenced to NAVD..
  - H. Computer disk consisting of input files for the project (if necessary)

#### 4.9.1.4 Hydraulics - HEC- 2

Specific information to be provided if HEC-2 is used to develop WSELs is as follows:

- A. Bridge Modeling. When using the HEC-2 bridge/culvert routines, the design consultant should pay particular attention to the following:
  1. The normal bridge routine should be used to model low flow or completely submerged conditions, while the special bridge routine should be used to model pressure flow or pressure plus weir flow conditions. (Note, GR & BT stations must match in low flow condition).
  2. The HEC-2 assumes outlet control flow condition. Inlet control flow condition should be checked using the FHWA HDS No.5 pipe/culvert charts. If inlet control governs, an accurate WSEL should be input into the model using an X5 card reflecting the energy grade line.

3. Top widths at the upstream and downstream face of the bridge must be reasonably encroached. For pressure or low flow conditions, top widths should be the same as the bridge opening. For weir flow, top width should not be limited to the bridge opening and velocity head should not be significantly greater than 0.5 foot at the upstream face of the bridge.
  4. A more detailed evaluation is required to verify adequacy of critical depth at bridge cross sections. For low flow or pressure flow conditions, modeling should reflect proper expansion of flow downstream of the bridge and contraction of flow upstream of the bridge (page IV-18, HEC-2 manual). When the Special Bridge Method is used, no critical depth is acceptable at the upstream face of the bridge/culvert.
  5. Computations must be provided for SB or SC card parameters. Net area of opening (BAREA) and computed trapezoid area should correspond.
  6. If storage is considered behind the bridge, the flood elevation calculated from the TR-20 run should be reasonably close to the energy grade calculated from HEC-2 (maximum difference of 0.1 feet). Should the design consultant prefer to determine headwater elevation using hand computations, the FHWA HDS No.5 pipe/culvert charts should be utilized. The outlet control charts assume pipe flowing full. Tail water shall be considered in analyzing outlet control. If hand computations are used, explain all assumptions (determination of weir coefficient, width of weir, and overflow height) and document references.
- B. Divided Flow - All notes and remarks in the HEC-2 output should be reviewed. Divided flow messages should be analyzed to ensure that this is the flow situation. If a divided flow condition occurs for three or more consecutive cross sections, then separate profiles should be run up each leg of the divided flow as WSELs are not necessarily identical at each cross section. Refer to *Application of HEC-2 Split Flow Option*, Training Document No. 18, April 1982, for methodology to solve island problems. The document may be found on the USACE website:
- [USACE Application of HEC-2 Split Flow Option](#)
- C. Critical Depth - When the program cannot balance the WSEL, critical depth is assumed for the cross section and a message to that effect is printed by the program. The consultant must verify the adequacy of all critical depth messages. The analysis should consist of:

1. Check coding of GR points
  2. Confirm location of bank stations to ensure they reflect actual field conditions. Locating the bank stations too far apart would result in the model computing excessive flow conveyance within the channel section, which generally has a lower Manning's "n" value.
  3. Additional cross sections may need to be inserted in order to preserve the assumption of gradually varied flow. Check top widths at cross sections for realistic transition of flow between cross sections.
  4. A sensitivity analysis for increasing Manning's "n" value for channel and overbanks. Computer runs should be included in the submission package.
  5. If a message occurs at numerous consecutive cross sections, the County may request that the program be rerun for supercritical flow conditions.
  6. Unresolved persistent messages should be documented with an explanation.
- D. Detailed bridge or culvert information including: bridge geometry such as opening, material, length, invert elevations, number of piers, pier type, etc.; back-up calculations for bridge or culvert parameters to include those used on SB or SC cards of the HEC-2 model; road profile; inlet control vs. outlet control computation
- E. The output data in the J3 card shall be code 150.

#### 4.9.1.5 Hydraulics - HEC-RAS

HEC-RAS is the latest water surface profile computer program prepared by USACE. There are three manuals used to prepare a HEC-RAS computer model. These may be obtained using the following USACE links:

[COE HEC-RAS 4.1 User's Manual](#)

[COE HEC-RAS 4.1 Applications Guide](#)

[COE HEC-RAS 4.1 Hydraulic Reference Manual](#)

Specific information to be provided if HEC-RAS is used to develop WSELs is as follows:

- A. Bridge/Culvert Modeling - When using the bridge/culvert routines, the design consultant should pay particular attention to the following:

1. The first and last cross sections should be located sufficiently up and downstream of the bridge/culvert so that the flow is not affected by the structure. A cross section should be placed within a few feet up and downstream of the structure.
  2. A more detailed evaluation is required to verify adequacy of critical depth at bridge cross sections. For low flow or pressure flow conditions, modeling should reflect proper expansion of flow downstream of the bridge and contraction of flow upstream of the bridge (see Appendix B of the *HEC-RAS Hydraulic Reference Manual*). Computations must be provided for expansion and contraction reach lengths.
  3. If storage is considered upstream of the bridge, the flood elevation calculated from the TR-20 run should be reasonably close to the energy grade calculated from HEC-RAS (maximum difference of 0.10 feet). Should the design consultant prefer to determine headwater elevation using hand computations, the FHWA HDS No.5 pipe/culvert charts should be utilized. It is emphasized that the outlet control charts assume pipe flowing full. Tail water shall be considered in analyzing outlet control.
- B. Divided Flow - All notes and remarks in the HEC-RAS output should be reviewed. Divided flow messages should be analyzed to ensure that this is the flow situation. If divided flow conditions occur for three or more consecutive cross sections, then separate profiles should be developed or modeled for each segment of divided flow, as WSELs are not necessarily identical at each cross section. Refer to "HEC-RAS Applications Guide" Version 4.1, January 2010, and Chapter 15 of this document for methodology to solve island problems.
- C. The minimum information to be provided for the detailed output for HEC-RAS is the "Profile Table - Standard Table 1" and "Errors warnings and notes for plan." If DPIE requires additional information, a request will be made after the first review. In addition, the cross-section plots and detailed input data will be submitted.

#### 4.9.2 Conservative 100 Year Floodplain Delineation

When all review comments have been addressed to DPIE's satisfaction, a floodplain approval letter for existing channel conditions will be released.

Following the first submission of a floodplain study for existing channel conditions, if the site meets the following conditions, DPIE will allow a freeboard to be added to the WSELs predicted by the submitted study so only one submittal is required. These conditions are:

- A. Drainage areas between 50 acres and 150 acres.
- B. Proposed developments (building and disturbed areas) are substantially higher than any existing watercourses. This freeboard will be established by DPIE depending on the accuracy of the submitted study. If the proposed freeboard is not acceptable to the applicant, a revised study may be submitted that addresses all review comments.

#### 4.10 Floodplain Fill

For all proposed fill, either permanent or temporary, within the existing 100-year floodplain, the following items must be submitted for review and approval:

- A. SDCP approval must be obtained for the proposed fill or other impacts to the floodplain.
- B. At least an equal amount of compensatory floodplain storage is required to counter-balance proposed floodplain fill except for road crossings (Subtitle 32 Division 4). There is no requirement to exceed a 1:1 ratio. See "F" below for road crossing information. A detailed grading plan and computations showing a balance of cut and fill shall be provided. The impact must minimize disturbance to the floodplain and respect environmental features.
- C. The floodplain cut and fill must be reflected on the cross sections in the hydraulic model.
- D. Proposed fill and compensatory storage cannot result in an increase in offsite upstream WSELs unless an easement is obtained.
- E. A detailed hydraulic analysis is required to determine the impacts of the proposed fill.
- F. Floodplain fill for embankments of road crossings or SWM facilities is acceptable without requiring compensatory storage. (County Code Sec. 32-205 [g]). Any increase in elevation requires determination that the floodplain is within an easement. Any increase in the floodplain for off-site property requires an easement from the property owner.
- G. If the proposed floodplain fill is located within the floodplain limits shown on the FEMA FIRM, then a FEMA map revision process will be required.
- H. If proposed impacts to a FEMA floodplain are identified, the report shall also address FEMA requirements. Information for processing a LOMA or LOMR may be found at:

[FEMA Amendment & Letter of Map Revision Based on Fill Process](#)

[and](#)

[LOMR Process](#)

#### 4.11 Floodplain Buffer

According to County Code Sec. 32-204(d) floodplain buffers may be requested.

- (d) *Floodplain buffer area - where proposed development is associated with a stream or tributary and the limits of the floodplain cannot be accurately determined because of the lack of detailed floodplain data and analysis or because of unknown effects of future development in the watershed, the Department may require that a floodplain buffer be established and maintained as part of the development.*

Generally, this will require a maximum buffer of 50 feet from the residential zoned property building restriction line (both fee simple and non-fee simple lots) to the floodplain limits, and a maximum 25-foot buffer for the building restriction line for commercial or industrial zoned lots

#### 4.12 Floodplain Easements

After approval of the 100-year floodplain plans, the applicant must provide easements on the subject property to protect delineated floodplain areas. Please note the following requirements:

- A. Offsite Easements: Areas outside the property limits that are affected by any water surface rise resulting from the development, must be acquired by the applicant or reserved by acquisition of suitable floodplain easements.
- B. Easements on Record Plats: Grant of the floodplain easement limit at the time of final plat, with a written legal easement document recorded amongst the Land Records of Prince George's County, Maryland, setting forth the rights, responsibilities, and liability of the parties as a part of the SWM plan approvals. The final plat will note that an easement document may be required by the County and recorded in land records prior to approval of the technical SWM. This requirement also applies to proposed public parks or recreation areas maintained by a designated responsible public agency. Floodplain areas already dedicated or owned by the M-NCPPC will not require an easement.
- C. Standard Easement Language: A floodplain easement document shall be recorded in the land records of the County and the liber and folio of that document reflected on the final plat when available at that time. The standard language developed by the County for the easement boilerplate shall be used. No substitutions will be allowed unless approved by the County Office of Law. An easement dedication document denotes that the floodplain easement may be used for utility lines, storm drainage facilities, open-type fencing, passive recreation, or SWM facilities and shall include provisions for ingress and egress, where practicable.

#### 4.13 Floodplain and Net Tract Area

Based on studies meeting the criteria herein, floodplain areas must be used to determine the net tract area or net lot area. The floodplain areas of streams having watersheds of less than 50 acres may be excluded from the floodplain area computation (County Code Sections 24-129(c) and 27-124-01).



This Page Intentionally Left Blank

---

## Chapter 5 SITE DEVELOPMENT CONCEPT PLAN

### 5.1 Purpose, Jurisdiction, and Process

#### 5.1.1 Purpose and Jurisdiction

The purpose of the SDCP)is to ensure that water quality control, quantity control, and proper disposition of storm water are considered early in the planning stage of the development process. All land development activities (including expansions, additions, and redevelopment) in the County, except those with approved plans from the City of Bowie, or on State or Federal land approved by the associated State or Federal agencies, must have an SDCP approved by the County DPIE unless the exemption requirements specified in Section 5.1.4 are met.

#### 5.1.2 The MDE's Three-Phase Comprehensive Review Process

The SWM Act of 2007 requires the MDE to establish a comprehensive review process. The three-phase process that resulted is outlined in COMAR 26.17.02.09, which went into effect on May 4, 2010. The SDCP is the first step of this three - phase process. It was adopted by the County as part of Subtitle 32 Division 3, from Council Bill-15-2011. Implementation of the requirements in Subtitle 32 will lead to approval of final design plans and permits for construction of SD and SWM facilities. Phase Two (Site Development Plan) and Phase Three (Final Plan) of the MDE process are discussed in Chapters 6 and 7, respectively.

All new development projects shall be subject to the Design Process for New Development as outlined in the stepwise procedures in the *Maryland Design Manual*, Figure 5-1 . The design process requires review and approval during three different phases of project planning that include the SDCP, Site Development Plan, and Final Plan stages. As required by the SWM Act of 2007 and the County Code, an applicant shall demonstrate that an ESD has been implemented to the MEP before the use of a structural BMP is considered.

Structural practices (as defined by MDE) may be used in conjunction with ESD to the MEP to capture the required amount of ESD volume ( $ESD_v$ ). On occasion, specific conditions (i.e., Marlboro Clay soils) may preclude using ESD to the MEP approaches , in which case structural BMPs may be used. In these types of cases, it is the applicant's responsibility to justify that such conditions do, in fact, exist in the early stages of the development process. For redevelopment projects, ESD to the MEP considerations may be found in Section 5.2.6 of this document.

The County has established a coordinated approval process among all appropriate local agencies. Other review agencies involved include PGSCD and M-NCPPC. They will provide comments and DPIE will issue approvals during each of the following phases of plan development, although other agencies may

also issue their own approvals, particularly at the Final Plan stage. For SWM, the three-phase process includes the following steps:

- A. Concept Plan (e.g., DPIE Site Development Concept Plan and PGSCD Concept Grading, Erosion, Sediment Control Plan)
- B. Site Development Plan
- C. Final Plan (e.g., Construction Drawings or Permit Drawings)  
At each phase of this review process, the applicant and the design team will receive feedback provided by the agencies, allowing the applicant to incorporate any concerns and recommendations throughout project planning and design. The SDCP will include site resource mapping and protection, and conservation strategies to be incorporated into the design. The applicant's design team will also provide preliminary SWM calculations for nonstructural and structural devices or facilities. Review of the SDCP will ensure that important resources have been mapped, protected, and all opportunities to enhance natural areas have been explored early in the design process.

The design process and planning techniques described in this chapter provide guidelines for protecting natural areas, minimizing imperviousness, using available landscaping for ESD practices, and integrating storm water and erosion and sediment control strategies. Following this process will achieve the goal of implementing ESD to the MEP. Involving all review agencies from the beginning of the site planning process through the more detailed design phase will foster feedback and allow for a more efficient review and approval of final plans.

### 5.1.3 First Phase - Site Development Concept Plan

This chapter outlines the process for preparing an SDCP and how the plan will be reviewed by the various County agencies. This includes the policies for determining if the project meets ESD to the MEP. For redevelopment projects, this may include incentives for providing additional water quality treatment on projects to assist the County in meeting its Phase II Watershed Implementation Plan requirements mandated by the EPA.

The DPIE Site/Road Plan Review Division will review the application and make a determination if the plan is complete or if additional information is needed in order to confirm that ESD to the MEP has been met. A separate Concept Grading, Erosion, Sediment Control Plan will be concurrently reviewed by PGSCD, and an NRI will be concurrently reviewed by the M-NCPPC. When streams with a drainage area of 50 acres or more are involved, a floodplain study will be required. The floodplain study process may be started by contacting DPIE for existing studies or requesting a study to be prepared by DPIE/DOE. Further information about the floodplain designation process may be found in Chapter 4

of this document. All three agencies (DPIE, PGSCD, M-NCPPC) will share these plans to ensure a coordinated referral. These agencies will review the plans and provide comments at the M-NCPPC Subdivision and Development Review Committee (SDRC) meeting.

Once DPIE is satisfied that SDCP comments have been satisfactorily met, a SDCP approval will be issued. The SDCP cannot be approval until after the NRI is approved. The approval letter will also contain conditions to be met at the subsequent stages of the design process. For entitlement projects, DPIE will forward the SDCP approval letter to M-NCPPC to be included with the Preliminary Plan of Subdivision staff report. The SDCP approval is generally required prior to the Planning Board hearing for a Preliminary Plan of Subdivision, Comprehensive Design Plan, etc., which are processed by M-NCPPC.

The PGSCD will issue their approval of the Concept Grading, Erosion, and Sediment Control Plan after DPIE approval has been issued. See the *2013 Soil Erosion and Sediment Control – Pond Safety Reference Manual* (PGSCD Reference Manual) for additional information.

#### 5.1.4 Exemptions

Certain projects are not required to meet the storm water requirements. Although a project may be exempt from storm water requirements, most projects must secure a SDCP approval. The following development activities are exempt from the provisions of County Code Sec. 32-174:

- (a) *Except as provided in Subsection (b), the following development activities are exempt from the provisions of this Division and the requirements of providing storm water management:*
  - (1) *Agricultural land management practices;*
  - (2) *Additions or modifications to existing detached one-family dwellings provided that they comply with item (3) of this Subsection; and the subject site does not exceed the maximum allowable lot coverage allowed in Section 27-442 (c) Table II – Lot Coverage and Green Area or Section 27-445.12(a)(3) Table 2 Maximum Net Lot Coverage, whichever applies.*
  - (3) *Any developments that do not disturb more than five thousand (5,000) square feet of land area;*
  - (4) *Developments within the City of Bowie where the city has approved storm water management design plans for a development either on or off the development site, which otherwise meet or exceed the provisions of this Division;*

- (5) *Land development activities which the Administration determines will be regulated under specific State laws that provide for managing storm water runoff.*
- (b) *Where the property is located within a Chesapeake Bay Critical Area Overlay Zone, the development activities in Subsection (a), above, except for agricultural land management activities, shall comply with the storm water management requirements of this Division and conform with the requirements of Subtitle 5B, and a Conservation Plan shall be required relating to the storm water management activities. In all cases, the development activities located within the Chesapeake Bay Critical Area Overlay Zone, and are required to comply with storm water management requirements, shall meet the requirements of this Division and conform to the requirements of Subtitle 5B.*

### 5.1.5 Variance

The Department may grant a variance from any requirement of Subtitle 32, if there are exceptional circumstances, such that strict adherence will result in unnecessary hardship and/or will result in a project not in compliance with the intent of County Code Sec. 32-176. A written request for a variance shall be provided to the Director, stating the specific variance sought and the justification. The written request shall include descriptions, drawings, and any other information that is necessary to evaluate the proposed development and its impacts on receiving drainage systems, streams, and adjacent properties.

This variance request shall address the water quality and quantity control requirements. The granting of a variance of one type of control function (e.g., quantity control) will not release the applicant from the obligation of providing other types of control (e.g., water quality). The cumulative effect of all variances and waivers in a watershed shall be evaluated when determined to be appropriate by DPIE.

The Department shall not grant a variance unless and until sufficient justification is provided by the applicant showing that implementation of ESD to the MEP has been investigated thoroughly. The Department, in accordance with County Code Sec. 32-176, will also provide notice to the Council. The justification shall explain why the requirement of the Subtitle 32 cannot be met and the reasons why the alternative practices cannot be provided.

To obtain a variance, the applicant must conclusively demonstrate that one or more of the following are met, as appropriate to the project's location:

- A. The proposed development will not cause an adverse impact on the receiving wetland, watercourse, or water body; or
- B. The site is completely surrounded by existing developed areas that are served by an existing network of public storm drainage systems of

adequate capacity to accommodate the runoff from the additional development; or

- C. Direct tidewater outfalls are controlled so that the drainage area is managed in accordance with County and MDE water quality standards; or
- D. The hydraulic characteristics of the receiving stream and the watershed, and the water quality and environmental characteristics of the stream and the site, are such that on-site water quantity controls are not necessary to satisfy the objectives of stream channel erosion prevention and storm replication; or
- E. No downstream flooding problems will be created or aggravated by future development.

#### 5.1.6 Standard Concept Plan

In certain circumstances the preparation of the SDCP and the detailed supporting data are not required for a smaller project, but will require ESD to the MEP. Therefore, the County has adopted a "Standard Stormwater Management Plan." The form was originated by MDE and is applicable only when:

- A. A single family residential lot is not in a developing subdivision and no contiguous land is undergoing development by the same owner, builder, or developer.
- B. The disturbed area is less than 30,000 square feet, and
- C. Imperviousness is less than 15%.

If the project does not meet the conditions in the application, the more detailed process for a SDCP will be required. For only these projects, this form in conjunction with the PGSCD Standard Sediment Control Plan may be used. PGSCD will require approval of the DPIE Standard Concept Plan prior to PGSCD approval of the Standard Sediment Control Plan. A copy of the DPIE form and other limiting conditions may be found in Appendix 5-1.

#### 5.1.7 Alternate Requirements for Chesapeake Bay Critical Area

The Chesapeake Bay Critical Area (CBCA) has requirements that predate the SWM Act of 2007 and must also be considered when a project is within this area. The additional requirements are stated in County Code Sec. 32-174(b);

*"Where the property is located within a Chesapeake Bay Area Overlay Zone, the development activities in section 5.1.4, except for agricultural land management activities, shall comply with the storm water management requirements of this subtitle 32 and conform with the requirements of Prince George's County Code, Subtitle 5B, and*

*a Conservation Plan shall be required relating to the storm water management activities. In all cases, the development activities located within the Chesapeake Bay Critical Area Overlay Zone are required to comply with storm water management requirements, shall meet the requirements of this Division and conform to the requirements of Subtitle 5B”.*

For location of the limits of the CBCA, see [PGAtlas](#).

Projects located within the CBCA must meet the requirements of:

- A. *Prince George's County CBCA Program. A Property Owner's Guide, September 1990 (DER), and*
- B. *Critical Area and You: The Chesapeake's First Line of Defense.*

CBCA Commission  
45 Calvert Street, 2nd Floor  
Annapolis, MD 21401

### 5.1.8 Administrative Waivers and Exemptions

#### A. SWM Exemptions:

1. Agricultural land management practices are not governed by Maryland COMAR 26.17.02.01. Therefore, agricultural land management practices are exempt from providing SWM in accordance with County Code Subtitle 32-§174. A site development concept approval or subsequent SWM approvals are not required to be issued by the DPIE for these sites.
2. Additions or modifications to existing single-family detached residential structures, if less than 5,000 square feet of disturbance, are exempt from providing SWM, in accordance with COMAR 26.17.02.05 B. A standard site development concept approval is required for these sites. This approval is a simplified, fast-track process for the purpose of evaluating existing drainage problems; identifying the need for corrective work to resolve drainage problems; ensuring that proposed construction does not result in drainage problems; and identifying requirements related to floodplains, buffers, tree conservation areas, storm drain easements, fee-in-lieu, or roadway improvements.
3. Any developments that do not disturb more than 5,000 square feet of land area are exempt from providing SWM in accordance with COMAR 26.17.02.05B. A standard site development concept approval is required for these sites. This approval is a simplified, fast-track process for the purpose of evaluating existing drainage problems; identifying the need for corrective work to resolve drainage problems; ensuring that proposed construction does not result in drainage problems; and identifying requirements related to floodplains, buffers, tree conservation areas, storm drain easements, fee-in-lieu, or roadway improvements.

4. Quantitative Waiver: Projects that have direct discharges to tidally influenced receiving waters are waived from quantitative SWM control in accordance with Maryland COMAR 26.17.02.05.C.(3)(a). A site development concept approval is required for these sites.
- B. Alternative Stormwater Management Requirements
1. CBCA projects located in an Intense Developed Area are governed by COMAR 26.17.02.01. As such, these projects must also comply with the 10% pollution reduction requirements of COMAR 27.01.02.03D (3) and adhere to the requirements set forth in the CBCA Program. A conservation plan approval is required for these sites, processed through the M-NCPPC. An SDCP approval is required for these sites. Subsequent SWM approvals are required for these sites if the sites include non-CBCA land.
  2. For all SWM-exempt activities, erosion and sediment control regulations still apply.
  3. Applicants seeking a SWM exemption must provide evidence of compliance with the above. The County reserves the right to impose additional SWM controls if found to be warranted because of existing drainage problems.
- C. Stormwater Management Administrative Waivers and Sunset of Waivers
1. In accordance with COMAR 26.17.02.01-2, projects that secured certain identified approvals prior to May 4, 2013, are eligible for an administrative waiver. Approvals must include:
    - Preliminary project approval (i.e., SDCP or Stormwater Concept Plan) prior to May 4, 2010.
    - Final SWM and erosion and sediment control plan approvals on or before May 4, 2013.
  2. These projects may proceed to construction based upon the County's SWM Ordinance in effect on or before May 4, 2009.
  3. In accordance with COMAR 26.17.02.05.C., SWM quantitative and qualitative control waivers may be granted for phased development projects if a system designed to meet the 2000 regulatory requirements and the County's ordinances for multiple phases was constructed by May 4, 2010. If ESD to the MEP cannot be met for future phases constructed after May 4, 2010, all reasonable efforts to incorporate ESD to the MEP in future phases must be demonstrated.



4. Sunset: All SWM approvals and permits designed without implementing ESD to the MEP shall expire on May 4, 2017, if the SWM system has not been constructed.

## 5.2 Concept Design Phase - Definition, Design Guidance, Planning Steps

### 5.2.1 ESD - Definition

Many storm water design strategies seek to replicate natural hydrology. They may be referred to as better site design, low impact development, green infrastructure, or sustainable site design. These strategies all espouse similar techniques. In each, a combination of planning techniques, alternative cover, and small-scale treatment practices is used to address impacts associated with development. For consistency, the SWM Act of 2007 adopts ESD as a more generic classification for use in Maryland.

County Code Sec. 32-171(a)(27) of the County Code defines ESD as

*"...using small-scale storm water management practices, nonstructural techniques, and better site planning to mimic natural hydrologic runoff characteristics and minimize the impact of land development on water resources."*

Under this definition, according to *Maryland Design Manual* Chapter 5, page 5-2, ESD includes:

- A. Optimizing conservation of natural features (e.g., drainage patterns, soil, and vegetation).
- B. Minimizing impervious surfaces (e.g., pavement, concrete channels, roofs).
- C. Slowing down runoff to maintain discharge timing and to increase infiltration and evapotranspiration.
- D. Using other nonstructural practices or innovative technologies approved by MDE and accepted by the County.

### 5.2.2 ESD - Design Guidance

The design process described in this section will provide guidance for implementing ESD planning strategies and practices into an SDCP. These techniques involve protecting natural resources, integrating erosion and sediment controls with SWM practices, minimizing site imperviousness, and using natural conveyance and ESD practices throughout the site. Applying these techniques early in the design process will ensure that all available resources have been considered, in order to protect streams and waterways from the

impact of land development activities. They are defined in County Code Sec. 32-179(a).

(a) *ESD Planning Techniques and Practices.*

(1) *The following planning techniques shall be applied to MEP according to the Maryland Design Manual to satisfy the applicable minimum control requirements established in 32-178 of this Division:*

(A) *Preserving and protecting natural resources;*

(B) *Conserving natural drainage patterns;*

(C) *Minimizing impervious area;*

(D) *Reducing runoff volume;*

(E) *Using ESD practices to maintain 100 percent of the annual average predevelopment groundwater recharge volume;*

(F) *Using green roofs, permeable pavement, reinforced turf, and other alternative surfaces;*

(G) *Limiting soil disturbance, mass grading, and compaction;*

(H) *Clustering development; and*

(I) *Any practices approved by the Administration.*

The design process will require the applicant to adhere to the following procedures to achieve ESD to the MEP:

- Develop a map that identifies natural resource areas and drainage patterns and devise strategies for protection and enhancement.
- Minimize total site imperviousness by implementing clustered development and other better site design techniques.
- Demonstrate that all reasonable opportunities for meeting storm water requirements using ESD have been exhausted by using natural areas and landscape features to manage runoff from impervious surfaces and that structural BMPs have been used only where absolutely necessary.
- Participate in the comprehensive review process for interim plans review and approval at the concept, site development, and final phases of project design.
- Integrate strategies for erosion and sediment control and SWM into a comprehensive development plan.

### 5.2.3 Concept Design Phase Planning Steps

The SDCP is the first step in project development for SWM purposes. The information to be developed and submitted for review is summarized for each of three phases. The following has been adopted with some modifications from Chapter 5 of the *Maryland Design Manual*.

The steps will include the following:

- A. Site and Resource Mapping (Natural Resources Inventory)
- B. Site Fingerprinting and Development Layout
- C. Locating ESD Practices

#### 5.2.3.1 Site and Resource Mapping

The resource mapping component will be used as a basis for all subsequent decisions during project design. The resource mapping is locally known in Prince George's County as a Natural Resources Inventory (NRI). The NRI is based on a requirement from County Code Sec. 32-182 and the *Environmental Technical Manual*. Based on the information developed for the NRI, the applicant shall present information for areas that could be protected and preserved on the SDCP. Additionally, options will be evaluated to enhance important hydrologic functions. Specific items from the NRI required to be on the SDCP are listed in the SDCP design review checklist, available from the DPIE website.

In addition, the mapping process that identified important natural resources will also identify areas that are highly susceptible to erosion. Identifying these important resource and high-risk locations and protecting them from disturbance or providing mitigating measures is part of the first step in the planning process. When steep slopes and highly erodible soils are found, measures may be taken to limit disturbance and minimize impacts as set forth in Subtitle 24. PGSCD maintains a list that identifies highly erodible soil map units for Prince George's County. The soils listing may be found on pages I-9 to I-13 in the PGSCD Reference Manual.

While it is not practicable to eliminate earth disturbing activities based exclusively on the soil erodibility or steep slope conditions, constraints are warranted when both steep slopes and highly erodible soils occupy the same area within the development footprint. The narrative for the

SDCP discusses the strategies to protect steep slopes and highly erodible soils, which include:

- Identify and map all highly erodible soils and steep slopes; and
- Protect areas with highly erodible soils on slopes equal to or greater than 15% from earth disturbing activities.

In addition to preserving sensitive areas during disturbances, the environmental benefits of other existing natural resources should be maximized by incorporating protection strategies into the overall goals of the project. Protecting these resources upfront in the planning process will allow their many functions to be utilized for infiltration, flow attenuation, groundwater recharge, flood storage, runoff reduction, nutrient cycling, air and water pollution reduction, habitat diversity, and thermal impact reduction.

When ESD practices are located later in the planning process, these protected areas may be further enhanced by using them to meet storm water requirements.

Natural resource protection and enhancement strategies include:

- A. Protect large tracts of contiguous open space, forested areas, and other important resources through conservation easements.
- B. Identify afforestation opportunities in open space areas and set aside land for natural regeneration.
- C. Identify important resources that may be expanded such as stream buffers and floodplain.
- D. Minimize disturbance to highly permeable soils.

#### **5.2.3.2 Site Fingerprinting and Development Layout**

After identifying sensitive resources, the next step in the planning process involves determining the approximate location of roads and lotting patterns that result in the location of buildings, roadways, parking lots, and other impervious areas. These site improvements should be placed at a sufficient distance to protect the conservation areas. Protecting sensitive resources may involve enhancing or expanding forested and stream buffers of adequate widths based on site characteristics. Through the Preliminary Plan of Subdivision and Type I Tree Conservation (TCP1) process the site layout is developed in accordance with Subtitles 24 and 27. The concurrence of the review of these development plans is crucial to avoid later revisions to the SDCP.

The County has identified minimum buffer widths as set forth in Subtitle 24 based on the location within the County of adjacent land slopes to streams, 100-year floodplain, wetlands, mature forests, vegetative cover, depth of the groundwater table (GWT), and the presence of spring, seeps, and other sensitive areas. The environmental buffers to be established are 60 feet in the ESA-1 (Formerly known as Developed Tier), 75 feet in the ESA-2 (Formerly known as Developing Tier), and 100 feet in the ESA-3 (Formerly known as Rural Tier), which are established in County Code Sec. 24-101 and implemented on a plan by County Code Sec. 24-130 and the Environmental Technical Manual. This information is available on PGAtlas. Buffers may be different or adjusted according to guidelines in PGSCD Reference Manual. See "Buffer Widths for Perennial and Intermittent Streams" on page I-6 in PGSCD Reference Manual, Section I.C. Lastly, buffers may also be adjusted if the watershed is identified by MDE as an impaired watershed or Tier 2 watershed. The names of the streams that are impaired, and their impairment and Tier 2 watersheds or streams, are summarized in PGSCD Reference Manual Section I.F and I.G.

The development footprint should take into consideration the natural drainage areas and how runoff will travel over and through the site. Sheet flow and existing drainage patterns should be maintained, and discharges from the site should occur at the natural swale locations wherever possible. New drainage patterns may result in concentrated flow leaving the site at an inappropriate or unstable location, as well as the possibility of creating erosion, sediment transport, and stream channel stability problems. The use of storm drains and engineered conveyance systems in large-lot subdivisions should be minimized by using vegetated swales and other natural systems so that forest buffers and overland flow characteristics remain intact. The planning process for on-site and off-site will also identify potential stable outfall locations.

Some of the strategies listed below may be used to establish nonstructural practices such as sheet flow to natural areas. These protection and enhancement tools can then double as important strategies for meeting on-site storm water requirements.

Strategies for site layout and connecting landscape features as identified by the MDE manual include:

- A. Plan the building footprint, lotting pattern, and layout to protect regulated environmental features and conservation areas.
- B. Evaluate opportunities to enhance/expand forested, wetland, and stream buffers.

- C. Grade the site so that runoff will flow from impervious areas directly to pervious areas or other natural conveyance systems.
- D. Maintain natural flow paths between the site and upstream and downstream systems.
- E. Maintain sheet flow and natural overland flow processes wherever feasible.
- F. Provide stable conveyance of runoff off-site.

Commercial and industrial developments offer other opportunities to reduce impervious cover. Because parking lots are the dominant land cover for most commercial and industrial projects, applicants can minimize the surface area dedicated to parking and use ESD practices in landscaped areas for storm water treatment or better site design techniques to reduce site imperviousness, protect environmentally sensitive areas, and provide more open space. More details and information may be found in *Better Site Design: A Handbook for Changing Development Rules in Your Community* (Center for Watershed Protection, 1998). The County will support any reasonable suggestions for reducing impervious areas.

The subdivision and zoning regulations mandate many of the criteria that, with a variance approved by the Planning Board, could be used to reduce impervious areas onsite. This should be discussed with M-NCPPC during its review of the Preliminary Plan of Subdivision.

### 5.2.3.3 Selecting/Locating ESD Practices

Many of the ESD practices discussed in Chapter 10 are tailored to fit in these smaller landscaped areas. When strategies for reducing imperviousness and protecting natural resources are combined with design options that distribute ESD practices throughout a site, the resulting plans will provide an effective means to address storm water requirements at the source. After the site footprint has been established, preliminary calculations for determining storm water requirements using ESD will be provided and potential management areas can be identified. The matrix in Appendix 5-2 can be used to select devices based on site or location constraints. The SDCP shall include the preliminary location of ESD practices. The design review checklist is available from the DPIE website.

Reducing the impervious area in residential, commercial, and industrial development enhances the space available for landscaped features (e.g., parking lot islands, medians, and plazas). For specific landscaping criteria, see the following document:

[Prince George's County Landscape Manual](#)

The landscaping of the islands may also be used to meet the TCP2 tree coverage requirements for a site. See tree canopy coverage guidelines within Subtitle 25 and the following document.

[Environmental Technical Manual](#)

**5.2.3.4 On-site and Off-site Outfall Considerations**

During the evaluation of storm drain, ESD, or SWM outfall locations, the County recommends that the design consultant perform a site visit to document existing conditions at the site prior to development. Site visits aid in identifying conditions that may impact the hydraulics or the placement of proposed systems. The items contained in Table 5-1 should be considered when performing a site inspection; however, the table is to be used as a guide (starting point) and not meant to be an all-inclusive list of items to be identified. Site conditions vary widely from site to site throughout the County.

**Table 5-1 Outfall Considerations**

<b>On-Site Considerations</b>	<b>Off-Site Considerations</b>
Underground utilities	Backwater conditions
Public (water, gas, sewer, etc...)	Downstream culvert
Private (septic systems, well heads, etc...)	Large river or pond
Steep or very flat slopes	Tidal influences
Existing and proposed sump points	Ditch or channel restrictions
Verify existing storm sewers	Large amounts of debris in channels
Soils (bedrock vs. sand/clay)	Future development (Use Zoning as a guide)

**5.2.4 Minimum Stormwater Control Requirements and Sizing**

The components of SWM and storm drainage systems are classified into four major categories:

- ESD Control (Treatment of Target Rainfall Amount using MDE Table 5.3 for new development and 1 inch for redevelopment). Use 2.7 inches for the maximum allowable volume to be treated at any device.
- Quantity Control (attenuation of 10-year storm increases)
- Flood Control (attenuation of 100-year storm increases)

- Conveyance (Storm Drain System)

#### 5.2.4.1 ESD Sizing

All SDCPs shall include a variety of ESD techniques to achieve the overall ESD volume requirements, in accordance with sizing criteria defined in the *Maryland Design Manual*. Calculations shall include the ESD target volume (“required volume”) to each point of interest. A point of interest is considered a sub-drainage area on the site. The site’s natural and manmade drainage divides will be used to demarcate the various sub-watersheds.

ESD target volume is to be calculated as:

$$ESD_v = P_E \times R_v \times A/12 \quad (\text{Maryland Design Manual Chapter 5})$$

The SDCP shall also provide sizing calculations for ESD devices by providing a BMP Summary Table. See Appendix 5-3 for a sample table.

##### 5.2.4.1.1 ESD -Target Rainfall

The target rainfall  $P_E$  amounts for sizing ESD practices to mimic woods in good condition for each respective Hydrologic Soil Group are located in *Maryland Design Manual* Chapter 5, Table 5.3. These rainfall amounts are also used to determine the reduced runoff curve numbers for calculating additional storm water requirements if the targeted  $P_E$  cannot be met.

#### 5.2.4.2 10-Year Storm Attenuation Sizing

Attenuation may be required if downstream channels, infrastructure, structures, and/or conveyance system have inadequate capacity to handle the 10-year storm. In these instances, a BMP must be proposed to attenuate the increase in the 10-year storm. For the 10-year storm event, the post-development peak rate of discharge shall be equal to or less than the pre-development peak rate of discharge. The pre-development 10-year peak flow shall be based on woods in good hydrologic condition for existing wooded areas and meadow in good hydrologic condition for existing pervious areas including agriculture and impervious areas. The post-development 10-year peak flow shall be based on the project site as ultimate development.

#### 5.2.4.3 100-Year Storm Attenuation Sizing

Attenuation may be necessary to control flooding downstream. This is generally required when existing homes or buildings downstream of the site are affected by the 100-year floodplain and/or known flooding



problems exist. In these instances, a BMP must be proposed to attenuate the increase in the 100-year storm. For the 100-year storm event, the post-development peak rate of discharge shall be equal to or less than the pre-development peak rate of discharge. The pre-development 100-year peak flow shall be based on woods in good hydrologic condition for existing wooded areas and meadow in good hydrologic condition for existing pervious areas including agriculture and impervious areas. The post-development 100-year peak flow shall be based on the project site as ultimate development.

Some alternate methods that may be considered may include:

- Acquire known flooded residential or commercial properties.
- Evaluate impacts by analyzing peak flow changes by hydrograph timing to determine the magnitude of change.
- Offsite flood mitigation measures to protect a structure.

#### 5.2.4.4 Conveyance Systems

Conveyance systems consist of closed (inlets and manholes); open (swales, ditches, or streams); or a combination of the two.

##### 5.2.4.4.1 Open Drainage Systems

Open drainage in a natural undisturbed watercourse is strongly encouraged provided no further improvements to the watercourse will be required after ultimate watershed development and the open system is compatible with the proposed land use of the property, or with future development of adjacent properties. The conversion of natural stream channels to engineered channels such as gabion, concrete, riprap, or earthen is strongly discouraged. If conversion is proposed, multiple permits from local, State, and Federal permitting agencies will be required.

Channel conversion does not contribute to using the natural stream features to reduce flows and provide other water quality benefits. Therefore, they will only be considered under extreme conditions where the preservation/restoration of the natural channel is not feasible.

For existing engineered channels, repair and replacement may be the only acceptable alternative. The conversion of the engineered channel to restore the natural characteristics will be encouraged where practical. Careful consideration of a modified floodplain

limit must be evaluated for potential impact to adjacent properties. With proper planning, natural channels can be used to safely carry runoff, preserve water quality, protect wetlands and stream habitat, and improve the aesthetic value of the project.

- A. Floodplain/Lot Separation - A 100-year floodplain easement or surface drainage easement (drainage areas less than 50 acres) is required for open systems not in public space. In general, residential lots (less than 2 acres) must be separated from the floodplain by a distance sufficient to accommodate future stream channel changes and possible floodplain elevation increases. A separation distance of 50 feet is typically required between the floodplain and residential lot building restriction line. In no case may residential structures be closer than 25 feet from the floodplain limit (County Code Sections 24-129(a)(5) and 32-205(f)).
- B. Stability - Some erosion in natural streams can be expected; however, unless the channel is reasonably stable and is expected to remain stable after ultimate development of the watershed, or is a sufficient distance from lots/improvements, stabilization measures will be required. The importance of stability increases as the proximity of lot improvements to the stream decreases. In all cases, sufficient floodplain easements and/or erosion protection must be provided so that the channel will not meander out of the easements within the near future. In general, open natural channels are not permissible on residential lots smaller than 2 acres. Instead, they should be located on open space parcels.
- C. Water Quality and Habitat Protection - Open drainage conveyance systems increase the opportunity for infiltration and interception, retention, and detention of storm water. The use of open drainage conveyance systems can reduce the amount of storm drain infrastructure, and increase the Tc. In general, an open drainage conveyance system must be designed to carry the 10-year storm with a safe overflow of the 100-year storm. Open drainage conveyance systems will require further evaluation and approval from DPIE when residential lot width average at the street is less than 100 feet.

#### 5.2.4.4.2 Closed Systems

Except for desirable natural watercourses through open space areas and large residential lots, storm water surface flows across developed residential properties are limited to 3 cubic feet per second (cfs) for a 10-year design storm, before discharge to a natural channel or pickup by a storm drain inlet. For surface flow on lots or open space parcels, an enclosed storm drain system shall be provided. In accordance with County Code Sec. 32-162 (a) (6),

- (6) *All drainage terraces, interceptor and diversion berms, swales and ditches shall be designed and constructed in accordance with standards contained elsewhere herein and when required, shall be piped or paved or otherwise improved. In order for drainage to discharge into natural watercourses such natural ground shall be protected from erosion by an adequate amount of riprap or by other measures. Flows exceeding three (3) cubic feet per second will not be permitted in open facilities such as swales and ditches, but shall be conveyed in enclosed storm drain systems. Concentrated flow in driveways, parking lots and access lanes shall not exceed one-half (1/2) the width of paving, or ten (10) feet, whichever is less.*

For projects where underlying Marlboro Clay outcrops or other clays with high shrink/swell exist, enclosed storm drain systems will be required when 100-year concentrated flows are greater than 2 cfs.

- A. Pipe systems must be designed to accommodate the amount of flow that would be generated from ultimate development conditions for a 10-year storm, or a 100-year storm for a site with Marlboro Clay. Attenuation of flows by using the ESD or other SWM devices may be used to reduce storm flows for SWM only. The pipe systems must be designed deep enough to allow for future upstream extensions.
- B. Entrance and outfall structures not located in a floodplain are to be located off residential lots and beyond project limits. This requires the acquisition of storm drain easements from adjacent property owners. Early consideration of easement requirements is advisable. Easements for discharge locations may be required when:
- The point of discharge has been converted from sheet flow to concentrated flow, or

- The point of discharge has been altered in location, or
  - There is an increase in the 100-year design storm peak flow.
- C. For those situations in which an easement cannot be obtained, satisfactory evidence must be provided proving that a sincere effort to obtain the easement has been made and that the applicant is willing to meet all reasonable demands of the intended grantor. This could include certified letters for property owners not willing to discuss the issue. If the applicant cannot obtain the downstream easement, the release rate must be controlled to the pre-developed 100-year storm. In the following cases, an entrance or outfall structure and riprap may be located at the edge of the project site:
1. On residential lots if the location is sufficiently distant from the house; allows fencing of the lot; does not result in a ditch greater than 3 feet deep; will not otherwise adversely affect the appearance and use of the lot; and will not result in damage to the up- or down-grade property;
  2. On non-residential properties if the end of the riprap is located a minimum 5 feet away from the property line; and will not result in damage to the up-or down-grade property. In these instances, the peak flow onto the downstream property(ies) may not be increased for the 100-year storm
- D. 100-Year Overflow Path/Lot Relationships - An overflow path through the development must be provided to convey the 100-year flows without causing structural flooding or property damage.
- E. For buildings located upstream of a culvert, the lowest entry elevation shall be a minimum of 1 foot above the road overflow elevation.
- F. For buildings located adjacent to low points in a yard, street, or parking lots, the grade adjacent to a building shall be a minimum of 1 foot higher than the overflow elevation. If the overflow path is near a garage, the garage

elevation at the driveway shall be 6 inches above the overflow elevation.

- G. The maximum permissible ponding depth if a structure is clogged shall be 2 feet. This applies to open space locations as well as public roads.

### 5.2.5 Public / Private Maintenance

All storm drain and storm water management facilities serving single family and townhouse residential developments shall be publicly maintained, with the exception of environmental site design facilities. Environmental site design facilities are defined in chapter 10 of this manual.

Environmental site design facilities shall be maintained as follows:

- ESD facilities located outside the public road r/w shall be private and maintained by the property owner, homeowners association, condominium association or business park association.
- ESD facilities located in the county public road r/w for primary and secondary residential streets and industrial streets shall be public. Functional maintenance of public ESD facilities shall be performed by Prince Georges County. Aesthetic maintenance of public ESD facilities shall be performed by the abutting property owner.
- ESD facilities located in the county public road r/w for collector and arterial roadways shall be public and maintained by the county.
- ESD facilities in the public road r/w shall only treat runoff from the public road r/w. All other runoff shall be treated by facilities located outside the public road r/w.

All storm drain and storm water management facilities serving industrial, commercial, multi-family residential and mixed use developments shall be privately maintained, except as otherwise determined by DPIE. Facilities owned or operated by public agencies, such as the Prince George's County Public Schools, Maryland National Capital Park and Planning Commission (M-NCPPC), Prince George's County Housing Authority, Prince Georges County Office of Central Services, etc. shall be maintained by these respective county agencies.

Storm drain systems (enclosed storm drain, open channels, and culverts) conveying offsite storm water runoff through a site shall be publicly maintained. Storm drain systems within the public road r/w shall be publicly maintained.

Functional maintenance of county public storm drain and storm water management facilities shall be performed by Prince Georges County. Aesthetic maintenance of public storm water management facilities shall be performed by

the property owner, homeowners association, condominium association or business park association.

Private storm drain and storm water management facilities shall be solely and perpetually maintained by the property owner, homeowners association, condominium association or business park association.

The landowner shall execute and record a Declaration of Covenant for the maintenance of public and private storm and surface water management facilities and systems for each lot and parcel within the permit limit. This Declaration of Covenant shall be recorded prior to issuance of the permit or in some instances prior to plan approval.

**Definitions:**

**Functional maintenance** shall include mowing of grass once a year, removal of debris or sediment build up that results in clogging or loss of function, life cycle maintenance including replacement of pipes, structures, clogged filters, damaged or inoperable valves, stairs, trash racks and other appurtenances, and repair to the structural integrity of earthen embankments, outfalls and access roads.

**Aesthetic maintenance** shall include mowing, weeding, mulching, raking, removal of debris, replacement of landscaping, restoration and repair of existing features including grass, lawn, walkways, trails, fencing, signs, walls and repair due to erosion.

**5.2.6 Existing Off-site Erosion/Flooding/Conveyance Problems**

Development normally increases downstream peak flows and total flow quantities by increasing the impervious area, reducing the travel times within the drainage systems, and reducing the amount of pervious area. The County may require additional controls or measures in accordance with County Code Sec. 32-178(a).

- (a) *The minimum control requirements established in this Section and the Maryland Design Manual are as follows:*
  - (1) *Planning techniques, nonstructural practices, and design methods specified in the Maryland Design Manual shall be used to implement ESD to the MEP. The use of ESD planning techniques and treatment practices must be exhausted before any structural BMP is implemented. Stormwater management design plans for development projects subject to this Division shall be designed using ESD sizing criteria, recharge volume, water quality volume, and channel protection storage volume criteria according to the Maryland Design Manual. The MEP standard is met when channel stability is maintained, 100% predevelopment groundwater recharge is replicated, non-point*

*source pollution is minimized, and structural storm water management practices are used only if determined to be absolutely necessary.*

- (2) *Attenuation of the 2-year, 10-year frequency storm event for downstream erosion exists and/or attenuation of the 100-year frequency storm event for downstream flooding exist are required according to the Maryland Design Manual and all subsequent revisions when the Department determines that additional storm water management is necessary because the receiving channel and/or conveyance system are determined inadequate.*
  - (3) *The Department has the authority to require more than the minimum control requirements specified in this Division if hydrologic or topographic conditions warrant or if flooding, stream channel erosion, or water quality problems exist downstream from a proposed project.*
- (b) *Alternative minimum control requirements may be submitted for approval to the Administration. A demonstration that alternative requirements will implement ESD to the MEP and control flood damages, accelerated stream erosion, water quality, and sedimentation will be required by the Department. Comprehensive watershed studies also may be required.*

#### **5.2.6.1 Extent of Downstream Hydraulic Analysis:**

Off-site areas that are, or could be, adversely impacted by storm water flows for the 10- ( $Q_P$ ) or 100-year ( $Q_F$ ) storm events shall be evaluated and considered for improvement, in addition to, or instead of, on-site storm water management controls. The extent of the analysis depends on the development's potential for adverse impacts.

Factors that affect the magnitude of impact are the size and type of development, the size and type of drainage system, and the use of the land through which the system passes downstream. Generally, the downstream analysis should extend to a point at which the flow from the development is less than 10% of the total flow in the stream. In those situations where there is an obvious risk of adverse downgrade impacts on other properties, an analysis will be required regardless of the percentage of flow increase.

This evaluation should begin during the SDCP review stage. Areas that are currently experiencing erosion, flooding, or water quality runoff problems are typical candidates for such improvements.

Where off-site SWM improvements would be more beneficial than on-site facilities, the applicant may be required to provide off-site improvements, at the discretion of DPIE. Property owners required to provide off-site improvements may be entitled to a reduction in the SWM fee and/or the level of on-site SWM control otherwise required for their project. The cost of the off-site improvements shall be based on an amount that is determined to be comparable to the cost of on-site controls and/or SWM fees for the site to be developed. This amount is determined by DPIE, based on cost estimates developed by the applicant's design consultant, using the DPIE unit cost data.

Quantity control of the 10-year storm may be required at the discretion of DPIE if the downstream analysis indicates that the existing downstream infrastructure and/or conveyance system has an inadequate capacity to safely handle a 10-year storm.

Quantity control of the 100-year storm may be required at the discretion of DPIE if the downstream analysis indicates that:

- A. Previous flooding has occurred; or
- B. Houses would be within 25 feet of the 100-year floodplain; or
- C. Buildings other than houses would be within the 100-year floodplain.

If the downstream analysis indicates that existing infrastructure is impacted, the applicant should contact DPIE for input prior to obtaining concept approval.

The applicant may request DPIE to consider off-site mitigation for flood control, rather than providing on-site controls. If it can be demonstrated that the proposed off-site improvements are more beneficial to the affected community, then DPIE will consider the request. However, the primary intent of the off-site mitigation option is to provide an alternative, in cases where on-site SWM construction is infeasible and no adverse effects downstream would result from a waiver of on-site controls.

#### **5.2.6.2 Road Crossing Stream Site Inventory**

DPIE recommends performing the stream site inventory at the same time the NRI is completed or as early in the design process as feasible. Because lot layout and project yield are contingent on the location of the streets, the stream inventory should be completed prior to submission of the Preliminary Plan of Subdivision review. While stream crossings are often dictated by the geometric



layout of the roadway, the design consultant should make efforts to find the best possible site for the stream crossing. Assessment and mapping of the following natural resources are necessary in order to assist in properly locating a crossing:

- Existing stream channel geometry (cross sectional and longitudinal);
- Width, depth, and velocity of normal flow (base flow);
- Width, depth, and velocity of the bank full storm event;
- Locations of wetlands and wetland type (i.e., forested shrub/scrub, etc.);
- Location of steep slopes;
- Location of high-quality forest;
- Floodplain characteristics (geometry, slope, soils, etc.);
- Stream bed and stream bank composition; and
- Narrowest point of stream.

A site visit is necessary to gather baseline information for these factors. At a minimum, the stream walk should include conducting a photographic inventory and completing habitat and biological assessments while confirming soils, wetlands, steep slopes, and other factors. See Appendix 5- 4 for a sample field inventory form.

#### **5.2.6.3 Receiving Stream Erosion Analysis:**

Just as flooding of downstream properties is a concern, stream erosion in the County is another issue. The stream shall be walked and the report shall include photos of the stream at the approximate outfall location, the upstream end of the property, the downstream end of the property, and any severely eroded areas. The photos shall be located and identified on the SDCP. The report shall include a brief description of stream geomorphology and any problems of note. For extreme erosion issues, proposed mitigation shall be discussed. The information will be evaluated by DPIE and any requirements for stream improvements will be addressed during the SDP phase or prior to the Final Plan phase if there is no SDP.

#### **5.2.7 Redevelopment**

Since redevelopment projects are generally located in highly urbanized areas, which may have unique stream and conveyance system problems, the applicant

is encouraged to meet with DPIE and M-NCPPC prior to SDCP submittal. In order to encourage smart growth and maximize benefits to the receiving waters or conveyance system, the Director may grant a variance from the requirements below in favor of more site-specific requirements.

### 5.2.7.1 Redevelopment Design Criteria

For ESDv requirements for redevelopment, see County Code Sec. 32-175..

*County Code 32-175(b) All redevelopment designs shall:*

1. *Reduce impervious area within the limit of disturbance (LOD) by at least 50 percent according to the Maryland Design Manual;*
2. *Implement Environmental Site Design (ESD) to the Maximum Extent Practical (MEP) to provide water quality treatment for at least 50 percent of the existing impervious area within the LOD; or*
3. *Use a combination of subsections (b) (1) and (2) for at least 50 percent of the existing site impervious area within the LOD; and*
4. *Infiltrate into the ground 100 percent of the annual average predevelopment groundwater recharge volume if soil's infiltration is 1.02 inches per hour or greater.*

*County Code 32-175(c). All redevelopment designs approved after May 4, 2016, shall:*

1. *Reduce impervious area within the LOD by 75 percent in accordance with the Maryland Design Manual;*
2. *Implement ESD to the MEP to provide water quality treatment for 75 percent of the existing impervious area within the LOD; or*
3. *Use a combination of subsections (c) (1) and (2) to meet 75 percent of existing site impervious area within the LOD; and*
4. *Infiltrate into the ground 100 percent of the annual average predevelopment groundwater recharge volume if soil's infiltration is 1.02 inches per hour or greater.*

*County Code 32-175(d) All redevelopment designs approved after May 4, 2019, shall:*

1. *Reduce impervious area within the LOD by 100 percent in accordance with the Maryland Design Manual;*

2. *Implement ESD to the MEP to provide water quality treatment for 100 percent of the existing impervious area within the LOD; or*
3. *Use a combination of subsection (d)(1) and (2) to meet 100 percent of existing site impervious area within the LOD.*

*County Code 32-175(k) Stormwater Management shall be addressed for the portion of the site within the limit of disturbance according to the new development requirements in the Maryland Design Manual for any net increase in impervious area.*

*County Code 32-175(l) If the Department determines that existing flooding and/or erosion exist downstream of the proposed development, the Department:*

- (1) should require the applicant to manage the channel protection volume using ESD to the MEP; and*
- (2) has authority to require the applicant to attenuate the 2-year and 10-year storm runoff for downstream erosion for residual volume not addressed by ESD; and*
- (3) has authority to require the applicant to attenuate the 100-year frequency storm event for downstream flooding in accordance with the Maryland Design Manual.*

### **5.2.7.2 Development and Redevelopment of Sites with Existing Controls**

Section 5.2.6.1 identifies the process to follow if no SWM has been previously provided for the site. However, because the requirement to provide quality or quantity control has existed since the early 1980s, it is possible that a site being developed or redeveloped will have some element of onsite SWM control constructed. The intent is to ensure that the ultimate water quality for a site will comply with the criteria established by the MS4 permit, any applicable TMDLs, and other State or Federal mandated programs. In general, if the site has constructed water quality facilities, then

- If a site only has water quality facilities that currently treat the first inch of rainfall, no additional treatment is required. However, new impervious area is to be treated using ESD to the MEP.
- If the site existing water quality facilities do not provide the first inch of runoff treatment, then the applicant must provide additional treatment to meet the first inch of runoff requirement.

- If feasible and beneficial, constructed SWM facilities may be modified to provide either quality or quantity control, if it is determined the modification will be beneficial to the County's Phase II Watershed Implementation Plan and Phase I MS4 permit requirements.
- If the site has an existing swm facility built *based upon* the MDE 2000 Stormwater Management requirements, no additional treatment is required.
- If the site has existing facilities built *prior* to the MDE 2000 Stormwater Management requirements, ESD to the MEP is required,
- If the site has existing stormwater management facilities built *based upon* the MDE 2007 Stormwater Management requirements, no SWM is required,

If the proposed redevelopment exceeds the County requirements specified in County Code Sec. 32-175(b), additional consideration may be given based on County Code Sec. 32-175 (e).

- (e) *To offset the cost and design impacts of achieving the requirements of subsection (b) and (c) of this section, redevelopment designs that exceed the County requirements by twenty-five (25) percent and that are approved after May 4, 2011, are eligible to receive, subject to Subtitle 27 of the County Code:*
1. *Increased density through the public benefit credits, density increment factors or additional floor area ratios (FARs);*
  2. *Reduction in the number of spaces and design of on-site parking to accommodate ESD techniques;*
  3. *Priority consideration during the County's development review and permitting processes;*
  4. *Eligibility for residential revitalization tax credit under Subtitle 10, Subdivision 5B and Section 27-445.10 of the County Code without Council approval;*

SWM controls are not required for existing road pavement that is to be milled and overlaid; this work is considered to be maintenance, for which SWM controls are not required. If, however, the road is reconstructed, then the reconstructed impervious area shall be treated as

redevelopment, if the project is eligible for redevelopment (based on the 40% threshold), or otherwise treated as new development. SWM controls are required for any road widening required for the development.

### 5.2.7.3 Redevelopment Policy

In accordance with NPDES requirements for Urban Retrofit, the County will designate a watershed each year for which water quality retrofit measures must be provided. The goal is to provide water quality for 20% of the impervious area within the watershed. In order to meet this goal, the County may offer incentives to redevelopment projects to provide more than the minimum requirements outlined above.

County Code Sec. 32-175 requires SWM plans to be prepared for all redevelopment, unless otherwise specified by watershed management plans developed according to County Code Sec. 32-172. SWM measures must be consistent with the *Maryland Design Manual*.

Additional guidance may be found from MDE at the following link.

[ESD Redevelopment Examples](#)

## 5.3 SDCP Preparation

The intent of the concept planning process is to determine the storm water elements that are required for the proposed development. Sufficient engineering analyses must be provided to demonstrate that the concept is valid. The concept planning process also serves to determine roadway improvements, safety concerns, geotechnical conditions, flooding concerns, and other site-related matters.

### 5.3.1 Submittal Requirements

The applicant shall submit an SDCP to DPIE that provides sufficient information for an initial assessment of the proposed project. Plans submitted for SDCP approval shall include the items on the submittal checklist and they include but are not limited to:

- Completed Site Development Concept Plan Submittal Checklist
- Site Development Concept Plan Application
- Site Development Concept Plan Design Review Checklist
- Site Development Concept Design Plan
- Application Fee

- Drainage Area Map and Proposed BMP Summary Table
- Site Development Concept Plan Report (Narrative)
- Soils Report (if applicable)
- Existing 100-Year Floodplain Delineation
- Sight Distance Analysis (for new roads/ driveway entrance connections to existing roadways)
- Stormwater Pollution Prevention Plan, if applicable
- Natural Resources Inventory Plan
- Affidavit

### 5.3.2 Site Development Concept Plan:

The plan should be prepared at a scale no smaller than 1" = 50'. It is preferred that all plans including the Preliminary Plan of Subdivision, TCP1, and NRI are prepared at the same scale. The SDCP shall include existing and proposed topography, roads, homes, other buildings and structures, and other site improvements. Please note that the lotting pattern, road system, and development area of the site may be modified through the site development review process. Coordination with M-NCPPC is recommended to avoid conflicts in the plan's review and approval process. The plan should delineate existing environmental features such as wetlands, floodplains, and stream buffers. The plan should include existing and proposed storm drain systems and existing and proposed storm water management BMPs. The entire content of the plan shall be prepared in accordance with the design review checklist on the County website.

The SDCP may be prepared using the matrix in Appendix 5-2 to identify acceptable practices. The matrix identifies the different types of ESD practices that may be used based on site conditions such as soils, zoning, ground water, land use, maintenance responsibilities, or storm water hotspots. The Department encourages the practices that will be easiest to maintain by the ultimate user of the site.

The SDCP should be submitted to DPIE and include the information discussed above, along with a narrative to support the design. The narrative should describe how important natural areas will be preserved and protected, and show how ESD may be achieved for meeting on-site storm water requirements. DPIE may require additional information at this phase; however, at a minimum an SDCP should include the following elements:

- A. A map of all site resources shown in the checklist;
- B. Field verification from the design consultant of the natural resource map;
- C. Proposed limits of clearing and grading;
- D. Location of proposed impervious areas (buildings, roadways, parking, and sidewalks);
- E. Location of existing and proposed utilities;
- F. Preliminary estimates of storm water requirements;
- G. Preliminary location of ESD practices;
- H. Stable conveyance of storm water at potential outfall locations; and
- I. A narrative that supports the concept and describes how the design will achieve:
  1. Natural resource protection and enhancement;
  2. Maintenance of natural flow patterns;
  3. Reduction of impervious areas through better site design, alternative surfaces, and nonstructural practices;
  4. Integration of erosion and sediment controls into the storm water strategy; and
  5. Implementation of ESD planning techniques and practices to the MEP.

### **5.3.3 Site Development Concept Plan - Report Requirements**

The general format of a SDCP report shall include the following sections:

- Introduction
- Site Development Concept Plan Application Form
- Site Information
- Measures Taken to Meet ESD to the MEP

- Sediment Control Narrative
- Dam Breach (Optional)
- Stormwater Hotspots (if applicable)
- Stormwater Management Calculations and Summary Tables
- Geotechnical Evaluations
- Drainage Area Maps - 11" x 17" Reduction
- Site Development Concept Plan

#### **5.3.3.1 Introduction:**

The report will describe the site and the proposed measures to be implemented. In addition, it will also include justification if the minimum requirements identified above have not been met. If a surface SWM pond is proposed, a preliminary dam breach analysis may be required with the report to verify that downstream properties will not be adversely affected by a potential dam breach.

#### **5.3.3.2 Site Development Concept Plan Application Form:**

The SDCP application, which is located on the DPIE website, is an important document for the County and other reviewing agencies, as it contains information about the site and surrounding areas. The SDCP application information is used for tracking, description, recognizing locations of national or historic resources, and identifying other information for development. Description of the information to be provided is located in Section 5.7.

Although websites are provided for a number of categories, M-NCPPC is constantly updating PGAtlas with data that will help in the planning process because it contains a significant amount of data that may be used in the planning process. The website is located at:

[PGAtlas](#)

#### **5.3.3.3 Site Information:**

On the application form, the Site Information Section includes information about the site, such as location, zoning, project area, and existing conditions. Describing the site is important for the County to



understand if any storm water controls are present for the site. This includes drainage area to a facility, type of controls provided, and the type of features being used to provide quality and quantity control. Information noted on the application form may be explained in greater detail to better define the site data for the DPIE reviewer.

#### **5.3.3.4 Measures taken to meet ESD to the MEP:**

A well-reasoned narrative of how ESD to the MEP shall be met is required. If ESD to the MEP is not met for nonstructural devices, include a discussion of why each type of ESD device could not be used to the full extent if it is applicable to the type of device based on the matrix. For example, a discussion on why a green roof is not applicable to a single family dwelling is not required, whereas for a commercial facility it may be appropriate. Because development could consist of a single family lot up to a high-rise facility encompassing the entire lot area, the type of devices to be used requires different approaches to meet the ESD requirements.

One of the primary arguments that is used to not meet ESD to the MEP is that it costs too much to implement. This by itself is not a sufficient reason to allow elimination of the nonstructural measures. The applicant will need to prove this by demonstrating that nonstructural measures are impractical, when defining actual cost comparisons and/or project density reductions. It is incumbent upon the applicant to provide the background data necessary to justify the reduction or elimination of nonstructural approach.

#### **5.3.3.5 Sediment Control Narrative**

Include in the report a narrative defining how sediment control will be provided on a site. Items to consider include, but are not limited to: size of the disturbed area, types of soils, disturbance on steep slopes, and wetlands or water impacts. Some sites will require very simple sediment controls such as surrounding the site with an earth dike and draining the water to a sediment trap. Larger projects should include an explanation of how and where the project would be broken into phases of a maximum of 20 acres of disturbed area, and if trapping devices will be used for multiple phases. The narrative could discuss breaking the project into multiple phases, or how a stream crossing would be achieved, especially for streams or larger drainage areas. Other factors to consider include effects on the location of the limits of disturbance, and ultimately, the amount and location of area to be left undisturbed, particularly forested areas.

#### **5.3.3.6 Dam Breach (Optional)**

The County has a policy of not accepting high hazard facilities for development projects. To ensure that an SDCP is feasible, the design consultant should evaluate the potential dam breach impacts early in the project planning process. The dam breach analysis will be reviewed by PGSCD at the SDP phase.

#### 5.3.3.7 Stormwater Hotspots:

The following information was obtained from *Maryland Design Manual* Section 2.8 and reiterated here.

A storm water hotspot is defined as a land use or activity that generates higher concentrations of hydrocarbons, trace metals or toxins, or other pollutants than are generally found in typical storm water runoff based on monitoring studies. Special attention must be paid to these sites in order to develop management strategies that address the unique problems of these sites. First and foremost, untreated storm water runoff from hotspots cannot be allowed to infiltrate into groundwater where it may contaminate water supplies.

For example, infiltration techniques may not be permitted where groundwater contamination could occur. Therefore, the Recharge Volume (Rev) requirement is NOT applied to development sites that fit into the hotspot category (the entire  $WQ_v$  must still be treated). In addition, a greater level of storm water treatment is needed at hotspot sites to prevent pollutant wash-off after construction. This typically involves preparing and implementing a storm water pollution prevention plan that involves a series of operational practices at the site that reduces the generation of pollutants by preventing contact with rainfall. The report must include information on how ESD will be met for the hotspot. For additional information refer to Section 2.8, Table 2.6, and Appendix D.6 of the *Maryland Design Manual*.

Under EPA's NPDES storm water program, some industrial sites are required to prepare and implement a Stormwater Pollution Prevention Plan (SWPPP). A list of industrial categories that are subject to the pollution prevention requirement can be found in *Maryland Design Manual* Appendix D.6. In addition, Maryland's requirements for preparing and implementing a storm water pollution prevention plan are also described in the general discharge permit provided in the same appendix. The storm water pollution prevention plan requirement applies to both existing and new industrial sites.

The following land uses and activities are deemed storm water hotspots:

- A. Vehicle salvage yards and recycling facilities \*

- 
- B. Vehicle service and maintenance facilities
  - C. Vehicle and equipment cleaning facilities \*
  - D. Fleet storage areas (bus, truck, etc.) \*
  - E. Some industrial sites for Standard Industrial Classification codes outlined in *Maryland Design Manual Appendix D.6*
  - F. Marinas \*
  - G. Outdoor liquid container storage
  - H. Outdoor loading/unloading facilities
  - I. Public works storage areas
  - J. Facilities that generate or store hazardous materials \*
  - K. Commercial container nursery
  - L. Other uses as designated by DPIE or MDE.

\* Stormwater pollution prevention plan implementation is required for these land uses or activities under the EPA NPDES storm water program (see *Maryland Design Manual Appendix D.6*).

The following land uses and activities are not normally considered hotspots:

- Residential streets and rural highways
- Residential development
- Institutional development
- Commercial and office developments
- Non-industrial rooftop
- Pervious areas, except golf courses and nurseries [which may need an Integrated Pest Management Plan].

While large highways (with an average daily traffic volume of greater than 30,000 vehicles) and retail gasoline outlet facilities are not designated

as storm water hotspots, it is important to ensure that highway and retail gasoline outlet SWM plans adequately protect groundwater.

#### **5.3.3.8 Geotechnical Evaluations:**

##### **Soil Borings**

Steep slopes, Marlboro Clay, highly erodible soils, high GWTs, and infiltratable soils, are just some of the soil factors to be considered when developing a site. The first step is to evaluate the soils using the latest version of the soil survey by NRCS. In addition, extensive Marlboro Clay deposits located throughout the County have been mapped and may be obtained from PGAtlas. However, not all Marlboro Clay sites are completely mapped, and the soils investigation is necessary to determine whether Marlboro Clays exist horizontally and vertically on the project site. See Appendix 8-1 for the geotechnical procedures required to establish location and elevations of Marlboro Clay.

In addition to the soil boring requirements for Marlboro Clay, soil borings to establish groundwater and infiltration characteristics for ESD devices are required. Sufficient soil borings shall be provided to document the groundwater condition for the site to establish ESD types and locations. If infiltration type devices such as permeable pavement, enhanced filters, and dry wells are proposed, provide some soil borings and infiltration testing. Ultimately, a soil boring will be required at or immediately adjacent to an infiltration device. See Table 10-1 for additional information. Therefore, if feasible, this information should be provided sooner rather than later.

The soil boring infiltration report shall include the groundwater elevation and shall be in accordance with the methodology in Appendix 9-12 and 10-1.

Regardless of the specific soil issues, a discussion of how they will be handled during design and construction is required for both temporary and permanent conditions. Methods could include avoidance, additional stabilization, establishing flatter slopes, and other methods that might be required to mitigate the soils' potential impacts on a project's development during construction and its long-term effects. Additional information for treatment procedures can also be found in the latest version of the Soil Erosion and Sediment Control - Pond Safety Reference Manual, by the PGSCD. Soil reports may also be required through the Preliminary Plan of Subdivision process when the lotting pattern and site development area may be limited, and appropriate safety factor lines must be established and delineated on the final plat approval.

#### **5.3.3.9 SWM Calculations and BMP Summary Table**

Detailed calculations and a BMP summary table prior to the start of the computations are required to document the conceptual project goals based on the discussion from Section 5.3.3.4.

#### 5.3.3.10 Drainage Area Maps

Drainage area maps for existing and proposed conditions shall be provided. Full size plan sheet maps reduced to 11" x 17" should be provided in the report.

#### 5.3.3.11 Appendices

The Appendices shall contain the computations for the SDCP report. This includes storm water hotspot information as well as preliminary computations to document size and number of water quality and quantity facilities. It is suggested that each appendix be numbered separately as opposed to numerically for all pages in the report. This will allow easier insertion without having to renumber all the pages in the report.

### 5.4 Public Maintenance versus Private Maintenance

Section 5.2.5 of this manual defines standards for public versus private storm drain and SWM systems. Prior to plan approval of private storm drain and public/private SWM facilities, the Owner will be required to sign and record a Declaration of Covenant. A sample Declaration of Covenant is included in Appendix 11-7.

Owners of both publicly and privately maintained facilities will be required to maintain those facilities, and will be subject to periodic inspection and subsequent enforcement by the DOE according to County Code Sec. 32-196. This requires an inspection after the first year of acceptance of completion (i.e., after release of permit by County) and at least once every 3 years thereafter.

### 5.5 Public Notification

The County Code requires Public Notification for all SDCPs. The following excerpt from the County Code defines the requirements of this public notification:

*Section 32-182(g) Notification.*

- (1) *The applicant shall send, within seven (7) days of filing of a storm water concept plan under this Section, by first class mail an informational mailing to all adjoining property owners, including owners whose properties lie directly across a street, alley, or stream, to every municipality located within one (1) mile of the applicant's property and to all civic associations registered with the Maryland National Capital Park and Planning Commission pursuant to Sec. 27-125.01 of the County Code for the area which includes the property.*

- (2) *The applicant shall file an affidavit of mailing with the Department prior to approval of the storm water concept plan. The affidavit shall give the names and addresses of all persons sent informational mailings and the dates when they were sent.*
- (3) *Before a storm water concept plan is approved, the Department shall determine that the applicant has complied with this section.*

DPIE will issue a case number for the SDCP at the time of submittal. The applicant shall ensure that the Site Development Concept Plan case number is referenced on all public notification letters. A suggested format and language for the notification letter to be sent to adjacent property owners including properties that lie directly across the street, alley, or stream is contained in Appendix 5-5. The required affidavit that all parties have been notified is also in Appendix 5-6. The applicant shall confirm the municipalities and registered civic associations to be notified per County Code Sec. 27-125.01 for the site through inquiry with the M-NCPPC Planning Information Services on the Lower Level of the County Administration Building in Upper Marlboro.

The letters must be mailed within 1 week of the Site Development Concept Plan submittal to the County. The applicant shall provide copies of the SDCP to all parties that request it and shall document and respond to concerns raised by the public during this process. The applicant must provide an Affidavit to DPIE at the time of second review of the SDCP, to verify that the notification process was followed.

## **5.6 SDCP Validity/Extensions/Revisions**

Once an SDCP has been approved, it represents the development goals to be achieved for the site. A revised SDCP letter must be obtained if a significant change to the site development is made. It is not the objective to have the SDCP exactly match the Final Plan. In other words, if the goal established at the SDCP is met and the impervious percentage does not increase by more than 5%, then it is the applicants' responsibility to meet the goal that was approved under the SDCP.

For example, if a site was approved with an area that is 65% impervious, and the impervious area is increased to 70%, this is acceptable. With either a reduction or increase in the impervious area, the facility size or the number of facilities will need to be adjusted based on the final configuration. However, if the impervious percentage changes by more than 5%, then a revised SDCP is required.

An approved SDCP expires after a maximum of 3 years. A letter requesting an extension with a review fee of \$100 is required as long as the project is active. The SDCP approval letter must be kept current throughout the life of the project. The request should include a copy of the current SDCP approval letter.

## 5.7 Application Form

The application form is an important document for the County and the other reviewing agencies as it contains information about the site and surrounding areas that is used for tracking, description, recognizing locations where there are important national or historic resources, and identifying other constraints to development. Some of the requested information is relatively obvious such as the site area, current zone of property, WSSC 200-foot map grid, etc. However, other items require additional explanation so that the appropriate information is provided.

**Current Zone** - This is the current zone of the property. If the SDCP is for a rezoning application (which is not a requirement of rezoning), then include the proposed zone in the proposed zone box.

**Total Site Area** - Provide the total area of the property included in the application.

**Estimated Disturbed Area** - This is an estimated total of disturbed area based on the approximate LOD to construct the project. This is only to be used as guidance and will be further refined in later design documents. It is also used in the determination of the existing impervious percentage to decide if the project is redevelopment or will need to use the new development standards.

**Proposed Zone** - If a rezoning is proposed, provide zone designation.

**Total Number of Lots/Parcels** - Indicate the estimated number of residential lots or units based on allowable densities. If commercial or industrial, include the number of lots and/or parcels.

**County Watershed Name** - Provide the name of the County Watershed such as Anacostia, Indian Creek, Piscataway Creek, etc. , where the project is located. This will geographically define the location in the County as compared to the 12-digit Maryland code.

**Master Plan Name** - Provide the M-NCPPC Master Plan Name and Master Plan number or Sector Plan Name where the project is located. This is required as the Master Plan or Sector Plan may have specific design criteria for the site or the surrounding area that may be incorporated into the SDCP.

**County Election District** - Indicate the County election district in which the project is located. The location may be found in PGAtlas.

**Tax Map/Grid** - Provide the Prince George's County tax map and grid. This information may be found in PGAtlas.

**Tax Account Number** - Provide the tax account number or numbers for the project area. They may be obtained from PGAtlas.

**WSSC 200-foot Grid** - Provide the 200-foot grid such as 206NE7. They may be found in PGAtlas.

**County Council District** - Provide the County Council District number of 1 to 9, which may be found in PGAtlas.

**Municipality** - Provide the name of the municipality or municipalities where the project is located.

**Public Project** - This applies to any County-affiliated agencies, the Board of Education, WSSC, municipalities, and M-NCPPC DPR. In many cases, special review fee arrangements would apply. State and Federal projects will be reviewed by MDE for compliance with State law if the applicant is a State or Federal agency.

**Maryland 12 Digit Watershed Code** - Provide the 12-digit Watershed code from the State. This information may be used as part of the required MS-4 reporting requirements for the County, and collecting this information will assist in the reporting.

**Impaired Watershed** - A number of impaired watersheds with TMDL allocation for sediment, nitrogen, or phosphorus, are important for the County as part of the MS4 reporting requirements. Projects in these watersheds may require modifications to the SWM control or sediment control requirements depending upon location of the project to the impaired areas. Indicate name of watershed in box. A map of the impairments within the County may be found at this website for sediment:

[TMDL Impaired Watersheds](#)

The Nutrient map is located at the following State website:

[Nutrient Impairments and TMDLs](#)

**Types of Impairment** - A watershed may be considered impaired for multiple reasons. The specific impairments the County is concerned about are nitrogen, phosphorous, and sediment. Watersheds with these impairments may require additional controls or measures, which shall be identified in the report. Enter N for nitrogen, P for phosphorus and S for sediment.

**Tier 2 Watershed** - Several areas in the County are located in what are called Tier 2 watersheds. These are defined in COMAR 26.08.02.04 in more detail. In addition, there are also Tier 2 streams, which contain higher quality water, and additional protection may be required for these bodies of water, such as additional buffers and more water quality controls. The location of these watersheds may be found at this State website:

[Prince George's County Tier II Waters \(PDF\)](#)

**Historic Site** - Provide the local, State, or Federal name of the designated historic site. This could include the identifying number for a County or State historic site. The location of the County sites is available through this website and PGAtlas.



### M-NCPPC Historic Preservation

This information also needs to be provided if the project is adjacent to a historic site as the view shed could extend across the property line.

**Historic Site Number** – Provide the M-NCPPC historic site number(s).

**Scenic or Historic Road** - The County has identified scenic and historic roads, and they may be found in PGAtlas. If the project frontage requires road improvements, the allowable impacts for the road must be accounted for, including potential SWM measures that may need to be modified in order to maintain the scenic or historic nature of the road. Answer Yes or No and if the answer is Yes, explain further in the report.

**Closed/Open Road Section** – Enter Yes or No to indicate if the road frontage and proposed roads in project are either open or closed road sections. It is possible for a project to have both types of road sections. For projects that are already on developed sites, the intent is to indicate the type of existing road frontage even though frontage improvements may not be required.

**Existing Site Impervious Area** – Provide the existing impervious area for new development type projects only.

**Existing Impervious Area in LOD** - This information is needed to assist in the calculation to determine if a project qualifies as a redevelopment site versus a new development site.

**New Site Impervious Area** – Provide the estimated site impervious area proposed for the project.

**Existing Impervious Area to be Removed** – If impervious area will be removed, provide the estimated area. This information will assist the County in identifying areas that may be used to meet the Phase II Watershed Implementation Plan requirements by EPA and MDE for the County.

**Existing Impervious Area Previously Treated** - This information is necessary to verify if the County records are correct for the type of quality or quantity treatment for the areas that were previously approved. This also requires that the existing SWM facilities will need to be operational. Additional information on the type of facilities including treatment volumes and operations shall be provided in the report.

**Hot Spot** - If the project use as proposed meets the requirements of a hotspot please indicate as Yes. In addition, provide the type of hotspot that is proposed. See Section 5.3.3.7 for a list of the types of hotspots.

**Marlboro or Sulfidic Clay** - Indicate if the site contains Marlboro or sulfidic clays. Some information may be obtained from PGAtlas or by contacting PGSCD. This information is important as either SWM requirements or erosion and sediment control measures may

be modified, depending upon the presence of these clays and where they are located with respect to the proposed development.

As a last step on the application, provide the proposed use or activity for the site and all previous approvals with a copy of the resolution.

This Page Intentionally Left Blank

## Chapter 6 SITE DEVELOPMENT PLAN

### 6.1 Purpose, Jurisdiction and Process

Processing of an SDP achieves the second phase of the MDE three-phase process, as outlined in the 2000 *Maryland Stormwater Design Manual, Volumes I and II* (MDE, 2000 and 2009 (*Maryland Design Manual*)). County Code Sec. 32-182 (b) defines this Site Development Plan process as follows:

(b) *Site Development Plan.*

*Following concept plan approval by the Department, the owner/applicant shall submit technical plans that reflect the comments received from the previous concept plan review phase. Plans submitted shall be of sufficient detail to allow site development to be reviewed and shall include but not be limited to:*

- (1) *All information provided during the concept plan review phase;*
- (2) *Final site layout, exact impervious area locations and acreages, proposed grading, delineated drainage areas at all points of discharge from the site, and storm water volume computations for ESD practices and quantity control structures;*
- (3) *A proposed erosion and sediment control plan that contains the construction sequence, any phasing necessary to limit earth disturbances and impacts to natural resources, and an overlay plan showing the types and locations of ESD and erosion and sediment control practices to be used;*
- (4) *A narrative that supports the site development design, describes how ESD will be used to meet the minimum control requirements, and justifies any proposed structural storm water management measure; and*
- (5) *Any other information required by the Department.*

#### 6.1.1 Purpose

The purpose of the SDP is for review agencies to conduct an intermediate review of the SWM and sediment control aspects of the project. This step provides an opportunity for agency review and feedback, once the project site plan is better defined, and opportunities for incorporating ESD can be further considered. It is important at this stage in the planning process to continue to coordinate closely with M-NCPPC if a concurrent development review process is pending.

#### 6.1.2 Process – Submittal Procedures Site Development Plan

After SDCP approval, the applicant shall submit a Site Development Plan (SDP) for review and approval. Preparation of an SDP will include more detailed design of SWM facilities and Erosion and Sediment Control. During this second step, the site

footprint will be finalized with respect to the layout of buildings, roadways, parking, grading, and other structures, in order to develop more detailed design information.

DPIE will issue feedback and approval in the form of a Site Development Plan Approval Letter. PGSCD will issue feedback and approval in the form of an approved Environmental Site Development Grading, Erosion, and Sediment Control Plan.

Combining the SDP and Final Plan Phase: Certain projects are eligible for combining the SDP with the Final Plan. Unless otherwise required by the SDCP, any by-right zoned project that does not require a Preliminary Plan of Subdivision or Entitlement Site Plan (Special Exception Plan, Detailed Site Plan, Specific Design Plan, Special Permit, or CBCA) and does not require an SWPPP may proceed to a combined Site Development/Final Plan process. The three-phase process for SDP review by DPIE will be applicable to projects that require an entitlement site plan. Applicants should consult with PGSCD regarding requirements for the three-phase review processes: Concept, Environmental Site Development, and Final Grading, Erosion, and Sediment Plan.

For entitlement site plan projects, the applicant will submit the Site Plan directly to the M-NCPPC. This plan will be referred to DPIE for SDP approval. This review is considered part of the overall entitlement site plan submittal process, and a copy of it shall be included in the M-NCPPC submittal package. The applicant shall submit the Environmental Site Development Grading, Erosion, and Sediment Control Plan directly to PGSCD for all cases.

For non-entitlement site plan projects, the SDP shall be submitted directly to DPIE (either combined or separate phase submittals). DPIE, M-NCPPC, and PGSCD will collaborate to provide coordinated feedback to the design consultant before a project proceeds to the Final Design phase.

This feedback will accompany the SDP approval and should be incorporated into future submissions. The review process will pay particular attention to feasibility of design and if the required ESD/SWM volumes identified on the plan have been met or if additional ESD can be achieved. Also of interest is how the individual devices will be protected from construction equipment and sediment trapping devices.

### **6.1.3 Process - Review Time Frames for SDP**

In many cases, the review of a SDP will need to track concurrently with the review schedule of an entitlement site plan. Timeframes for the review of the entitlement site plan are established by Subtitle 27 and will need to be followed. In general, the entitlement site plan will be reviewed by the Planning Board within 70 days of acceptance unless a waiver is granted by an applicant. This also requires initial review of the entitlement site plan by all agencies to be complete within 2 to 3 weeks of acceptance, for presentation of comments to the Development Review Committee.

Therefore, the following general review timeframes by agencies and applicants are proposed for SDPs associated with entitlement site plans:

- A. DPIE will provide written comments in the form of a Site Development Plan Referral Letter to the applicant and M-NCPPC based on the referral plan from M-NCPPC.

- B. The applicant will be required to address SDRC comments within 15 days of receipt of comments, so that all agencies can complete their review in time for the issuance of a draft resolution for the Site Development Plan and transmittal to Planning Board.

Failure of the applicant to address the comments may affect the setting of a Planning Board hearing date for the entitlement site plan.

In the event that no entitlement site plan is required, DPIE will issue a Site Development Plan Approval Letter (See Appendix 6-1 for example) if there are no significant issues to address or comments to be addressed will be issued.

The applicant will be required to address the SDP review comments as part of the Final Plan process.

## 6.2 SDP Preparation

The following plans will be required for Site Development Plan review:

- A. Entitlement site plan with ESD and SWM design
- B. Environmental Site Development Grading, Erosion, and Sediment Plan
- C. An Overlay Showing Stormwater and Erosion and Sediment Control Practices that will generally be the Environmental Site Development Grading, Erosion, and Sediment Plan, as it will show all impacts.

Instead of all three, the applicant may submit 6.2 A and C.

### 6.2.1 SWM Design

After SDCP approval, the applicant should solicit comments and feedback as the desired outcome of the SDP phase. When the development layout is finalized, the proposed topography is determined and final drainage areas established. Natural features and conservation areas may be utilized to meet storm water quality and quantity management requirements. Individual ESD locations will be determined and all alternative surfaces, nonstructural, and micro-scale practices will be finalized. When locating and sizing ESD practices, the primary objective is to manage runoff as close to its source as possible by using vegetated buffers, natural flow paths, sheet flow to natural areas, and landscape features. ESD practices are designed according to sizing requirements specified in Chapter 10, and discharge computations and storage volumes will be provided. ESD sizing calculations and sufficient details will be submitted to the County to verify the design approach. A narrative will also be required to justify that the design will achieve ESD to the MEP. Please refer to the section below regarding specific submittal requirements.

### 6.2.2 Erosion and Sediment Control Design/Overlay Plan

The requirements for the SDP, as they pertain to erosion and sediment control, are outlined and defined in the PGSCD's latest edition of the *Soil Erosion and Sediment Control – Pond Safety Reference Manual*, Chapter II. This plan will overlay the SWM and erosion and sediment control measures.

Many of the storm water ESD practices deal with alternative surfaces or are nonstructural and promote hydraulic connection of impervious surfaces with natural landscape features. The practices for SWM and erosion and sediment control may share the same location while serving different functions. For example, swales used initially to convey sediment-laden runoff to a trap or basin during the sediment control phase could be used for water quality treatment and flow attenuation of storm water runoff after construction completion. Similarly, natural berms and vegetative buffers coupled with traditional sediment filtering controls may be integrated into the site design and meet both sediment control and SWM requirements.

Once the ESD practices have been located and sized appropriately, consideration of how these areas will function under proposed conditions is needed. The location of any ESD practice that requires natural infiltration needs to be identified on the plans and in the field. These areas need to be protected during construction. An overlay plan should include the location of all ESD practices to allow for efficient sediment control design and the protection of locations that will be used to treat storm water.

### 6.2.3 Submittal Requirements

The SDP package submitted to DPIE should include a storm water plan with SWM and ESD devices, grading, computations, geotechnical report, Environmental Site Development Grading, Erosion and Sediment Control Plan; and a narrative to support the ESD, SWM, and sediment control design. With regard to the submittal requirements of DPIE, the applicant can choose to display this information on the Entitlement Site Plan or Type 2 Tree Conservation, and to submit a separate narrative report and drainage area map, to avoid the need for a separate SDP. This submittal package should include any previously approved site plans or PPS.

To reduce multiple reviews and time-consuming back and forth communications, the plans will be screened by DPIE. If the required information is not present, the plans will not be accepted for processing and review. The application form, submittal checklist, and design review checklists are available on the DPIE website.

The review agencies may require additional information at this phase because of the type of project; however, at a minimum an SDP shall include the following:

- A. All of the information provided in the SDCP review. Note: If the SDCP package was submitted digitally, this information does not need to be provided to DPIE with the SDP review phase.
- B. Comments received by review agencies during the SDCP review.

- C. Final site layout with features such as buildings, parking, sidewalks, and green space, as well as acreage of total impervious area on site.
- D. Existing and proposed topography at 2-foot or more accurate contour interval.
- E. A drainage area map at 1"=50' (preferred), up to 1"=200' if the information is legible, showing the location of storm water ESD practices and a tabulation of required versus provided volumes for the SWM devices. The map shall include proposed drainage areas to all points of discharge from the site and to each ESD device.
- F. Proposed hydrology analysis for runoff rates, storage volumes for ESD targets, quantity control, and discharge velocities. This includes the release rates for an SWM facility for any storm event that required mitigation per the SDCP. Provide this information in tabular form in the report and on the Drainage Area Map.
- G. The location and size of ESD practices proposed to the MEP and all other structural, alternative surfaces, and micro-scale practices used.
- H. Discharge calculations demonstrating stable conveyance of runoff off site.
- I. A narrative to support the site development design and demonstrate that ESD will be achieved to the MEP.

### 6.3 SDP Validity, Extensions, and Revisions

The SDP approval, issued by DPIE, if related to an entitlement site plan, shall match the expiration date of the SDCP. If the SDCP requires an update, the SDP will also need to be updated if the permit has not been issued. Once a construction permit is issued for the area of the SDP, then only the SDCP will need to be updated.



This Page Intentionally Left Blank

---

**Chapter 7 FINAL PLAN****7.1 Purpose and Jurisdiction**

The Final Plan or Phase 3 of the MDE three-phase process will result in the issuance of permits by the County to allow activities such as grading and constructing storm drains, SWM, ESD, paving, and building. At a minimum, the Final Plans shall include the information required by COMAR 26.17.01.05 and 26.17.02 .09 and County Subtitle 32. The County Code Sections 32-182 (c) to (f) and 32-184 guides this process and is given below:

(c) *Final Stormwater Management Plan.*

*Following the site development plan review by the Department, the owner/applicant shall submit a final storm water management plan for permit issuance. Plans submitted for permit issuance shall be of sufficient detail to allow all approvals and permits to be issued according to the following:*

- (1) *Final erosion and sediment control plans shall be submitted according to COMAR 26.17.01.05; and*
- (2) *The final storm water management plans shall be submitted for approval in the form of construction drawings and be accompanied by a report that includes sufficient information to evaluate the effectiveness of the proposed runoff control design.*

(d) *Reports submitted for an approval of final storm water management plans shall include, but are not limited to:*

- (1) *Geotechnical investigations including soil maps, borings, site specific recommendations, and any additional information necessary for the storm water management design plan;*
- (2) *Drainage area maps depicting predevelopment as applicable and post development runoff flow path segmentation and land use;*
- (3) *Hydrologic computations of the applicable ESD and unified sizing criteria according to the Maryland Design Manual for all points of discharge from the site;*
- (4) *Hydraulic and structural computations for all ESD practices and structural storm water management measures to be used;*
- (5) *A narrative that supports the storm water management design plan; and*
- (6) *Any other information required by the Department.*

(e) *Construction drawings submitted for final storm water management plan approval shall include, but are not limited to:*

- (1) *A vicinity map;*

- (2) *Existing and proposed topography and proposed drainage areas, including areas necessary to determine downstream analysis for proposed storm water management facilities;*
  - (3) *Any proposed improvements including location of buildings or other structures, impervious surfaces, storm drainage facilities, and all grading;*
  - (4) *The location of existing and proposed structures and utilities;*
  - (5) *Any easements and rights-of-way;*
  - (6) *The delineation, if applicable, of the 100-year floodplain and all regulated environmental features as shown on the approved NRI;*
  - (7) *Structural and construction details including representative cross sections for all components of the proposed drainage system or systems, and storm water management facilities;*
  - (8) *All necessary construction specifications;*
  - (9) *Sequence of construction;*
  - (10) *Data for total site area, disturbed area, new impervious area, and total impervious area;*
  - (11) *A table showing the ESD and unified sizing criteria volumes required in the Maryland Design Manual;*
  - (12) *A table of materials to be used for storm water management facility planting;*
  - (13) *All soil boring logs and locations;*
  - (14) *An inspection and maintenance schedule;*
  - (15) *Certification by the owner/applicant that all storm water management construction will be done according to this plan;*
  - (16) *An as-built certification signature block to be executed after project completion; and*
  - (17) *Any other information required by the Department.*
- (f) *If a storm water management design plan involves direction of some or all runoff the site, it is the responsibility of the applicant to obtain from adjacent property owners any easements or other necessary property interests concerning flow of water. Approval of a storm water management plan does not create or affect any right to direct runoff onto adjacent property without that property owner's permission.*

*Sec. 32-184. Permit Requirements.*

- (a) *A grading or building permit shall not be issued for any parcel or lot unless a final erosion and sediment control plan has been approved by the Prince George's County Soil*

*Conservation District, and the final storm water management plan has been approved by the Department as meeting all of the requirements of this Division. Where appropriate, building, storm water management, or grading permits shall not be issued or modified without the following:*

- (1) A performance bond acceptable to the County Attorney as required by this Division, where applicable.*
  - (2) Recorded easements for the storm water management facilities that provide adequate access for inspection and maintenance from a public right-of-way.*
  - (3) Approved final storm water management plan, provided that the Director may accept a site grading plan that identifies the location and type of facilities to be constructed in sufficient detail to accurately estimate construction costs.*
- (b) Notwithstanding any of the provisions herein, the Director may require an approved final storm water management plan and the recordation of all necessary easements prior to issuance of a building permit or grading permit.*
- (c) In no event shall a use and occupancy permit be granted until all of the grading and storm water management requirements are completed to the satisfaction of the Director.*
- (d) Approved final storm water management plan shall contain certification by the applicant that all land clearing, construction, development, and drainage shall be undertaken in accordance with the approved final storm water management plan.*

## **7.2 Final Plan Phase (SWM & Storm Drain) -**

After SDP approval (MDE Phase 2 and County Chapter 6) the applicant shall process the Final Plan (MDE Phase 3). This involves preparation of the final design plans for subsequent plan review and permitting for construction. It also requires the applicant to incorporate previous review comments from the first two phases from the review agencies. DPIE will review the final SWM, ESD, and storm drain plan and other associated documents, and will issue one of three permit types. In many instances, the SWM, ESD, and storm drain plan also include paving and roadway construction.

### **7.2.1 Site Development Rough Grading Permit (SDRG)**

An SDRG allows for construction of rough grading, water, sewer, storm drain, and SWM facilities. This permit can include SWM facilities, which are often utilized during rough grading to double as sediment control basins during the grading process. This permit will not include the smaller scale ESD devices such as bio retention, bios wales, infiltration trenches, pervious paving, submerged gravel wetlands, and other such small-scale measures. These types of devices are best constructed at the end of the project, prior to stabilization, to avoid clogging of sediment during the construction phase. The SDRG permit does not support a building permit except for retaining walls, and only supports rough grading and initial site work. This permit type is often pursued to allow for early construction start for the land development project. This permit will also allow for the grading

and land disturbance necessary for water and sewer construction; however, construction of water and sewer requires separate WSSC approval and permits. The storm drain or SWM plans to accompany this permit application must include the submittal checklist and design review checklists specific to the type of plans included for review, which are available on the County website.

In addition to reviewing the storm drain or SWM facilities, the County will also review the rough grading on the site and determine if it meets County code requirements under Subtitle 32 Division 2.

Other items required for the County to issue SDRG permits could include:

- A. Site Development Concept Plan Approval Letter: This approval is required for issuance of any permit in the County unless the project meets the exemption requirements of County Code Sec. 32-174.
- B. Street Grade Establishment Plan: If public streets are included in the permit limits, a Street Grade Establishment Plan approval will be required before permit issuance.
- C. Existing 100-Year Floodplain: If the site contains existing 100-year floodplain limits, the existing 100-year floodplain approval will be required before permit issuance.
- D. Proposed 100-Year Floodplain: If floodplain fill is proposed as part of the rough grading or if a culvert or bridge will be installed, a separate proposed 100-year floodplain approval must be obtained before permit issuance.
- E. Rough Grading Erosion/Sediment Control: This plan approval by PGSCD is always required before permit issuance.
- F. Type 2 Tree Conservation Plan or Woodland Conservation Exemption Letter by M-NCPPC: This plan approval (or exemption letter) is always required before permit issuance.
  - Transfer Certificate for Off-Site Woodland Conservation Bank (Off-site Mitigation)
- G. CBCA Conservation Plan: If the site is in the CBCA, a CBCA Conservation Plan is required. The following item must be included:
  - Transfer Certificate for Off-Site Conservation Area
- H. Entitlement Site Plan: In some zones, a Preliminary Plan of Subdivision and/or a Detailed Site Plan or similar entitlement site plan approval is

required before permit issuance. Consult with M-NCPPC and County Code Sec. 27-270 for further guidance.

- I. M-NCPPC Approval of Permit: This approval is required for compliance with the Planning Board approvals, Subtitle 24, and Subtitle 27 and any conditions from M-NCPPC Planning Board and District Council before approval of the permit.
- J. Health Department: This is required for any site that has a water well or septic system.
- K. Record Plat or Road Dedication: In some zones, a record plat is required before permit issuance. Consult with M-NCPPC and Subtitle 24 for further guidance on record plats.
- L. Fees: A number of fees are required prior to permit issuance:
  - CBCA Fee-In-Lieu (County Code Sec. 32-112)
  - SDRG Permit fees (County Code Sec. 32-120 and 23-115)
    - 100% of the full fee requirement indicated on the grading fee schedule, plus
    - 10% of the construction cost estimate for any work within the public right-of way, plus
    - \$3.00/lineal foot of public pipe, \$1.50/lineal foot of private pipe
  - Woodland Conservation Fee-In-Lieu (County Code Sec. 32-120)
  - Pond Maintenance Fee for public systems (County Code Sec. 32-185)
  - Payment of any other project related fees
- M. Bonds: Bond estimate are separated into parts for review and approval as noted below.
  - Cost Estimate for Work in Public Road Right-of-Way (All work in Right-of-Way including Storm Drain, Stormwater Management, and Grading)
  - Cost Estimate for Work Outside Public Road Right-of Way (Public Storm Drain and SWM)

- Cost Estimate for Grading Outside Public Right-of Way based on disturbed area
  - Obtain amount from M-NCPPC for Reforestation/ Afforestation Bond
- N. Recorded Easements: Once the executed easement document is delivered to the County, this requirement for permit release will have been satisfied.
- O. Recorded Declaration of Covenants: This is required for private storm or SWM systems.

If after 6 months a permit has not been issued, a permit extension request letter will need to be submitted by the applicant.

### 7.2.2 SDFG Permit

This permit incorporates all development activity on the site including but not limited to storm drain, ESD, SWM, paving, dry utilities, building, and grading. This is the most comprehensive site permit that the County issues and is the preferred permit. The submittal checklist for a fine grading permit is on the County website, and it is imperative that the design consultant submit all required information, as well as the completion of one or more design review checklists for the work proposed under the permit.

If after 6 months a permit has not been issued, a permit extension request letter will need to be submitted by the applicant.

In addition to the items required for an SDRG permit, the following may be required or supplemented for an SDFG permit.

- A. Final Sediment and Erosion Control Plan: This plan approved by PGSCD allows all construction for grading, roads, paving, and buildings.
- B. Fees: A number of fees are required prior to permit issuance if not paid under the SDFG.
- Police/Fire/Rescue Mitigation fee\*, if applicable (County Code 24-122.01 and .02)
  - CBCA Fee-In-Lieu (County Code Sec. 32-112)
  - SDFG Permit fees (County Code Sections 23-115 and 32-120)
  - 100% of the full fee requirement indicated on the grading fee schedule not previously paid as part of the SDRG permit, if applicable, plus

- 10% of the construction cost estimate for any work within the public right-of way, plus
  - \$3.00/lineal foot of public pipe, \$1.50/lineal foot of private pipe
  - Woodland Conservation Fee-In-Lieu (County Code Sec. 32-120)
  - SWM Fee-In-Lieu (County Code Sec. 32-179 (b))
  - Pond Maintenance Fee for public systems (County Code Sec. 32-185)
  - Payment of any other project related fees
- C. Bonds: Bond estimate separated into parts for review and approval as noted below.
- Cost Estimate for Work in Public Road Right-of Way (All work in public road Right-of Way including Storm Drain, Stormwater Management, ESD, Roadway, Grading, Street Trees, and Bridges)
  - Cost Estimate for Work Outside Public Road Right-of Way (Public Storm Drain, ESD, and SWM and Private Roads in Townhouse or Single Family Subdivisions)
  - Cost Estimate for Grading Outside Public Right-of Way (Based on disturbed area)
  - Reforestation/ Afforestation Bond (Obtain amount from M-NCPPC)
- D. Final SWM, Storm Drain, and Paving Plan: Necessary plans to construct storm drain, SWM, ESD, or roads. The following plans could be approved as part of this package to comply with the M-NCPPC resolution or Subtitle 23.
- Approved Bridge Plan, if applicable
  - Traffic Signal Permit Issued, if applicable
  - Pavement Marking and Signage Plan, if applicable
  - Maintenance of Traffic Plan, if applicable
  - Street Tree and Lighting Plan, if required



- Offsite/Road Improvement Permit Issued, if required
- E. Recorded right-of-way deed and/or easement documents not previously recorded.
- F. Recorded Declaration of Covenants: This is required for private storm or SWM systems.

If after 6 months a permit has not been issued, a permit extension request letter will need to be requested by the applicant.

### 7.2.3. Street Construction Permit

This permit will generally be used for County Capital Improvement Plan (CIP) projects, on or off-site road improvement, or road improvements along the frontage of a proposed development. The intent of this permit is for street construction only. This includes storm drain, paving, SWM, ESD devices, street trees and lights, MOT, and signing and marking plans. Road grading and grading required outside the right-of-way to meet existing grade is also permitted. This permit shall not be used for grading that is not associated with public roadway construction or offsite ESD or SWM facilities.

- A. Site Development Concept Plan Approval Letter: This approval is required for issuance of any permit in the County unless the project meets the exemption requirements of County Code Sec. 32-174.
- B. Street Grade Establishment Plan: A Street Grade Establishment Plan approval will be required before permit issuance.
- C. Existing 100-Year Floodplain: If the site contains existing 100-year floodplain limits, then existing 100-year floodplain approval will be required before permit issuance.
- D. Proposed 100-Year Floodplain: If floodplain fill is proposed as part of the grading or culvert or bridge crossings that will impact the floodplain, a separate proposed 100-year floodplain approval and dedication of an easement for any increase in floodplain area must be obtained before permit issuance.
- E. Type 2 Tree Conservation Plan or Woodland Conservation Exemption Letter by M-NCPPC: This plan approval (or an exemption letter) is always required before permit issuance.
- Transfer Certificate for Off-Site Woodland Conservation Bank (Off-site Mitigation)

- 
- F. CBCA Conservation Plan: If site is in the CBCA, a CBCA Conservation Plan is required, and the following items must be included:
- Transfer Certificate for Off-Site Conservation Area.
- G. Entitlement Site Plan: In some zones, a Detailed Site Plan or other such entitlement site plans are required before permit issuance. Consult with M-NCPPC and County Code Sec. 27-270 for further guidance.
- H. Final Sediment and Erosion Control Plan: This plan approved by PGSCD allows for activities such as grading, construction of roads and buildings, and paving.
- I. Fees: A number of fees are required prior to permit issuance if not paid under the SDRG or Street Construction Permit.
- CBCA Fee-In-Lieu (County Code Sec. 32-112)
  - SDRG Permit fees (County Code Sections 23-115 and 32-120)
    - 100% of the full fee requirement indicated on the grading fee schedule, plus
    - 10% of the construction cost estimate for work within the public right-of-way, plus
    - \$3.00/lineal foot of public pipe, \$1.50/lineal foot of private pipe
  - Woodland Conservation Fee-In-Lieu (County Code Sec. 32-120)
  - SWM Fee-In-Lieu (County Code Sec. 32-179 (b))
  - Pond Maintenance Fee for public systems (County Code Sec. 32-185)
  - Payment of any other fees related to the project
- J. Bonds: Bond estimate is separated into parts for review and approval as noted below.
- Cost Estimate for Work in Public Road Right-of Way (All work in public road right-of-way including storm drain, SWM, roadway, grading, street trees, and bridge)

- a. Performance Bond – 125% of approved construction cost estimate plus grading bond amount.
  - b. Labor and Materials Bond – 40% of performance bond amount.
  - Obtain amount from M-NCPPC for Reforestation/ Afforestation Bond
- K. Final Plan: Necessary plans to construct storm drain, SWM, ESD, or roads. The following plans could be approved as part of this package to comply with the M-NCPPC resolution or Subtitle 23.
- Approved Bridge Plan, if applicable
  - Traffic Signal Permit Issued, if applicable
  - Pavement Marking and Signage Plan, if applicable
  - Maintenance of Traffic Plan, if applicable
  - Street Tree and Lighting Plan
  - Offsite/Road Improvement Permit Issued, if required
- L. Recorded right-of-way deeds not previously recorded.
- M. Recorded Easements: These easements, either as separate documents or as shown on the record plat, could include types such as Conservation, Floodplain, Storm Drain, and SWM.

If after 6 months a permit has not been issued, a permit extension request letter will need to be requested by the applicant.

#### **7.2.4 Other Approvals or Permits**

Approvals or permits required by other agencies may be needed before construction may start or impact the specific area of concern by the agency or utility. The County will not hold up the issuance of their permit; instead it is the responsibility of the permittee to obtain the required approval or permit. The following is a list of some but not necessarily all agencies or utilities that may require a permit or approval.

- Public Utility Relocation or Impact
- FEMA Approval of Impacts to Floodplain

- MSHA Access Permit or MSHA Public Improvement Plan unless required by resolution prior to a grading permit issuance.
- USACE/MDE Wetland Permit unless required by M-NCPPC resolution prior to permit issuance.
- NPDES Permit from MDE
- WSSC Plan Approval for extension of water and/or sewer facilities or Relocation Plan
- Impacts to State or Federal property

### 7.3 Final Design Plans

Design plan sheets submitted shall be no larger than 24 x 36 inches. The plans shall reserve 5 inches of space on the right-hand border of all sheets for DPIE approval stamps. See Appendix 7-1 for examples. The drainage area map, soils analysis, and hydraulic computations may be included on the design drawings or as separate documents. All documents must be suitable for scanning and/or reduction. All plans and computations must be signed and sealed by the design consultant.

- A. Drawings shall be prepared in conformance with the General Drafting Standards (Chapter 2) and shall clearly and concisely indicate all items outlined on the appropriate design checklist that may be found on the DPIE website.
- B. The General Notes for Storm Drain, Paving, and SWM as appropriate shall be on the first page of the drawings. See Appendix 7-2 for notes.
- C. All drawings shall clearly show the construction phasing as it relates to the development construction, if applicable.
- D. All drawings must include a title block, project name, design consultant's information block, owner/applicant information block, and sheet index (if necessary).
- E. Follow the guidelines on the appropriate design review checklist(s) according to the design plan scope..
- F. Supporting computations and descriptions shall be bound in a report sized to 8 1/2" x 11". Larger sheets may be folded to an 8 1/2" x 11" footprint.

### 7.4 Submittal of Plan Drawings and Documents

- A. Submission requirements for technical review and approval of storm drain design are as follows:
  1. **All Projects** - The plan review starts with the filing of a permit. Follow the instructions on the submittal checklist for the permit. All applications

shall be made on the first floor of 9400 Peppercorn Place to the DPIE Site/Roads Permit Unit.

2. **DPIE Review:** Permit applications are reviewed on a first-come, first-served basis.

## 7.5 Permitting Requirements and Fees

The permit process is described in a flowchart in Appendix 3. In addition to meeting the requirements of storm drain and SWM plan approval, before a DPIE site development permit can be issued, the requirements specific to the permit described in Sections 7.2.1 to 7.2.3 and the submittal checklists must be satisfied, as appropriate for the project:

If agency assistance is necessary to review the requirements for your project, please contact DPIE at (301) 883-5710. When making inquiries, have the permit case number that has been assigned to the project and the name of the project.

## 7.6 Final Plan Validity, Extensions, and Revisions

### 7.6.1 Permit Validity

Depending on the scope of a permit, the validity period could vary. However, there are certain limitations that must be followed for each type of permit as described below.

#### SDRG Permit

1. Grading not in public right-of way - Up to 5 years with a one-time extension (not to exceed 1 year) for a maximum of 6 years. See County Code Sec. 32-143 for additional guidance.
2. Storm Drain, SWM, and public right-of way Grading - Two years if the performance bond amount is less than \$500,000 and 3 years if performance bond amount is greater than \$500,000. The permits may be extended for a maximum valid period of 6 years. See County Code Sec. 23-122 for additional information.

#### Site Development Fine Grading Permit

1. Storm Drain, SWM, Grading, and Roads - Two years if the performance bond amount is less than \$500,000 and 3 years if the performance bond amount is greater than \$500,000. The permit may be extended for a maximum valid period of 6 years. See County Code Sec. 23-116(e)(2) for information on when a labor and material man (L&M) bond would be required.

#### Street Construction Permit

1. Storm Drain, SWM, and Roads - Two years if the performance bond amount is between \$50,001 and \$500,000, and 3 years if the performance

bond amount is greater than \$500,000. There is no limit to the number of extensions. See County Code Sec. 23-116(e)(2) for information on when an L&M bond would be required.

**7.6.2 Extensions to Approved Permits**

A grading permit may be extended in accordance with County Code Sec. 32.105 (a) as follows;

- (a) *Any permit issued for grading pursuant to this Subtitle shall be issued only for a period of time reasonably necessary to perform the work, a period not to exceed 5 years. Where a permit is issued to correct a violation, the permit shall not exceed ninety (90) days. The initial period of the permit shall be established by the Director based upon the extent of the work required to correct the violation. The permit may be extended or renewed for an additional period of one year if, in the opinion of the Director, the applicant has demonstrated substantial progress to complete the work in accordance with the permit and has demonstrated substantial justification for failure to complete the work within the period of the permit. The Board of Appeals shall have no authority to grant an extension to the period of the permit.*

A permit that includes site, roads, or building construction shall meet the requirements of County Code Sec. 23-122 (a) for the extension of a permit.

- (a) *Extension. The Director is authorized to grant or deny a request for extension of time for a permit, where a permittee is or will be unable to complete the work, as determined by the Director, within the time allowed.*
  - (1) *It shall be the responsibility of the permittee to apply for an extension not less than thirty (30) days prior to the expiration date of the permit. Such request shall be in writing and shall state the reasons for extension and the time required to complete the work.*
  - (2) *Where the permittee has requested an extension of a valid permit prior to its expiration and, through no fault of his own, the extension has not yet been granted or denied by the Department, the permittee may continue work under the permit. If the request for extension of the permit is denied, all work will cease immediately. Such denial may be appealed as provided herein.*
  - (3) *Where the Director determines that an additional bond amount is necessary because of inflation or other factors, the permittee shall be required to post the additional bond in an amount determined by the Director before the extension of time is granted. Where the permittee is working under the provisions of Section 23-122(a)(2), a grace period of ten (10) working days will be allowed for the posting of additional bond. Failure to post the additional bond during the ten (10) day period will cause the permit to be automatically suspended.*

- 
- (4) *The Director shall decide upon the request for extension and shall notify, in writing, the affected bonding institution and the applicant of his decision within twenty (20) working days of a formal request. This decision shall be contingent upon the payment of the necessary extension fee and notification to the Department of the consent of the bonding agent.*
- (b) *Fee for extension.*
- (1) *A fee in the amount of twenty-five percent (25%) of the original permit fee, but not less than Twenty-five Dollars (\$25.00), shall be charged for an extension of a valid permit (not to include road construction or haul road permits).*
- (2) *The fee for an extension of a road construction permit shall be twenty-five percent (25%) of the original permit fee. Where the percentage of completion of a road construction permit exceeds ninety percent (90%) as determined by the Department, the permit fee shall be a maximum of Seven Hundred Fifty Dollars (\$750.00).*

### **7.6.3 Changes to Approved Storm Drain/Stormwater Technical Plans**

Any revisions to approved Storm Drain or SWM Plans shall be submitted to DPIE for review and approval prior to construction. A revision fee will be assessed for each revision submission. Revisions must be coordinated and approved by other reviewing agencies as necessary. The revision submission must include previously approved plans and revised plans with changes highlighted on both these plans. See Chapter 3 for review fee information.

---

## Chapter 8 STORM DRAIN DESIGN CRITERIA

### 8.1 Storm Drain Design Plan Criteria

#### 8.1.1 Introduction

This chapter of the Design Manual outlines the acceptable methods, criteria, and guidelines for the design of storm drainage systems. Stormwater runoff is to either be collected and conveyed in closed conduit systems (inlets, manholes, and pipes) or open system (ditches, streams, culverts, and improved open channels). This chapter provides guidance on the required design and plan information provided to the County for approval and for the construction of the facilities. **Because proposed connections to existing systems may not allow all design criteria to be met, the design consultant may request a waiver with appropriate justification.**

Parts of this chapter were developed using information in the design manuals from Howard County and Montgomery County, Maryland.

#### 8.1.2 Ordinance and Authority

Under the Annotated Code of Maryland Article 24A 5(G) Prince George's County is granted the express powers to provide for the drainage of low lands. These powers are defined further in the Prince George's County Code, Subtitle 23 – Roads and Sidewalks, Subtitle 24 – Zoning, Subtitle 27 – Subdivisions, and Subtitle 32 - Water Quality Resources and Grading Code.

#### 8.1.3 Definitions

Closed Conduit Systems:	An underground drainage system generally consisting of pipes, inlets, and/or manholes.
Culvert:	A pipe or closed conduit permitting drainage to cross under an embankment or road. Generally, culverts will be of one continuous size, without intermediate structures that significantly affect the hydraulic grade line. It may also be round, elliptical, square, rectangular, or another shape.
Hydrology:	The estimation of the volume and rate of storm water runoff from precipitation data and other watershed parameters of statistical data.
Hydraulics:	The calculation of flow depths and velocities for pipe and open channel systems.



Open Channel Systems:	A drainage system consisting of swales, ditches, and channels.
Overland Flow:	Unconcentrated sheet flow over either vegetated or paved surfaces.
100-Yr. Overland Flow Path	A path that overland flow follows to allow safe passage of 100-year storm flow with at least 1 foot between the overflow elevation and any entry elevation and typically indicated with flow arrows.
Time of Concentration:	The time for runoff to travel from the most distant point hydraulically of a relatively homogeneous watershed to a point of interest.

## 8.2 Hydrologic Computations for Design Conveyance Systems

The storm drain system will be designed to safely convey the ultimate development 10-year storm discharge for the entire drainage area, except for sites with Christiana soil complexes, Marlboro Clay formations, and Howell soils. These soils have severe limitations for foundation development, according to the Prince George's County Soil Survey. Sites with Christiana, Howell, Marlboro Clay or other unsuitable/associated soil types will require the system to be designed for a 100-year storm.

### 8.2.1 Rational Method

Generally, the Rational Method will be used for the flow capacity for storm drain systems. The design of culvert crossings may use the Rational Method for drainage areas of fewer than 20 acres, either Rational Method, TR-55, or TR-20 may be used for drainage areas between 20 and 50 acres, and TR-55 or TR-20 must be used for drainage areas greater than 50 acres. Unless otherwise specified in this chapter or identified on the SDCP approval letter, the 10-year storm will be used as the basis for all storm drain conveyance systems. See Section 8.5 for road culvert/bridge design criteria.

The Rational method formula is:  $Q = CIA$ ;

Where:

Q = Quantity of storm water runoff (cfs)

C = Runoff coefficient

I = Rainfall intensity (inches per hour)

A = Tributary area (acres)

- A. Runoff Coefficient - In computing flow at any point under consideration, the runoff coefficient shall be a composite of the ultimate development

“C” factors for all areas tributary to the point of study. “C” factors for development shall represent a weighted average based upon the proportion of the surface area covered by impervious materials, lawns, or woods. Table 8-1 explains the Rational Method Runoff Coefficient.

1. Composite “C” factors for typical developments are listed below and are the minimum for general use, unless computations are submitted showing a lower value. For projects with varied mixed land uses, the applicant is encouraged to calculate the composite “C”-value for each subarea.

**Table 8-1 Rational Method Runoff Coefficient**

<b>Zone/Development</b>	<b>7% or Less</b>	<b>Steeper Than 7%</b>
C Commercial (85% Imp.)	0.80	0.90
I Industrial	0.60-0.85	0.70-01.85
R-P-H Garden Type Apartments	0.60-0.85	0.70-0.85
R-H School, Churches	0.60-0.85	0.70-0.85
R-T Residential (65% Imp)	0.65	0.75
R-10 Apartments	0.60-0.85	0.70-0.85
R-20 Residential	0.60	0.70
R-30 Residential	0.60	0.70
R-35 Residential	0.60	0.70
R-55 Residential	0.55	0.65
R-80 Residential	0.50	0.60
1/3 Acre	0.45	0.55
R-R Rural Residential (25% Imp)	0.40	0.50
R-A Rural Agricultural	0.30	0.40
R-E Residential Estate	0.30	0.40
O-S Open Space	0.25	0.35

2. When composite “C” factors other than above are used, the “C” factors shall be computed using the following values:

---

Impervious areas	0.90
Lawns and grass areas	
Slopes 7% or flatter	0.25
Slopes greater than 7%	0.35
Wooded areas	0.20

### 8.2.1.2 Rational Method Correction Factor

A frequency of event correction factor,  $C_F$ , is used as a modifier to the Rational Method runoff coefficient. The intent of the correction factor is to compensate for the reduced effect of infiltration and other hydrologic abstractions during less frequent, higher intensity storms. The frequency of event correction factor,  $C_F$ , is multiplied by the runoff coefficient,  $C$ , to produce an adjusted runoff coefficient. Adjustment factors are summarized in Table 8-2.

**Table 8-2 Runoff Correction Factor**

Design Storm	Correction Factor
≤ 25-Year	1.00
25-Year	1.10
50-Year	1.20
100-Year	1.25

(Table from FHWA HEC-22)

## 8.2.2 Time of Concentration ( $T_C$ )

The  $T_C$  is the period of time required for the water to flow from the most hydrologic point within the tributary area to the point under consideration.

### 8.2.2.1 $T_C$ - Small Individual Drainage Areas

For most storm drain systems, pickup points as currently designed are located in a street, parking lot, or yard area. The need for calculating a  $T_C$  for each subarea can be time consuming and tedious. To reduce the requirement for individual calculations, the following  $T_C$  values may be used in lieu of individual calculations to each inlet or road culvert for drainage areas less than 2.0 acres. For non-residential areas, the overall project's percent impervious within the disturbed area will be used to establish the  $T_C$ . The following may be used for  $T_C$ .

Residential lots greater than 3,000 square feet	10 minutes
Residential lots less than 3,000 square feet	5 minutes
Commercial, Industrial, Apartments, or similar	5 minutes

### 8.2.2.2 $T_C$ - Large Drainage Areas

For storm drain systems intercepting more than 2 acres at any one inlet or headwall, the time of concentration may be calculated as defined in this section.

The following information has been substantially adapted from the *Maryland State Highway Administration (MSHA) Highway Drainage Manual*.

Since the design consultant may work with several storm frequencies, the Tc computation should be simplified by determining the Tc for the 10-year frequency storm and using this time for all frequencies. In the case of homogeneous drainage areas, the Tc will be the total time required for the runoff to flow from the most hydraulically remote point in the drainage area to the point of investigation (POI).

The same method applies to heterogeneous drainage areas that have higher "CA" product (runoff coefficient C x drainage area A) in the most distant portions of the drainage area. However, in the case of heterogeneous drainage areas where the most distant portions have a lower "CA" product than the portions nearest the POI, that may not be valid. In this case, maximum flow may occur before runoff from the most distant portions of the drainage area has reached the POI. When this occurs, both the Tc and the drainage area should be reduced to reflect this condition. The flow path should be carefully selected to be representative of the drainage area.

For example, panhandle-shaped drainage areas may yield extremely long Tcs that are not typical for the drainage areas. The same is true if a small wooded or grass area is used, when the sub-area is 90% impervious. Therefore, more than one path must be investigated when homogeneous areas are not present.

The Tc is the sum of overland flow (To), swale flows (Ts), ditch flow (Td), gutter flow (Tg), channel flow (Tch), and pipe flow (Tp) in the following formula:

$$T_c = T_o + T_s + T_d + T_g + T_{ch} + T_p$$

In most cases, several of the incremental time components will not be applicable. The following criteria will be used to derive the components of the Tc:

Overland Flow (To) - The total length of overland flow should not exceed 400 feet except over paved areas. It is assumed that within this distance some form of concentrated flow will occur. The surface roughness coefficients and maximum allowable flow lengths are obtained from MSHA Chart 61.1-402.0 and (To) is read from the nomograph MSHA-61.1-402.1. See Appendix 8-2.

Swale Flow (Ts) - Swale flow time shall be determined using Manning's equation. See Appendices 8-3 and 8-4

- for the nomographs, which are also MSHA Charts 61.1-402.3 and 4.
- Ditch Flow (Td) - Ditch flow time shall be determined using the Manning's Equation. See Appendices 8-5 and 8-6 for the nomographs, which are also MSHA Charts 61.1-402.5 and 6.
- Gutter (Tg) - Gutter flow times shall be calculated and verified against MSHA Chart 61.1 - 402.7. See Appendix 8-7.
- Channel Flow(Tch) - Channel flow times in streams shall be determined using Manning's equation with flow at top of bank.
- Pipe Flow (Tp) - Pipe flow time shall be calculated using the Manning's Equation for full flow depth.

For Ts and Td this is a trial and error procedure as follows: (refer to Table 1)

Tc @ point A is known

Assume an average velocity, V, in the ditch or swale and calculate Tc @ point B.

Use this time to compute the discharge in the ditch. Using the appropriate chart, read the instantaneous velocity  $V_i$ . Calculate the average velocity  $V_A$  by using 75% of  $V_i$ . If  $V_A = V$ , the assumption is correct. Continue on to the next section.

If  $V_A \neq V$ , use  $V_A$  as the next assumption. Continue this process until  $V_A = V$ .

The work of computing an estimated Tc through existing swales and ditches and along curb and gutter sections can be shortened with little loss of accuracy by using MSHA Charts 61.1-402.3 through 402.7 to determine approximate average velocity. Generally, swales shall be V-shaped or have a bottom width of less than 2 feet with side slopes between 2:1 and 4:1. Whereas ditches are defined as trapezoidal-shaped cross sections and have a bottom width of 2 feet or greater with side slopes 3:1 or flatter. The naming conventions of swales versus ditch are different between MSHA and MDE. In effect, MDE water quality swales are the equivalent of the MSHA criteria for ditches. Therefore, if an MDE swale (M-8) for ESD<sub>v</sub> is used, the MSHA criteria for ditches shall be used for Tc and velocity calculations.

The two swale flowcharts have a Manning's "n" value appropriate for either grass (n=0.06) or paved (n=0.015) linings. The MSHA swale design

criteria may NOT be used as part of ESD sizing criteria, since they do not meet the minimum bottom width criteria of at least 2 feet. To determine the average velocity for a swale, the following procedure will be used:

1. Determine the drainage area for overland flow to the top of the swale, ( $A_o$ ) and the corresponding runoff coefficient ( $C_o$ ).
2. Determine the additional area, which will drain laterally into this swale between the top and bottom of its reach, ( $A_s$ ), and its corresponding runoff coefficient ( $C_s$ ).
3. The average AC product in this reach will then be  $(A_o C_o) + 1/2(A_s C_s)$ .
4. Using the time at the top of the swale reach (which is also the overland time) find  $i_5$ .
5. Compute  $Q_5 = i_5 [A_o C_o + 1/2 (A_s C_s)]$ .
6. Compute the average slope of the swale reach and enter MSHA Charts 61-1-402.3, or 402.4 with this slope  $Q_5$ . Read the average velocity.
7. Divide the length of the swale reach by the average velocity to determine the flow time in the swale reach, ( $T_s$ ).
8.  $T_c$  to the bottom of the swale reach is then  $T_o + T_s$ .

Two ditch flowcharts have Manning “n” values appropriate for either grass ( $n=0.04$ ) or paved ( $n=0.015$ ) linings based on a 10-year storm. The velocity and depth for the 10-year storm shall use the “n” value of 0.04 to be consistent with MSHA criteria and not the MDE value. Table 8-3 shows recommended n” values for use with Chart MSHA-61.1-402.1.

If the “ditch” is used as an ESD device, both the 1- and 10-year storms will use a value of 0.15. The velocity will be determined for the 1-year storm to verify the velocity is less than 1 foot per second (fps). The “n” value for ESD “swale” was obtained from *2000 Maryland Stormwater Design Manual, Volumes I and II (MDE, 2000 and 2009)* (State Manual).

The following steps shall be followed.

1. Determine the additional area that will drain laterally into this ditch between the top and bottom of its reach ( $A_d$ ) and its corresponding runoff coefficient ( $C_d$ ).

2. The average AC product in this reach will then be  $(A_oC_o) + (A_sC_s) + \frac{1}{2} (A_dC_d)$ .
3. Using the time at the top of the ditch reach (which is also the overland and swale flow time) find  $i_5$ .
4. Compute  $Q_5 = i_5 [A_oC_o + (A_sC_s) + \frac{1}{2} (A_dC_d)]$
5. Compute the average slope for the ditch reach and then use MSHA Charts 61-1-402.5, or 402.6 with this slope and  $Q_5$  and read the average velocity.

**Table 8-3 Recommended “n” Values for Use with Chart MSHA-61.1-402.1**

**Avg. “N” Values for Rural and Natural Areas Type Of Surface “n”**

Cultivated Fields	0.30
Pasture or Average Grass	0.40
Woods	0.50

**Paved and Developed Areas Type of Surface “n”**

Paved Surface	0.02
Commercial or Industrial Development	0.05
Across average highway pavement and shoulder to surface ditch	0.10

The entire overland sheet flow time must be determined by a single computation. It can be computed in segments. If more than one type of surface is involved in the flow path, compute a weighted “n” proportional to the length of flow over each surface.

**OVERLAND FLOW LENGTH**

1. On erodible surfaces, the maximum allowable overland flow length is 400 feet. However, the design consultant should consider slope and soil type before defining the overland flow length.
2. On non-erodible surfaces, there is no limit on overland flow length, as it is determined from contours alone. Overland flow must never be continued beyond the point at which plans or contours indicate the presence of gutter, swale, or other watercourse.

The method outlined above is intended to save work in determining the  $T_c$  to the POI, and no attempt should be made to use the above charts as a substitute for Manning’s charts when designing ditches or swales or evaluating their operation, since they will not supply instantaneous velocity or depth of flow.



### 8.2.3 Rainfall Intensity

Rainfall intensity for the Rational Method shall be determined from the rainfall intensity curves table in Appendix 8-8. The intensity curves were developed for Tcs of 5 minutes to 1 hour for storm frequencies of 1, 2, 5, 10, 50, and 100 years. They were developed using the latest version of NOAA Atlas 14 and may be obtained from this website.

[NOAA Atlas 14 Precipitation Frequency Estimates for Maryland](#)

Using the computed Tc, the intensity can be determined from the Rainfall Intensity Chart. The “I” depends upon the time of concentration and the storm frequency used.

### 8.2.4 NRCS Method

The NRCS method of calculating hydrologic flow rates will be used for open channel designs and road crossing culverts with a drainage area exceeding 50 acres and for all bridges. The Windows version of TR-20 or 55 will be used and the software may be obtained from the following website.

[NRCS Hydrology & Hydraulics Tools](#)

The following criteria must be observed when using TR-55 or TR-20:

- A. Sheet flow lengths of 100 feet or less must be used. The maximum value permitted for a developed site is 0.22 hour with a 2-year rainfall amount and dense grass with a slope of 3% or less. The slope of 3% must be verifiable and shall be based on proposed grading.
- B. The most hydrologically representative travel path shall be used. For example, if the site is greater than 80% impervious, do not use 100 feet of sheet flow with grass, as this is not representative of actual site conditions. This may require the investigation of more than one travel path.
- C. When a total Tc of less than 6 minutes (0.1 hours) is determined, the 6-minute duration (0.1 hours) will be used.
- D. When computing the travel time for sheet flow, use 24-hour rainfall for the 2-year storm of 3.19 inches. The maximum “n” value that may be used is 0.40. For purposes of a 100-year floodplain study, the 24-hour rainfall for the 100-year storm will be used. See Prince George’s Soil Conservation District *Pond Safety Reference Manual*, page II-19, for rainfall amounts to use with the NRCS method.

[PGSCD Reference Manual](#)

- E. After short distances of at most 100 feet, sheet flow tends to concentrate in rills and then gullies of increasing proportions. Such flow is usually referred to as shallow concentrated flow. The velocity of such flow can be estimated using the general equations outlined in TR-55 for unpaved or paved flow path.:

$$V = 16.1345 S \text{ (Unpaved)} \quad \text{Eq. 8-1}$$

$$V = 20.3282 S \text{ (Paved)} \quad \text{Eq. 8-2}$$

Where:

V = Average Velocity (fps)

S = Slope of the Hydraulic Grade Line (watercourse slope ft/ft)

The nomograph from the Urban Hydrology for Small Watersheds, TR-55 (dated June 1986) named "Average Velocity for Shallow Channel Flow" utilizes equations 8-1 and 8-2 and is still applicable.

- F. Runoff curve number computations must be provided along with a soil group and Master Plan land use shown on a drainage area map.

[Prince George's County Soil Survey](#)

- G. Indicate on TR-55 or TR-20 output, the 10- and 100-year peak discharges at all study points.

### 8.3 Storm Drainage Conveyance Criteria

#### 8.3.1 General

Storm drain plans shall clearly show all storm drain construction details, street paving and other improvements, existing or approved storm drains, sanitary sewers, water mains, water and sewer house connections, gas mains, conduits or other utilities, streams, limits of wetland, floodplain, property lines, easements, rights-of-way, property ownership where applicable, and other pertinent data necessary for review or construction.

#### 8.3.2 Utilities

- A. Miss Utility- It is imperative the applicant or test pit contractor notify Miss Utility at 1 (800) 257-7777 at least 48 hours (a minimum of 2 working days) prior to beginning excavation to determine the location of existing utilities.

### Miss Utility

The design consultant should be familiar with Miss Utility Regulations associated with the Maryland Underground Facilities Damage Prevention Law (§12-101), which includes (but is not limited to):

1. According to the Maryland Underground Facilities Damage Prevention Law (effective October 1, 2010), Licensed Architects, Professional Engineers, Professional Land Surveyors, and Landscape Architects will be able to process designer tickets for projects in the planning phase. Owner members will have 15 full business days to respond to designer tickets.
2. An 18-inch “no mechanized equipment” zone is the statewide requirement for excavations or demolitions.
3. The complete law is available for review from the State of Maryland.

### Maryland State Law for Miss Utility

#### B. Utility Coordination

1. The design consultant shall coordinate the storm drain design with existing and proposed water, sewer, and all other utilities to ensure that there are no conflicts. Identifying utilities that may be encountered during design and/or construction will provide a better design and aid in reducing delays during construction if unknown utilities are encountered. The location of existing, proposed, and future water, sewer, and all other utilities are to be shown on the design plan and the crossings on the profiles. Sewer and water house connections shall also be shown on the plan and profile view, to verify there is no conflict, whenever they cross storm drain pipes .
2. The design consultant shall be responsible for obtaining the locations of all existing utilities and physical features through field surveys and current available records or by obtaining precise locations by test pits or other methods wherever exact locations of underground utilities are critical to the design, or where adjustment during construction would be required.
3. The design consultant shall be responsible for the research, collection, and collation of pertinent data on all proposed utility construction projects, which may impact the drainage design. The design consultant will be responsible for obtaining precise locations by test pits wherever exact locations of underground

utilities are critical to the storm drain design, or where adjustment during construction would be costly and/or cause significant delay. The design consultant shall coordinate this data in the development of the design drawings and specifications to avoid conflicts.

C. Utility Relocation and Protection

The design consultant is responsible for the design of relocation and/or protection measures for utilities. Utility verification plans should be coordinated with the various utility companies. At a minimum, the utility verification plans contain all identified existing utilities and utilities proposed for construction (if available) in the area. Upon receipt of verification plans, the design consultant shall update the utilities for subsequent design submissions. The following design criteria shall be considered.

1. All proposed and existing utilities crossing the storm drain system shall be shown to scale on the plan view and profile sheets.
2. A minimum vertical clearance of 12 inches and a horizontal clearance of 5 feet, outside wall-to-wall of pipes or structures, shall be provided between the outside of storm drain pipe or structures and the outside of other utilities including utility pole support cables. Exceptions may be granted on a case-by-case basis when justified.
3. The horizontal angle between storm drain and other utilities at crossings should generally not be less than 45 degrees. For new systems, additional manhole or inlet structures may be necessary to avoid existing utility conflicts.
4. When the storm drain outfall is in the proximity of underground utilities, additional riprap protection extending across the utility easement may be required. In some instances, storm drain pipe extensions crossing water and sewer lines may be required by WSSC. The design of such systems for crossing a water or sewer line will follow WSSC criteria.
5. Protection shall be provided where concentrated storm water flows across the trench of other existing utilities. Trench widths equivalent to the County's DPW&T standards shall be provided unless otherwise noted by the utility company.

### 8.3.3 Closed System Design Criteria

This criterion applies to any project with a closed section road (curb and gutter) and open section roads once the water is collected at an inlet. In general, storm drain design capacity is designated to be sized for a 10-year storm event.

#### A. Manning's Equation

The design consultant shall use Manning's equation to design the conveyance system.

$$Q = (1.486/n)(AR^{2/3}S^{1/2})$$

Where: Q = quantity of storm water runoff (cfs)

n = roughness coefficient (based on wetted perimeter)

A = cross-sectional area of flow (square feet)

R = hydraulic radius (feet)

S = friction slope Acceptable pipe material for storm drain/culvert systems is listed in Appendix 8-9. This list was developed from the DPW&T Standards and Specifications for Roadways and Bridges ("Standards and Specifications") as Table I-10. The information from DPW&T Table I-10 has been revised to prohibit the use of Corrugated Metal Pipe in the public right-of-way.

#### B. Table 8-4 provides standard nomenclature for labeling existing or proposed storm drain pipe material.

**Table 8-4 Pipe Material Type and Abbreviations**

<b>Abbreviation</b>	<b>Material Type</b>
APP	Aluminum Plate Pipe
APPA	Aluminum Plate Pipe Arch
ASRP	Aluminum Spiral Rib Pipe
CAP	Corrugated Aluminum Pipe
CAPA	Corrugated Aluminum Pipe Arch
CMP	Corrugated Metal Pipe
CMPA	Corrugated Metal Pipe Arch
CPP-D	Corrugated Polyethylene Pipe (Smooth Interior and Exterior)
CPP-S	Corrugated Polyethylene Pipe (Smooth Interior)
DIP	Ductile Iron Pipe
FCP	Fiber-Cement Pipe (Non-Asbestos)

HDPE	High Density Polyethylene Pipe
HERCP	Horizontal Elliptical Reinforced Concrete Pipe
PVC	Polyvinyl Chloride
PVWP	Polyvinyl Chloride Profile Wall Pipe
RCP	Reinforced Concrete Pipe
RCPD	Reinforced Concrete Pressure Pipe
SPP	Structural Plate Pipe
SPPA	Structural Plate Pipe Arch
SRP	Spiral Rib Pipe
VERCP	Vertical Elliptical Reinforced Concrete Pipe

D. Roughness Coefficient (n)

The roughness coefficient obtained from the *Highway Drainage Manual* shall be used as follows in Table 8-5 for the various pipe materials:

**Table 8-5 Manning’s Roughness Coefficients for Pipe**

Concrete Pipe and Precast Culverts	0.013
Monolithic Concrete Box Culvert	0.015
Corrugated Metal Pipe (2 2/3 x 1/2 annular corrugations)	0.025
Corrugated Metal Pipe (3 x1 annular corrugations)	0.028
Corrugated Metal Pipe (2 2/3 x 1/2 helical corrugations)* 15" to 36"	0.019
42" and larger	0.014
Corrugated Metal Pipe (3x1 helical corrugations)* 36" to 84"	0.021
96" or Larger	0.024
Smooth walled CMP	0.013
Corrugated HDPE	See CMP
PVC or HDPE	0.011
Corrugated metal pipes 25%	0.021

paved invert full flow	
Corrugated metal pipes 40% paved invert full flow	0.020

\*Limitations - Since the low values depend upon the development of spiral flow across the entire cross section of helical corrugated pipe, the design consultant must verify that a fully developed spiral can occur for the design condition. It is recommended that the “n” values for helical pipe be used under the following conditions:

1. Partly full flow in the pipe
2. Extremely high sediment load
3. Short culverts less than 20 “ diameters
4. Non-circular pipes
5. Partially paved pipes

Where drainage systems are composed of more than one of the above-mentioned materials, a composite roughness coefficient must be determined in proportion to the wetted perimeter of the different materials.

**8.3.3.1 Design Considerations**

Design plans shall clearly show pipe size, material, and other information to define what is to be constructed. Some considerations for the design of underground piping systems are as follows.

1. All public main line storm drain pipes will be reinforced concrete with rubber gaskets, reinforced elliptical concrete pipe, reinforced concrete box culvert, or reinforced concrete arch pipe, unless otherwise specified and approved by DPIE or DPW&T. All concrete pipe shall be at least class IV or equivalent within the public right-of-way and to the first structure outside of the public right -of-way or the paving section of private roads for single family attached or detached fee simple lots. ESD pipes or diversion pipes to SWM facilities may be PVC or HDPE.
2. Only RCP may be used for public road driveway culverts.

3. For private storm drain pipe systems, CMP, HDPE, or other material deemed acceptable by DPIE or DPW&T for public systems may be used. This includes private storm drain systems in projects such as apartment, condominiums, commercial, retail, or industrial zoned properties. The private systems are to be maintained by the property owner.
4. CMP shall have a minimum gauge of 14 and the gauge shall be noted in the pipe schedule. Pipe certificates and markings shall indicate pipe gauge.
5. HDPE smooth interior pipe shall have connections limited to bell-and spigot or bell/bell couplings with gaskets. Couplings shall be interchangeable with different manufacturers' pipe and be capable of providing a satisfactory connection.
6. All HDPE pipes shall terminate in a concrete headwall/end wall or storm drain structure such as a manhole or inlet, or control structure. Underground SWM pipe connections and manholes may be other materials.
7. The minimum inside pipe dimension to be used for public storm drainage system shall be 15 inches or the equivalent for elliptical or pipe-arch pipe. This does not apply to water quality control feeder pipes, underdrains, inverted elbow pipes, SWM low flow diversions, and ESD device diversion.
8. For private storm drain systems, a minimum pipe size of 15 inches is required, except that 12 inches is acceptable for the first run of pipe only. This requirement excludes the extension of roof drains and other minor landscape or hardscape drain systems that are less than 12 inches in diameter.
9. The minimum size of the roof drains and other minor drainage systems that connect to the storm drain system shall be 4 inches for private and 6 inches for public all at 1% minimum slope. In certain non-structural storm water management applications such as flow splitters, observation wells, underdrains, etc., the minimum diameter of the pipe may be less than 6 inches.
10. Pipe sizes may be reduced a maximum of one size for the system in the direction of flow, provided that the flow capacity is not compromised and does not result in surcharges.
11. Installation of all pipes shall conform to current County specifications as contained in the Specifications and Standards and the *Prince George's County Department of Environmental (DOE)*



*Standard Details for Stormwater Management Construction or subsequent County issued details or modifications herein.*

12. Wherever practicable, existing natural drainage-ways shall be preserved as a supplementary element to closed drainage systems. In all cases, closed systems shall discharge into existing natural drainage-ways as soon as practicable.
13. Where closed drainage systems are not essential to protecting property or serving portions of development dedicated to permanent open space, the use of existing natural or open ditch drainage-way systems are encouraged. In some cases, it may be preferable to implement stream restoration for portions of degraded natural channels rather than enclose in a storm drainage conveyance system.
14. Full consideration shall be given to future extensions of the storm drain system including possible future easement requirements. For required extensions, it is the applicant’s responsibility to acquire any off-site easements for drainage purposes.
15. Computations are summarized in the Pipe Sizing Form in Appendix 8-10.
16. Table 8-6 depicts standard elliptical pipe sizes and the circular pipe size with the approximately same cross sectional area.

**Table 8-6 Elliptical Pipe versus Circular Pipe Equivalencies**

<b>Elliptical Span x Rise Inches</b>	<b>Area sq. ft.</b>	<b>Circular Diameter Inches</b>	<b>Area sq. ft.</b>
		15	1.23
23 x 14	1.8	18	1.77
		21	2.41
30 x 19	4.1	24	3.14
34 x 22	5.1	27	3.98
38 x 24	6.3	30	4.91
42 x 27	7.4	33	5.94
45 x 29	8.8	36	7.07
53 x 34	10.2	42	9.62
60 x 38	12.9	48	12.57
68 x 43	16.6	54	15.9
76 x 48	20.5	60	19.63

### 8.3.3.2 Plan Design

In addition to pipe size and material, a number of design decisions are required for the location of the storm drain pipe. The following provides some guidance to the design consultant.

1. The horizontal alignment of the pipes shall be straight lines for all public systems between access points, and a maximum of 90-degree turn except as follows:
  - a. Within a structure, if the incoming pipe is less than or equal to 1/2 of the diameter of the outgoing pipe and the invert is at least 1 foot with at least 3 inches of concrete between the precast openings above the outgoing pipe crown, there is no limitation on the angle.

2. Publicly maintained systems may not have any curvature unless existing conditions preclude alternate alignment. Typically, the designer must propose new structures to allow for straight line pipe installation.

For private systems, pipes 30 inches in diameter and larger may be curved horizontally and vertically. The joint opening is not to exceed 1/3 of the length of the tongue, and a note to that effect is to be shown on the plan. All pertinent data are to be shown on the plan; (i.e., radius, chord, tangent, and curve length, PC, PT, and PI).

3. Field connections into the main line pipe of a public system are not acceptable. Only connections with manholes may be used. The exception is a roof drain or sump pump extension connection to the public storm drain system, which is permitted under the Special Drain Permit. The preference is to first connect to a structure, before approval of a connection to the pipe will be approved.
4. Field connections for private systems may be used only when the main line pipe involved is 15 inches in diameter or greater (Except for Special Drain Permit connections) and the receiving pipe shall be at least twice the diameter of the incoming pipe. Whenever possible, the branch line should enter the main line at an angle less than 90 degrees in the direction of flow. The pipe shall not extend into the inside of the receiving pipe and shall be trimmed to match the wall of the receiving pipe.
5. A storm drain pipe parallel to property lines may not be located along the property line. Provide a minimum 2-foot offset from the property line from the outside face of the storm drain pipe for

- such purposes. No privately owned fencing will be permitted in the storm drain easement.
6. Generally storm drain pipe should be centered in the easement. In cases where offsetting the pipe alignment within the easement augments future maintenance accessibility, offsetting may be allowed on a case-by-case basis. An example would include an outfall discharge area on common property or in steep slope conditions.
  7. An adequate and safe overflow path for the 100-year storm is to be shown on the plan view even if the path is directly over the pipe. Where applicable, proposed grading shall ensure that overflow will be directed to attenuation facilities designed to control the 100-year storm. A detailed cross section of overflow path and delineation of flow boundaries may be required where possible building flooding could result. Adjacent buildings must have at least 1 foot of freeboard for the 100-year storm at the lowest opening elevation.
  8. The outside of pipes or structures shall be a minimum of 5 feet horizontal from outside of other utilities, pipes, or structures.
  9. A headwall shall be located at least 5 feet beyond the subject site property line or public utility easement and as necessary to provide a 3:1 surface grade from the top of the headwall to the property line, whichever is greater. See Section 5.2.4.4.2 for additional information.
  10. A driveway culvert for standard rural sections roads within a public right-of-way must be built with concrete end walls. Stone facing, CMP, or other materials for an end wall or end sections are allowed for private driveways.
  11. A cutoff wall may only be used when a future extension of the system is anticipated within a later project phase. It will not be acceptable to terminate a system as the last structure on the project.
  12. A standard end wall/headwall will be used when there is no foreseeable future extension of the storm drain pipe.
  13. A flared end section may be used for public systems with a pipe that has a diameter of 24 inches or less, if the skew is less than 60 degrees to the normal, and if there is no constant flow. The outfall shall meet the location requirements from Section 8.3.3.2.9 above, except for driveway culverts. The end section or headwall for a

driveway culvert in a public right-of-way shall be located at least 5 feet from the paved edge of driveway.

14. The underdrains for curb and gutter do not need to be shown on the plan view of the design drawings. They will be noted on the profile and the structure schedule, to indicate elevation and entry side of structure. See Appendix 8-11 for one example of a structure schedule that could be used. All other underdrains shown in SWM or ESD facilities or the public right-of-way must be shown on the plan view and in the pipe schedule.
15. When parallel pipes are provided, the dimension between the outside of the pipes shall be 2 feet, or 1/2 the diameter of the pipe, whichever is greater.

### 8.3.3.3 Profile Design

In Prince George's County, storm drain profiles have several primary purposes. First, they verify that minimum cover is obtained over the top of the pipe to final grade; second, identify any existing or proposed utility crossings so minimum clearances are maintained; and lastly, they identify the type of material and lengths of pipe reaches. The following are additional considerations for the preparation of profiles.

1. All RCP pipes are to be provided with 1-foot minimum cover in open space areas. When the pipe passes underneath bituminous pavement, a minimum of 9 inches of clearance measured from the outside of the pipe to the bottom of the asphalt paving section gravel sub-base is required for public streets, driveways, parking lots, or other paved areas traversed by vehicles. For driveways or sidewalks, 8 inches below sub-grade is acceptable.
2. Where necessary, a note on the profile may be required to ensure a 1-foot minimum cover over the outside of the pipe material. When within 5 horizontal feet of a tree in the public right-of-way, provide at least 4.5 inches from ground to top of pipe.
3. A pipe loading chart for American Society for Testing and Materials (ASTM) C-76 RCP (Appendix 8-12) has been included to guide the design consultant in confirming if additional design considerations are necessary. For pipe types and sizes not included in the loading chart, design computations are to be submitted for review and approval prior to manufacturing and storm drain permit issuance.
4. All flexible pipes (CMP, HDPE, PVC, etc.) shall have a minimum cover of 2 feet measured from the ground, top of concrete, or bottom of asphalt paving sub-base. A bedding detail shall be

provided on the plan. In all cases, the pipe manufacturer’s recommended cover will be considered the minimum requirement if more than 2 feet.

- 5. Plans shall provide a minimum of 12 inches of vertical clearance between the outside of the storm drain pipe and the outside of any utility structure, pipe, or conduit, or as approved by the affected utility company.
- 6. The minimum velocity for a 10-year storm in a public storm drain pipe shall be 3.0 fps, where possible. This does not apply to a 15-inch RCP for the first reach of a system. Lower velocities will require the approval of the DPIE. These pipe sizes shall have minimum flow rates as noted:

15" RCP	Minimum flow rate 0.45 cfs
18" RCP	Minimum flow rate 0.5 cfs
21" RCP	Minimum flow rate 0.55 cfs
24" RCP	Minimum flow rate (with slope 0.5%) 1.2 cfs.

If less than the minimum slope is used, provide documentation that 3 fps is achieved.

- 7. To enhance self-cleaning characteristics, all pipes less than 24 inches in diameter shall not be laid on less than a 1% slope. The minimum slope for pipes 24 inches in diameter or larger shall be 0.5% unless approved as an exception from the County. Any exceptions will require maintaining the minimum velocity of 3 fps for the 10-year storm.
- 8. When a pipe is designed on a slope greater than 20%, pipe anchors are required. See DER SD 100.0. The station and location of the pipe anchorages must be shown on the pipe profile.
- 9. At inlets, manholes, etc., the invert of the pipes upgrade shall be a minimum of 0.1 foot above the inverts of the outgoing pipe. In cases where the pipe size changes, the crown of the upstream pipe shall be no lower than the crown of the downstream pipe, unless there are conflicts with existing utilities.
- 10. All manholes and inlets, except terminal inlets, shall have a brick lined flow channel, unless concrete bottom is required. A concrete flow channel is not acceptable.
- 11. Where the drop in the main line through a storm drain structure or a secondary incoming storm drain pipe is greater than 2 feet, the bottom of the structure will be lined with concrete at least 4 inches thick. No shaped channel will be required for this

- construction however; the bottom of the structure shall slope at least 1/2 inch per foot toward the invert of the outlet pipe.
12. The maximum ponding depth at a low point in a yard or street prior to any overflow elevation shall be 2 feet.
  13. If the overflow will pass over a Marlboro Clay area, an associated conveyance system shall be designed for the 100-year storm flow with the discharge point located outside of Marlboro Clay.
  14. For storm drain systems that outfall into a retention pond, the outfall invert generally shall be no lower than the permanent pool WSEL. For outfalls with extremely flat slopes, the invert of the pipe may be located a maximum of 2 feet or 1/2 the pipe diameter, whichever is less, below the permanent pool. In no case shall the incoming pipe invert be less than 1 foot above the bottom of the pond. For storm drain systems that outfall into a forebay, the outfall invert shall be no lower than the forebay normal WSEL.
  15. A 4-foot high fence shall be provided on a headwall or the temporary cutoff wall structures (for onsite projects only), when the storm drain pipe is 24 inches or larger. For flared end sections or end walls in the public right-of-way, when the pipe size exceeds 24 inches, they shall be evaluated on a case-by-case basis. The fence shall be anchored to the structure by using non-shrink grout (See DER SD 40.0).
  16. For all HDPE or CMP pipe, rubber gaskets shall be provided in accordance with the manufacturers' specifications.
  17. Summarize pipe size, length, material, and pipe class or gauge similar to the example pipe schedule in Appendix 8-13. The design plan pipe schedule does not need to match the example in the appendix, but must contain the minimum information. All pipe in water quality devices, including smaller pipes such as underdrains, shall be included in the pipe schedule and shall be accounted for in the review fee.

#### 8.3.4 Hydraulic Gradient

The method of calculating structure loss has been adapted from the MSHA "Highway Drainage Manual." Closed conduit design shall be based on the hydraulic grade line method, with pipes assumed to be flowing full. In some cases for flat or existing systems, the hydraulic grade line may use the actual depth of flow in the pipe. The losses are applied at the structures.

**A. Beginning Elevation**

The hydraulic gradient shall be determined starting at the downstream end of the proposed drainage system. When a free outfall is expected, new systems must be designed by beginning the hydraulic gradient at the outfall at the downstream WSEL for the 10-year storm or the crown of the pipe, whichever is higher.

For systems without free outfalls, the hydraulic gradient should be started with an estimated or (when possible) the computed tail water elevation or the crown of pipe, whichever is higher.

When the proposed storm drain discharges into an existing storm drain system, the beginning elevation for the hydraulic gradient can be determined as follows:

1. If sufficient data is available, calculate the hydraulic gradient through the existing system and extend it through to the proposed system.
2. If the hydraulic gradient in the existing system is not easily determined because of the extensive downstream system, select the highest structure in the existing downstream system, which will surcharge through the inlet throat or grate. Assume a flooding condition at this structure; i.e., start the hydraulic gradient at this structure using the grate or throat opening elevation plus an additional amount of surcharge up to 2 feet based on discussions with the County to account for the downstream complexities, as the beginning hydraulic gradient elevation.

**B. Pipe and Structure Losses**

1. After determining the beginning elevation,  $E_1$ , calculate the head loss,  $H_F$ , due to friction in the pipe from point 1 to point 2 or the crown of the pipe, whichever is higher.

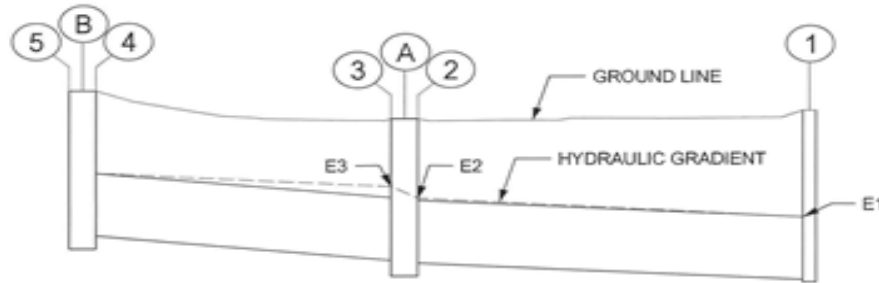

Figure 8-1 Hydraulic Grade Line Profile Example

$$H_F = S_F L \quad \text{Eq. 8-3}$$

Where:  $H_F$  = Head loss (in feet)

$S_F$  = Frictional slope of the pipe (in feet per foot)

NOTE: For standard use,  $S_F$  is determined by the slope of the pipe assuming it is flowing full.

For Outlet control, use the crown of pipe or tail water elevation in the stream, whichever is higher.

$L$  = Length of pipe between structures (in feet)

This head loss is added to the beginning elevation,  $E_1$ . This new elevation,  $E_2$ , is the hydraulic gradient at point 2. Now calculate the head loss due to structure A. The magnitude of the structure loss is dependent on the type of structure (i.e. inlet, manhole, or bend) and the angle between the incoming and outgoing pipes. It is computed by the following formula.

$$H_B = \frac{K_B V_F^2}{2g} \quad \text{Eq. 8-4}$$

Where:  $H_B$  = Head loss (in feet)



$K_B$  = Head loss coefficient (Appendix 8-14 which is also MSHA form 61.1 - 408.0)

$V_F$  = Frictional velocity in the outlet pipe (in feet per second) based on flowing full. The velocity for the given  $Q$  and  $d=h_o$ .

$g$  = Acceleration due to gravity (in feet per second, per second).

This loss may also be determined by the appropriate chart. The structure loss at a field connection is the same as that for a manhole.

The structure loss,  $H_B$ , is now added to the hydraulic gradient or crown of downstream pipe, whichever is higher. This elevation,  $E_3$ , is the new beginning elevation to compute the hydraulic gradient up to structure B. Repeat this procedure for the entire system.

The last structure at the top of a closed system (usually an inlet) shall be treated as a headwall and the headwater computed using FHWA Hydraulic Design Series Number 5 *Hydraulic Design of Highway Culverts* with the tail water equal to the higher of the hydraulic gradient or crown of pipe.

### [Hydraulic Design of Highway Culverts \(HDS No. 5\)](#)

#### 2. Junctions

When two pipes feed into one structure, the controlling angle is determined by the following method.

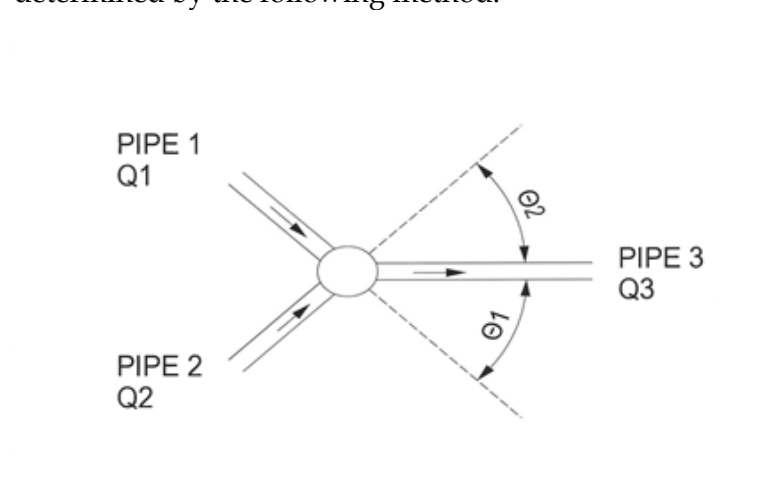

Figure 8-2 Pipe Angle Example

Using the 10-year frequency data (100-year for Marlboro Clay) from the storm drain design computations for the structure:

- Determine  $V_{1/3}$  the friction velocity of  $Q_1$  in pipe 3
- Determine  $V_{2/3}$  the friction velocity of  $Q_2$  in pipe 3
- With  $V_{1/3}$  and  $\Theta_1$  determine the structure loss  $H_1$
- With  $V_{2/3}$  and  $\Theta_2$  determine the structure loss  $H_2$
- If  $H_2$  is greater,  $\Theta_2$  is the controlling angle
- If  $H_1$  is greater,  $\Theta_1$  is the controlling angle

The controlling angle is used to calculate the loss in the structure. Determine the friction velocity of  $Q_3$  in pipe 3 and use the controlling angle for  $H_B$ , the head loss at that structure. See Appendix 8-15 for an example calculation and Appendix 8-16 for a sample form for determining structure loss.

### C. General Limitations

When the hydraulic gradient is being computed, the design consultant must have available either a profile of the system or a list of invert elevations and structure flooding elevations against which each computed hydraulic gradient elevation may be checked.

Each time a structure loss is computed and added to the hydraulic gradient, the resulting gradient elevation should be compared to the throat or grate elevation for the structure. Structures without surface access cannot flood and need not be checked. For street inlet structures, the 10-year storm hydraulic grade line (HGL) must be at least 1 foot below the top of grate, curb throat, or the bottom of curb. For yard inlets, the HGL must be 1 foot below the grate or slot opening, whichever is lower. In the event of a system that must be sized to convey the 100-year storm, the 100-year HGL shall not exceed the grate opening, inlet throat, or the top of manhole elevation of the system structures.

When the gradient exceeds the prescribed limits, two practical measures are available to reduce the gradient elevation without changing alignment and/or structure type:

1. Lower the system sufficiently to mitigate the HGL.
2. Increase the capacity of the pipe immediately below the flooding structure by increasing size or decreasing the roughness coefficient or when this is not sufficient, by use of multiple pipes.

When it is necessary to increase pipe size, care must be taken to avoid the creation of a future maintenance problem resulting from discharging a pipe of greater cross section into a pipe of lesser cross section. In no case may the upstream pipe diameter be greater than one size larger than the downstream pipe diameter. This is largely a trial and error procedure. If these measures are insufficient or impractical, the design consultant should investigate changing alignment in order to lower the gradient.

3. Where the friction slope is less than the actual slope of the pipe, the hydraulic grade line shall be at the crown of the pipe. DPIE will consider on a case-by-case basis if the partial flow elevation may be used in lieu of the crown to establish the HGL. The following procedure shall be used.
  - a. After computing the friction loss in a section of pipe and determining the hydraulic gradient elevation at the upstream end of that section, the design consultant should also compute the normal depth elevation at this point. When a pipe is flowing less than full (not under pressure) the elevation and the WSEL at any point are the same. This depth of flow is called the normal depth.
  - b. The normal depth elevation is the normal depth plus the invert elevation at that point. If the computed hydraulic gradient elevation is lower than the normal depth elevation, the gradient must also be adjusted to the normal depth elevation at that point.
4. When the sum of the hydraulic grade elevation into the inlet plus the structure loss is less than the crown elevation of the upstream pipe, the hydraulic grade elevation shall be shown at the upstream crown of the pipe.
5. A hydraulic gradient for the 10-year design storm shall be computed and plotted on the profile unless it is in a Marlboro Clay area, where the 100-year design storm shall be used. This gradient is to take into consideration friction losses in the pipe and channels, computed structure losses, and tail water conditions.
6. All enclosed systems shall be designed so that they will generally operate without building up a surcharged hydrostatic head under design flow conditions. The preference is to maintain a HGL to less than 1 foot over the crown of the pipe. Rubber gaskets meeting ASTM C-443 for round pipe is required for all pipe joints for ASTM C-76 concrete pipe regardless of amount of surcharge.

7. When the storm drainage system terminates at an upstream headwall or end section, the water surface at the headwall or end section shall be determined by computing the entrance condition for both inlet and outlet control conditions. See the website below or equivalent publication to FHWA Hydraulic Design Series Number 5 *Hydraulic Design of Highway Culverts* for more information on calculating the WSEL at headwalls.
  
8. **Concurrent Flood Analysis** - For the purpose of evaluating the tail water for the storm drain system, concurrent flood analysis may be used on a case-by-case basis so that ditches, channels, storm drains, and culverts are not oversized or undersized. Typically, a concurrent flood analysis is performed when there is a confluence of two watercourses. These confluences can include stream junctions with storm drain system discharges into a larger waterway.

The main stream area is considered to be the stream with the larger drainage area; whereas the tributary is the storm drain system. The area ratio in Table 8-7 is the ratio of the drainage areas for the main stream and tributary.

Once the drainage areas have been assessed and an area ratio determined, the design consultant shall round the calculated ratio down and develop the appropriate discharges to complete the HGL analysis.

**Table 8-7 Frequencies for Coincidental Occurrence**

Area Ratio	10-Year Design Main Stream	Tributary	100-Year Design Main Stream	Tributary
10,000:1	1	10	2	100
	10	1	100	2
1,000:1	2	10	10	100
	10	2	100	10
100:1	5	10	25	100
	10	5	100	25
10:1	10	10	50	100

	10	10	100	50
1:1	10	10	100	100
	10	10	100	100

**Note: Table from American Association of State Highway and Transportation Officials (AASHTO) Model Drainage Manual**

9. Friction Losses - Head loss due to friction ( $H_F$ ) in pipes with uniform flow shall be determined by the Manning’s Formula:

$$S_F = \frac{(nv)^2}{2.208r^{4/3}} \quad \text{Eq. 8-5}$$

$$H_F = S_F \times L$$

$S_F$  = the friction slope in ft. per ft. of drain.

For a pipe laid on a curve, “n” shall be increased by 0.001 for each 20 degrees of curvature. Curved alignments are only acceptable for private systems.

**8.3.5 Inlet and Manholes**

**A. Inlet Design Criteria**

1. Cast-in-place inlets at an intersection shall be placed a minimum of 3 feet from a curb fillet P.C. or P.T.
2. For precast structures, the distance between the inlet and the curb fillet shall be 4.5 feet from the inside face of an A-inlet. The end of a residential driveway apron flair shall be an additional foot away from the inside face of the inlet. A commercial driveway or handicap ramp does not require any additional spacing from the above dimensions, only an expansion joint.
3. At no time shall inlets be placed within the curb fillet.
4. In traffic lanes where grates are used, the grate must be bicycle safe.
5. Do not place in crosswalks or other locations that may impede pedestrian movement.
6. For grates that are located in sidewalks, crosswalks, or other areas of pedestrian pathways, the grate shall be compliant with the

Americans with Disabilities Act (ADA). This would not apply to grates in a parking lot unless the grate is in the pedestrian path.

- 7. Curb opening inlets or combination inlets shall be used where curbs are either existing or proposed. Curb opening inlets are preferred.
- 8. Depressed grate inlets shall not be used in traffic lanes.
- 9. Throat opening inlets and combination inlets may be used in sumps.

B. Inlet Spacing, Capacity, and Street Spread Criteria

- 1. Provide inlets at all sumps.
- 2. Inlets shall be installed upstream of intersections and commercial driveways if the 10-year flow is 3.0 cfs or greater.
- 3. The maximum flow across or around an intersection shall be 2 cfs.
- 4. All gutter and spread computations for the County standard road section are based on a cross slope of 2%. See Appendix 8-17 for graph.
- 5. Install inlet at intermediate points along public streets so the water spread is less than 10 feet.
- 6. When the cross-slope of the pavement is different from 2% and the gutter pan is the same slope as the road, capacity and spread shall be based on the following equation:

$$Q = 0.56 (Z/n)S^{1/2}y^{8/3} \qquad 8-5$$

Q = discharge in cfs

Z = the reciprocal of the pavement cross-slope or the side slope in ft. per ft. For example, for a cross-slope of 1/4 inch per foot or 2.08%, Z = 46

n = Manning's coefficient (normally 0.013 for concrete and 0.015 for asphalt pavement)

S = gutter slope in ft/ft

y = depth of flow in ft

- 7. Care shall be exercised when placing inlets near pedestrian ramps in curb section. Inlets shall be placed outside the transition slope for a pedestrian ramp.

8. At least 70% interception for the 10-year storm of gutter flow shall be collected at each inlet under ultimate development conditions. Inlet computations shall be in a tabulated form, showing the time of concentration, intensity, and flow to each inlet (including bypass from other inlets), length of inlet opening, slope of street, capacity of inlet, and bypass to other inlets. See Appendix 8-18 for example curb inlet interception charts, Appendix 8-19 for MSHA COG inlets, Appendix 8-20 for MSHA WR-inlets, and Appendix 8-20 for a summary table of inlet capacity.
9. Inlets not in paved travel ways may be yard inlets designed with either grate top or throat openings. The grade around the inlets shall match the top of structure for sides with no slots.
10. Unless otherwise approved by DPIE, no combination curb and grate inlets are acceptable for a public system.
11. For private systems, the maximum ponding depth of the 10-year flow at any inlet along a paved surface or curb and gutter shall not exceed 6 inches from the low point elevation.
12. Curb opening inlets located in sump areas must be "A" type inlets and have a maximum capacity of 6.75 cfs per 5 linear feet of throat opening and shall be designed to pick up 100% of the flow.
13. Curb inlets that are located in sump areas are to be provided with an additional 5 linear feet of opening in addition to width required to intercept the design flow.
14. **B inlets are no longer allowed in public storm drain systems. This decision has been made by the County because of numerous construction issues that have resulted in insufficient manhole steps and inadequate access into the structures.**
15. Sump inlets shall be designed with provisions for a safe overflow path so as not to cause damage to adjoining properties and 1 foot of freeboard to lowest opening elevation provided. Overflow arrows shall be shown on the plan view drawing.
16. A minimum slope of 2% across the intersection is required. If 2% is not feasible, provide a valley gutter with at least 1% slope.
17. A project with on-site private drainage systems may be connected to County-owned systems within the public streets or easement. The pipe and first structure beyond the public right-of-way shall be public. All connections to existing public conveyance systems shall require an access point of entry (e.g., manhole or inlet structure connection).

18. The maximum of 3 cfs of surface flow from any one discharge point from a private property to a public road shall be 3 cfs.
19. Maximum allowable spread of flow in a parking lot for commercial and industrial development shall be 15 feet. The 10-year flow runoff depth in the gutter shall not exceed 6 inches.
20. In calculating the spread within vertical curves, the actual grade between the point 25 feet prior to the inlet and the beginning of the inlet shall be critical to this determination, not the longitudinal tangent grade of the roadway.
21. deleted
22. Curb inlets located on cul-de-sacs shall have an opening of a maximum of 10 linear feet, and a safe overflow path.
23. If MSHA inlets are used, refer to the appropriate MSHA table in the latest version of the *Highway Drainage Manual* for determination of flow intercept. A minimum of 70% interception for the 10-year storm is required.
24. Grate-type inlets should be used only when design considerations preclude the use of standard curb opening inlets or when required by regulation. Grate inlets when placed within the clear zone or potential path of a bicycle shall utilize a bicycle safe grate that is HS-20 loading compliant. The bicycle safe grate requirement will be waived only on a case-by-case basis where it is determined that the inlet would not pose a hazard to bicyclists. Applicable styles of bicycle safe grates are as follows:
  - Reticulated
  - Curved Vane
  - Parallel Bar Grate



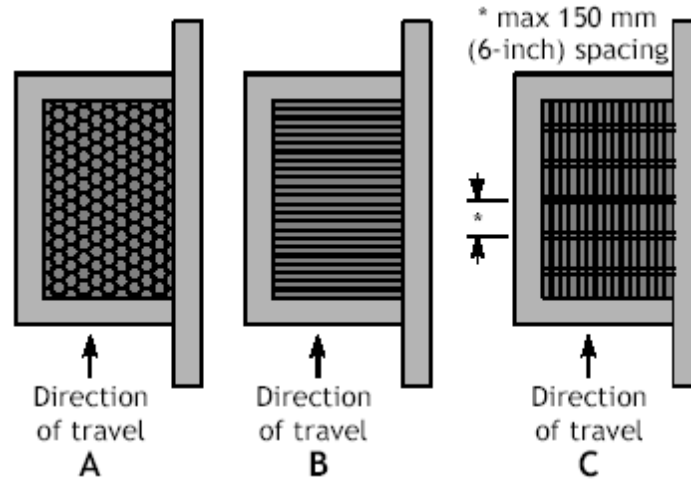

**Figure 8-3 Bicycle Safe Gate Options**

Source: Oregon Bicycle and Pedestrian Plan (1)

All grate inlets, unless otherwise approved by the County, shall utilize combination curb openings to act as a sweeper and prevent clogging of the inlets.

Grates in crosswalks and walkways shall be avoided where practicable; however, ADA specifications shall be met for inlets located within walkways. Based on a review of MSHA grates, the grates that meet the bicycle safe options are included in Table 8-8. When grates are approved for use, the designer shall review the following grates for applicability and use on the project.

**Table 8-8 MSHA Grates**

Category	Standard Number	Inlet Type	Description
Reticulated	MD 374.02		Standard WR & WRM Inlet
Reticulated	MD 374.12		Standard NR & NRM Inlet
ADA	MD 374.85-01		Standard "ADA" Compliant Single Inlet
ADA	MD 374.86-01		Standard "ADA" Compliant Double Inlet
Curved Vane	MD 376.12-01	E-CV	Curved Vane Grates
Curved Vane	MD 379.02-01	S-CV	Curved Vane Grates
Curved Vane	MD 379.05-01	S2-CV	Curved Vane Grates

- 25. In lieu of the street capacity charts, the U.S. Department of Transportation, FHWA, *Drainage of Highway Pavements*, HEC No. 12, FHWA-TS-84-2002, may be used, taking into consideration street grades, road cross slopes, gutter capacities, and permissible spread of surface flow.

C. Inlet Efficiency Computations

Computations shall be provided for all inlets within or that affect the County storm drain system. See Table 8-9 for a listing of Prince George’s County standard inlets. Inlet capacity charts and street spread charts shall be used to determine inlet opening sizes. These charts are included in Appendix 8.

**Table 8-9 DPIE Standard Inlets**

PGDER No.	Standard Inlet Type	Style
SD 10.0	Type A COS	Curb Opening ( Center Access)
SD 15.0	Yard Inlet	Terminal Inlet
SD 14.0	Type D	Yard Inlet
SD 16.0	Type E	Yard Inlet
SD 17.0	Type K	Ditch Inlet

For non-standard roadway conditions, such as non standard road cross slopes, the following equations may be used to size curb-opening inlets on a continuous grade:

The length of curb-opening inlet required for total interception of gutter flow on a pavement section with a straight cross slope is expressed by the following equation:

$$L_T = 0.6 * Q^{0.42} * S^{0.3} * (1/n * S_x)^{0.6} \tag{8-6}$$

Where:

$L_T$  = Curb Opening Length required to Intercept 100% of Flow (ft)

$S_x$  = Cross Slope of the Roadway (ft/ft)

$S$  = Longitudinal Gutter Slope (ft/ft)

$n$  = Manning's Roughness Coefficient

$Q$  = Design Discharge (cfs)

## 1. Composite Gutter and Curb Opening Inlet Interceptions

Where composite gutters are used, the designer will follow the methods outlined in FHWA *Hydraulic Engineering Circular No. 22, "Urban Drainage Design Manual (HEC-22)*. The gutter spread and inlet interception (for all inlet types) is a function of the equivalent slope ( $S_w$ ) for the inlet. Because of the difficulty of computation and iterative process, the design consultant is encouraged to utilize FHWA approved software to complete the analysis.

[FHWA Urban Drainage Manual HEC-22](#)

2. The required length and efficiency of an inlet within a depressed gutter section can be found by evaluating the equivalent gutter slope  $S_w$  in the above equation, where:

$$S_w = S_x + a/W$$

Where:

$S_w$  = Cross slope of the gutter measured from the cross slope of the pavement,  $S_x$

$a$  = gutter depression (in)

$W$  = gutter width (in)

$E_o$  = Efficiency =  $Q_w/Q$  ratio of flow in the depressed section to total gutter flow

$Q_w$  =  $Q - Q_s$  flow in the depressed section (cfs)

$Q_s$  = Flow in the Road (cfs)

$Q$  =  $Q_s/(1-E_o)$  total gutter flow (cfs)

$T$  = Top width of flow/Spread (ft)

$T_s$  = Top width of flow/Spread on pavement slope (ft)

Notes:

- The design consultant must determine the local gutter depression at the inlet throat for each inlet.

- $Q_w$  must be computed algebraically in the equation above rather than read from charts in Chapter 4, HEC-22.
- The designer may use FHWA supported software Visual Urban (or equivalent when approved by DPIE).

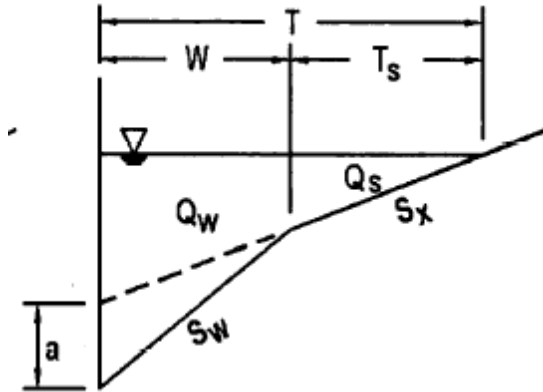

Figure 8-4 Curb Flow Cross Section

3. Inlet Efficiency

The efficiency of curb-opening inlets shorter than the length required for total interception is expressed by the following equation:

$$E = 1 - (1-L/L_T)^{1.8} \quad \text{Eq. 8-8}$$

Where:

E = Efficiency of the Curb Opening

L = Curb Opening Length (ft)

$L_T$  = Curb opening length required to intercept 100% of the gutter flow, (ft)

The equation shown is for simple gutter computations. When composite gutters are utilized, the designer should utilize the methods outlined in the HEC-22 1 to complete the analysis.

4. Sump Inlet Spread

Sump inlets shall be designed to pick up 100 % of the (design) storm while maintaining a roadway spread of no more than 8 feet. The length of

a curb opening inlet in a sump is determined by the following relationship:

$$Q = 3.0 * L * D^{1.5} \quad \text{Eq. 8-9}$$

Where:

Q = Flow to the inlet (cfs)

L = Length of the inlet throat (ft)

D = Depth of water ponding at the inlet (ft)

This equation only applies to simple gutter curb opening inlets under weir flow conditions. Analysis of weir flow or orifice flow at composite gutter sections should be analyzed using HEC-22 methodology. If the curb opening becomes fully submerged, the orifice equation from HEC-22 shall be employed. To determine the ponding depth at the inlet (d), the designer should consider both the allowable roadway spread as well as the height of the curb section.

Sump yard inlets shall be designed to capture 100 % of the design storm while maintaining a ponding depth of not more than 1 foot and a freeboard of 0.5 foot or more within the ditch. For weir type inlet openings, Equation 8-8 may be used to determine the ponding depth.

Computations shall be provided for all inlets within or that affect the County system.

- D. Off street inlets, which are not in traffic ways or are protected from traffic, such as those in grassed swales or yards, may be open-throated area inlets or swale inlets. Capacities for these types of inlets shall be determined by the appropriate weir or orifice formula, using a broad-crested weir discharge coefficient of 3.0 and an orifice discharge coefficient of 0.6. The maximum 10-year non-clogged ponding depth shall be 6 inches and is based on a 50% reduction in capacity.

E. **Structures, Manholes, and Inlets**

Modifications to structures in the County's Standard Details for Stormwater Management Construction may require structural computations and certification by a Professional Engineer, licensed in the State of Maryland. For public and private storm drain systems, County standard structures are to be used, if possible. MSHA drainage structures may also be used if County standard structures are not viable. Any modification to the standard details will be considered a non-standard structure, which may require a special structural design. This will be

noted on the detail as “modified” to differentiate from the standard detail. Depending on the revision, the structure dimensions may need to be sealed and signed by a Professional Engineer licensed in the State of Maryland.

1. All structures are to be numbered and listed in the structure schedule. Information to be included in the structure schedule include type of structure, standard detail number, size, top elevation, invert of outgoing pipe, underdrain location and invert, slot locations and invert, modification notes, and other information as necessary.
2. Access structures such as manholes or inlets shall be spaced at a maximum distance of 400 feet unless approved by the District Engineer. In no case shall the distance be greater than 500 feet.
3. Structures should be placed with consideration given for ease of maintenance access. The County may require shorter distances under some circumstances. If approval is granted for slopes less than the minimum, the maximum distance between manholes shall be 300 feet.
4. Inlet structures that are used to collect grit for infiltration trench pre-treatment must be reinforced concrete.
5. Additional structures will be required for outfall reaches on steep slopes (greater than 10%) to reduce excessive pipe depths and/or to provide deliberate drops in the main line to facilitate safe conveyance to a proper outfall discharge point. In order to provide a pipe outfall at a suitable slope (i.e., less than 1% slope), drop structures may need to be utilized to reduce the velocity before discharging onto a riprap apron.
6. Where two or more pipes enter a concrete structure, a 3-inch minimum clearance from outside of each precast opening or manhole joint for the pipe must be maintained between the pipes. For masonry structures the minimum horizontal clearance shall be 6 inches.
7. Non-standard inlets may require special structural design review and approval by DPIE. All precast structures not included with the County or MSHA standard structures require shop drawing approval by DPIE.
8. The determination of the minimum width of a structure based on incoming pipes is based on the following formula (see Appendix 8-21 for example sketch):

$$W = (D+E)/\sin \theta + T/\tan \theta + 6" \quad \text{Eq. 8-10}$$

Where:

D = Pipe diameter (outside) +

E = Precast opening for both sides, generally 6"

T = Inlet wall thickness

W = Min. structure width (inside)

$\theta$  = Angle of pipe entering structure. The angle must be greater than 45 degrees when entering a flat wall.

The opening shall be a minimum of 3" from a joint or wall.

9. For 2"-6" wide A-Inlets, only a 15" RCP may enter the narrow side. Larger pipes require a larger width A-Inlet.
10. Generally, yard inlets are to be minimized on residential lots. All reasonable efforts shall be made to grade swales on lots towards the street in the front, or a natural channel/preserved area in the rear to avoid placing yard inlets on the lot.
11. Yard inlets at low points if clogged shall not have a ponding depth greater than 2 feet to an overflow elevation. The measurement of depth is from the lower of the throat or grate opening to the overflow elevation. The overflow elevation shall be at least 1 foot below the lowest entry point to a structure.
12. The maximum discharge of 0.5 cfs per foot of opening for slot type inlets may be used in lieu of calculating a depth of ponding for the 10-year storm in lieu of using Section 8.3.5.D. The flow accounts for a 50% reduction in flow capacity.
13. For yard inlets, assume a 50% reduction in capacity to calculate WSEL, which may not exceed 6 inches or 3 cfs if crossing a lot line, whichever is smaller.
14. Underdrain locations and elevations must be noted by the design consultant. It shall include consideration for modified paving sections, location of underdrain within curb section from County standard detail 300.13 or 300.14, minimum clearance from adjacent pipes and joints, etc. The precast manufacturer shall provide knockouts for the underdrains. The following information was developed to guide the designer for the appropriate depth. Under no circumstances shall an underdrain invert be higher than 30 inches below the adjacent top of curb. The invert of the underdrain pipe must also be set no lower than the centerline of

8-40

the outgoing storm drain pipe. The design consultant is responsible for verifying all elevations and accounting for potential conflicts from parallel storm drain pipes.

A-Inlet (Side and Rear)	30 inches
A -Inlet (Front)	36 inches
E- Inlet	22 inches
K-Inlet (Front or Rear)	15 inches
J -Inlet (Ditch Side)	27 inches

### 8.3.6 Roadside Ditches

Generally the use of these criteria for roadside ditches shall be used in connection with the design and construction of new rural roadways. However, the criteria may be applied in other cases, e.g., to existing roads without curb and gutter, median ditches, and ESD. Design consultants are required to treat roadway runoff through ESD design rather than conveying runoff to structural practices. Therefore, open-section roadways present an opportunity to provide water quality within the roadside ditches. Where conditions permit, disconnected sheet flow design may be considered in lieu of providing roadside ditches.

#### A. Design Criteria

1. Ditches are considered integral components of the County drainage system. Generally, roadway ditches shall be V-shaped in accordance with DPW&T standard details. Trapezoidal ditches are preferred when used for water quality measures such as grass or bios wales. Other channel cross sections will be considered for approval under certain conditions. They shall be designed to provide sufficient hydraulic capacity to convey the estimated runoff from a 10-year frequency storm at a non-erosive velocity. The estimated runoff shall be calculated using the methods described in Section 8.2 of this manual.
2. Ditch capacity shall be calculated using Manning's formula. The appropriate roughness coefficient for the ditch lining under consideration shall be selected from Table 8-12 on page 8-56.
3. For non ESD ditches, the minimum acceptable grass V-ditch gradient is 2.0%. Concrete lining shall only be used when velocity exceeds the maximum allowable for grass ditches or when the ditch gradient is less than 2.0%. The minimum acceptable concrete ditch gradient shall be 1.0%.



In certain instances when grass or concrete lining is not deemed appropriate by the designer, other approaches or materials, such as check dams or grass channel stabilization materials, may be considered and approved by DPIE. A waiver request may be submitted to DPIE for ditches that cannot meet the minimum required grades due to the roadway longitudinal grade. A waiver for ditch slopes unable to meet designated slope is not considered a "road code waiver."

4. In no case shall the 10-year flow in a roadside ditch or swales have less than 9 inches of freeboard to the edge of the paved road or shoulder.

When this depth is exceeded, the runoff must be intercepted by an appropriate storm drainage inlet and conveyed in a pipe from that point to an acceptable outfall. In those situations where introducing an enclosed drainage system is not feasible, with prior approval of DPIE, a change in the ditch section characteristics may be permitted. Except at driveway crossings and street crossings where the outlet conditions allow for ditch flow (i.e., depth exceeds 1 foot) enclosed pipe systems must be used in lieu of culverts.

5. The design plans for roadways with a roadside ditch that is not the typical standard shall include the following for the 10-year design storm: the estimated velocity (V) in fps, depth of flow (D) in feet, and quantity of flow (Q)(max 15 cfs) for the following locations:
  - a. Ditch at intersections
    - Where ditch terminates at intersection
    - Where ditch flows from side roads to mainline around fillet
    - Where ditch flows to mainline from side road
  - b. Uphill side of all inlets including flow directions of the ditch leading into a sump
  - c. Locations where ditch flow, depth, or velocity is significantly affected by:
    - Offsite ditches or pipes connecting to ditch
    - Increase in drainage area

- 
- Change in ditch gradient or channel roughness factor
6. Ditch invert elevations shall be shown on the design plans at the following locations:
    - a. Around intersection fillets
    - b. 50-foot intervals through crest and sag vertical curves
    - c. Around the bulb of cul-de-sacs
    - d. Through transitions from swale sections to full ditch sections
    - e. At other critical, points
      - Temporary turnarounds
      - Low points
      - High points
- B. Driveway Culverts
1. Driveway pipes are to be utilized to provide conveyance of flow past driveways. While the maximum permitted depth of flow for any roadside ditch shall be one foot, a headwater of 6 inches above the crown is permitted for driveway culverts. Driveway culverts shall be designed to operate at the velocity of the incoming ditch, neglecting both entrance losses to the culvert and the pressure flow due to headwater. Ditch flow depths to driveway culverts may not exceed 1-foot for the 10-year storm. Drainage areas to driveway culverts may not exceed 2.5 acres. If 1-foot ditch flow depths are not attainable or the drainage area is greater than 2.5 acres, the flow must be conveyed through a closed (underground) pipe system.
  2. Driveway swales shall not be considered an adequate alternative to a driveway culvert and are not permitted. Trench drains may be considered in lieu of a driveway culvert if it is not feasible, however, the trench drain shall be designed for HS-20 loading requirements.

3. Driveway entrances at high points along the roadway profile may qualify for a driveway culvert waiver provided that the grades on either side drain away from the driveway entrance.
4. All driveway culverts shall have a minimum cover of 1 foot. Pipe end walls shall be installed on all driveway pipes; however, end walls shall only be placed when outside the clear zone for the proposed roadway in accordance with Standard SD 200.06 or 200.07.

### 8.3.7 Outfalls

- A. An outfall is the discharge point of the downstream extreme terminus of a culvert, open channel, or a closed storm drain system. The outfall may be an existing or proposed closed storm drain system, open ground, stream, channel, or open water such as ponds or lakes. An outfall is considered adequate if:
- The receiving closed storm drain system is not surcharged by the design discharge from the outfall pipe.
  - The receiving open ground, stream, channel or open water can accommodate higher velocities created by the design discharge from the outfall pipe.
1. Rights to discharge or offsite easements shall be required when the following occurs at an outfall, which directs runoff to an offsite location:
    - a. The manner of flow is changed, e.g., from sheet flow to a concentrated flow, or
    - b. The location of the discharge point is altered or moved, or
    - c. The quantity of flow is increased.
  2. Riprap will be provided to protect against erosion. However, excessive use of riprap should be avoided in order to reduce stream warming and improve aesthetics. All riprap shall be placed at 0% at outfall locations of storm drain pipe or SWM facilities unless the pipe is discharging into a wet pond. Design computations for velocity at the end of the riprap will use the riprap cross section and a 0.1% slope, in conformance with PGSCD design guidance.
  3. For the purpose of design of suitable energy dissipaters at the outfall, the partial flow velocity based on the actual slope of the proposed outlet pipe shall be computed. Computations must be

furnished to substantiate that the 10-year velocity onto natural channel, sodded/seeded channel, or existing ground is reduced to 5 fps in cut and 4 fps on fill (lower velocities may be necessary depending on soil and grass type).

4. Riprap outfalls shall be designed in accordance with Figures D.2 and D.3 from the “2011 Maryland Standards and Specifications for Soil Erosion and Sediment Control.” The design consultant shall provide design data for the outfalls on the design drawings to include length, width, thickness of apron, a grouted riprap cutoff wall depth of 3 feet and width of 2 feet for Class I riprap (Class II or III do not required the cutoff wall), geotextile filter fabric, and other pertinent data as deemed necessary by the DPIE or PGSCD. See Appendix 8-22 for estimating riprap Manning’s “n” value based on depth of flow, and Appendix 8-23 for velocities versus riprap size. Provide typical detail on plan. Riprap classification is shown below in

Table 8-10.

5. Projects with SWM must coordinate the riprap sizing and class type for storm water design with storm drain design in order to avoid confusion in material selection.

**Table 8-10 Riprap Classification**

Class	Gradation by Minimum (Maximum) Weight (lbs)			D <sub>50</sub> (in)	D <sub>50</sub> (in)	Minimum Thickness (in)
	0%	50%	10% (max)			
0	33	10	1	5.5	7	11
I	150	40	2	9.5	15	19
II	700	200	20	16	24	32
III	2000	600	40	23	34	46

**NOTE:** Table corresponds to MSHA and MDE Riprap Classifications

A filter will be placed between the riprap blanket and the underlying soil surface. The filter can be of two general forms: a gravel layer or geotextile fabric. A gravel filter, when used, shall be designed by comparing particle sizes of the overlaying material and the underlying soil surface. The geotextile fabric shall be as approved by DPIE/PGSCD.

6. Riprap outfalls are also subject to PGSCD revision and approval for any project under which it has jurisdiction.

7. The riprap channel bottom width will be equal to the bottom width of any flared end section, or 1.75 times the inside diameter of the outlet pipe/culvert. The riprap channel side slopes shall be a maximum of 3:1 in residential zone areas or 2:1 for commercial or industrial zoned properties. When riprap channels are located at culvert or pipe outfalls, the apron shall extend up the bank to at least the height of the pipe/culvert.
8. Where the grade beyond the outfall is steeper, causing flow velocities to increase beyond 5 fps, additional conveyance protection, i.e., riprap, geotextile fabrics, or gabions, may be required unless documentation is provided showing that the type of vegetation and soil is sufficiently erosion-resistant.
9. Riprap shall not be placed in open channels or ground that has a longitudinal grade greater than 10%. Slopes greater than 10% require the use of gabions or other materials to be acceptable to DPIE and PGSCD. Pipe outfalls to floodplains or other natural areas shall be extended to the point where the average downstream slope beyond the riprap is less than 5% excluding the stream channel.
10. For outfalls with pipe diameters of 10 inches or less into an ESD device, the apron shall be at least 3 feet long and 1.5 feet wide and consist of Class 0 riprap. Other options may be considered for very small drainage areas.
11. For pipe sizes equal to or less than 21 inches in diameter, with a partial flow velocity of less than 5 fps, provide a minimum riprap apron length of 5 feet.
12. For pipes larger than 21 inches in diameter with a partial flow velocity of less than 5 fps, provide a minimum riprap apron length of 10 feet.
13. Use Class II (minimum  $d_{50} = 12"$ ) riprap at outfalls for pipes 30 inches or larger in diameter.
14. When discharging towards an existing stream channel, the outfall shall avoid a perpendicular intersection with the stream.
15. Transition of the riprap section to the natural section shall be shown on the design drawings, which could include but are not limited to contours.
16. If a plunge pool is proposed at the outfall, in lieu of riprap apron, use the design and detail guidelines in the *2011 Maryland Standards and Specifications for Soil Erosion and Sediment Control*

Section D-4-2. Since the depression dissipates excessive energy in turbulence by allowing both vertical and horizontal expansion downstream of the culvert, a significant reduction in stone size is achieved by the excavation. The two types of preformed scour holes are as follows:

Type I - The depression is equal to one-half of the culvert rise

$$D_{50} = (0.0125d^2/T_w) * (Q/d^{2.5})^{1.33} \quad \text{Eq. 8-11}$$

Type II - The depression is equal to the full culvert rise

$$D_{50} = (0.0082d^2/T_w) * (Q/d^{2.5})^{1.33} \quad \text{Eq. 8-12}$$

Where:

$D_{50}$  = Diameter of Average Size Stone (ft)

$d$  = Diameter of outlet for circular, Height for all other shapes (ft)

$T_w$  = Tail water Depth above invert of storm drain outlet (ft)

$Q$  = Discharge (cfs)

See Report Number FHWA-RD-75-508 *Culvert Outlet Protection Design: Computer Program Documentation* or FAA AC 150/5320-5C *Surface Drainage Design* for additional information.

17. If gabions are proposed as a means of dissipating energy at an outfall location, the design consultant is responsible for providing computations, references, and details to support the design. A gabion profile, sections, details, and construction specifications are required on the design plans showing gabion dimensions, stone size, basket dimensions, and geotextile fabric.
18. Computer programs for the computation of outfall effectiveness shall be approved by the DPIE and PGSCD in writing prior to use by the design consultant.
19. See Section 9.7.1.10 for storm drain outfall design considerations into a SWM facility.

### 8.3.7.1 Storm Drain System Entrances and Stabilization

Entrances to storm drain systems may consist of headwall entrances to enclosed drainage systems or culvert entrances. Adequate field survey or aerial topography is required to ensure that the storm drain system is

aligned with the existing or proposed flow path. In addition, the limits of ponding shall be displayed on the construction plans and pipe profiles for the headwater associated with the design storm and 100-year storm events. The channel invert and tops of banks of the incoming drainage course(s) are to be shown on the plan and profile views.

Storm drain entrances are not to be located on developed lots except in extenuating circumstances, with special permission from DPIE. Unless otherwise approved, the 100-year storm backwater elevation should be located outside of lots or be contained within a ponding easement to limit construction within the ponding area. For culverts in floodplains, no increase in the 100-year headwater elevation off-site is allowed unless an easement is obtained.

An end section or headwall is to be used where the entrance is to be the terminus of the enclosed system. A cutoff wall may only be used when future extension of the system for the project is anticipated. The structure shall be located sufficiently beyond the proposed development so that re-grading will not be required on occupied lots of this development when the system is extended.

- A. Storm drainage entrance and outfall structures are not to be located on developed lots, except in unusual circumstances, with special permission from DPIE. Headwalls and end walls located on offsite properties require easements. Where required, the applicant is responsible for acquiring the offsite easements and should recognize the need to plan for this possibility early in the process.
- B. Endwell/headwalls on M-NCPPC property require separate approval and details from M-NCPPC DPR prior to final approval by DPIE.
- C. The limits of ponding for 10 and 100-year storms are delineated for proposed conditions at all headwalls at the beginning of a storm drain system. Only the 100-year is required for a culvert. Maximum ponding elevation shall be noted. Show overflow path in the event of blockage.
- D. Where culverts are provided, the shape and length of culverts and the grading of culvert inlets and outlets shall be designed and constructed to facilitate periodic maintenance to remove obstructions.

#### 8.3.7.2 End Treatments

- A. All culverts and pipes (entrance or exit) will be protected with end treatments.
1. Headwalls
    - Use to anchor pipes to prevent uplift
    - Must be outside the clear zone (clear zone as defined by AASHTO)
    - Must be beveled based on standard details
    - Improved entrances shall only be used when approved by DPIE. The FHWA publication *Hydraulic Design of Improved Inlets for Culverts HEC 13* will be used.

[Hydraulic Design of Improved Inlets for Culverts](#)

2. Wing walls
    - Use to contain roadway embankment for culverts greater than or equal to 4 feet.
    - Use when channel side slopes are unstable.
    - Use when culvert is skewed to the normal channel flow.
  3. End Sections (For private driveways only with no easement)
    - Use if no base flow is present.
    - No backwater conditions are anticipated.
    - Span is less than 36 inches; 30 inches within the clear zone.
- B. All end treatments shall be protected from traffic.
1. Culverts/pipes less than 30 inches located within the clear zone shall use a safety slope end section or sloped headwall,
  2. Culverts/pipes greater than 30 inches may have various treatments as follows:



- Extend pipe to have headwall outside clear zone.
- If pipe extension is not possible, shield end treatment with traffic barrier.

C. Longitudinal Storm Drain with End Treatments

For storm drain systems (not cross culverts) where headwalls are used in lieu of inlets, headwater computations for the design storm and 10-year storm shall be provided. The maximum relationship of the headwater depth to the pipe diameter (HW/D) shall be in accordance with Section 8.5.2 for the design storm.

### 8.3.8 Drainage Swales and Surface Drainage Easements

The centerline of a drainage swale or storm drain shall be 15 feet minimum to a residential structure. Swales should be placed at the rear of the property beyond the Building Restriction Line (BRL) or in open space to maximize the use of the lot. When swales pass between residential units, the swale shall be centered between the units unless otherwise approved.

The maximum drainage area feeding any swale located in backyards and front yards shall be 2.5 acres. All flow shall be captured by a closed conduit system when the drainage area exceeds 2.5 acres or 3 cfs when crossing a lot line.

A surface drainage easement will be required when the flow crosses the third property line. This includes parcels or outlots.

1. For areas outside the public right-of-way, the maximum drainage area to a private driveway on a pipe stem lot shall be 1 acre or 3 cfs, whichever is less.
2. The maximum drainage area to any yard swale between two houses shall be 3 cfs (County Code Sec. 32-162(a)(6)) for the 10-year storm event, whichever is less. All flows exceeding these values shall be collected by a closed conduit system unless discharged into a floodplain, woodland conservation area, or other protected area.
3. The minimum distance from the centerline of a yard drainage swale shall be 15 feet to the rear of a residential structure. Generally, the swale should be placed at the rear of the property beyond the BRL or in open space to maximize use of the lot, except where swales pass between structures on both sides.

### 8.3.9 Sump Pump Discharges

Prince George's County regulates sump pump discharges to protect public safety and to prevent the creation of public nuisances.

A. Types of sump pump discharges allowed:

1. Discharge to an existing County facility
  - Requires a Special Drain Permit prior to connection to existing public drainage system.
  - Existing facility may be connected to a storm drain pipe, inlet, or manhole.
  - May require use of a backflow prevention valve.
2. Discharge to a roadside swale without curb
  - Discharge may not erode the swale.
  - Erosion that occurs must be repaired by the homeowner.

B. Alternative discharges of sump pumps

1. No approval required if alternative devices are located within private property.
  - Dry Wells or Rain Barrels
  - Rain Gardens

## 8.4 Ditches and Open Channel Systems

Open channel systems consist of non-standard roadside swales or ditches, off-road drainage and flood channels, and natural streams. The County strongly discourages the creation of any new improved channels outside of the public right-of way. The use of any new improved open channels requires the approval of the Director. However, many existing improved open channels within the County may require repair, or natural streams may require rehabilitation. These guidelines apply to non-standard road swales and other open channels. For drainage facilities within an MSHA right-of-way, MSHA's design criteria shall be used.

### 8.4.1 Computations

Computations shall be provided for all channels, accompanied by a typical section of each reach, and a plan view with typical section locations clearly marked. In the case of existing streams or swales, which are to remain in a natural condition, field run survey data is necessary to prove the streams will remain stable.

- Field survey shall be provided at least 200 feet beyond the limits of the channel improvements.
- The channel invert and tops of banks are to be shown in plan and profile views.
- For designed channels, a cross-sectional view of each configuration shall be shown.
- For designed channels, limits of grading shall be shown.
- The limits of a recorded 100-year floodplain easement or surface drainage easement sufficient to convey the 100-year flow shall be shown. A standard storm drain easement for improved systems shall not be used for natural channels.
- For designed channels, transitions at the beginning and end are to be clearly shown on the plan and profile views.
- Limits and types of bank protection are to be shown on the plan and profile views.

Open channels will be designed to convey the 10 year storm within the channel . Open channel calculations shall define the 100-year storm limit. For any open channel with a drainage area greater than 50 acres, a proposed floodplain study must be prepared. Channels shall be designed with a freeboard of 0.5 feet and designed for the 10 year storm frequency. The freeboard may need to be higher to provide for hydraulic jumps, super elevated sections, and other special situations.

Velocities in the channel and banks must be such that erosion will not occur, or appropriate stabilization must be applied. Refer to the permissible velocities in Table 8-11.

Computations shall include slope, cross section, roughness coefficient, velocity and quantity of discharge for each section or reach of channel. Unless otherwise directed by DPIE, the Manning's equation will be used for channel design. Where perennial or intermittent streams are encountered or a base flow is present for extended periods, the design consultant should consider implementing a sub-channel that displays characteristics of natural channels.

These channels may require a Joint Permit to be submitted with the USACE and MDE.

Each open, designed channel must have the following shown on a cross section within the submitted plan set:

- Channel Dimensions and Side Slopes
- Design storm WSEL
- Bank full and BFE (if required for Joint Permit Application)
- Riprap classification
- Riprap blanket thickness

#### 8.4.2 Velocities

1. The maximum velocities for improved open channels for the 10-year storm are provided in Table 8-11 and will depend on the lining material and its erodibility.
2. Whenever possible, ditches or swales shall be planned to discharge into the same natural outfall to which their drainage area discharged before road construction or development commenced.
3. Where the topography and other factors prevent the maintaining of maximum allowable velocities within the system, the following measures may be used to dissipate the energy:
  - a. Drop structures to dissipate energy at the entrance, at intermediate points, or at the outlets of drainage conduits;
  - b. Baffles at outlets of drainage conduits;
  - c. Stilling basins at the outlets of drainage conduits; or
  - d. Check dams.
4. Velocities in sodded grass channels must be such that erosion will not occur. The maximum allowable velocity for a 10-year storm is provided in Table 8-11. Necessary erosion protection must be provided for higher velocities in a grass or natural ditch/channel if the velocity is greater than 4 fps. The 10-year storm is based on the design considerations of MSHA; see page I-3-A-1 from the *Highway Drainage Manual* for more information. Concrete channel minimum slope shall be 0.5%.

Table 8-11 Limiting Velocities for Ditches and Channels

<u>Type of Lining</u>	<u>Allowable Velocity (fps)</u> <u>(10-yr Storm)</u>
Seed and Mulch	2.5
Solid Sodding	4.0
Soil Stabilization Matting	4.5
Concrete Channels	No Max.
Rock	5.6
Riprap	Refer to MSHA Chart -61.1-405.1
Class 1	8.0
Class 2	10.5
Class 3	12.5
Open Weave Geotextile Lining (Jute Mesh or Equiv.)	4.0
Erosion Control Blanket/Soil Stabilization Mat (Landlok435, 450, 460, 1060 or Equiv.)	7.0
Turf Reinforcement Mat (Pyramat 4700 or Equiv.)	10.0
<b><u>For Investigation of Existing Channels</u></b>	<b>MSHA 61.1-405.0</b>
Earth, without vegetation	1-3
Grains, stiff stemmed grasses	2-3
Bunch grass	2-4
Stiff clay or clay and gravel	3-5
Fine gravel	5.0
Meadow type grasses, short pliant blades	5.0
Well-established grasses, short pliant blades	6.0
Coarse gravel	6.0
Rock	No Max.

### 8.4.3 Open Channel Design Criteria

- A. Manning's coefficient based on:
- Existing conditions unless changes in the coefficients are included in the proposed project. See Table 8-5 for guidance.
  - The highest seasonal variation of the coefficient.
- B. For improved channels, the profile and velocities of the natural stream shall be examined, both upstream and downstream of the proposed development at the following locations:
- At the beginning and end of the improvements for all projects;

2. Within 5 feet of the property line for all projects;
  3. 200 feet for projects with drainage areas less than 50 acres; and
  4. 500 feet for projects with drainage areas between 50 and 300 acres.
- C. Occasionally the design of steep channels will require the consideration of super elevation. The design consultant shall refer to Chow V.T., *Open Channel Hydraulics*, or equivalent, for analysis methods.

#### 8.4.4 Designed Open Channels (not part of a typical open road section) and Natural Streams

1. Requires Director approval for any new open channel at the SDCP phase.
2. Channel invert and tops of banks are to be shown in profile views of the main stem and the incoming and receiving drainage course(s) are to be shown on the plan and profile views. Existing ground elevation at both banks and existing centerline elevations should be shown in profile.
3. For designed channels, a cross-sectional view of each change of configuration shall be shown.
4. The limits of the existing and proposed 100-year floodplain easement or surface drainage easement conveying the 100-year flow shall be shown. A DPIE floodplain letter and approved 100-year floodplain delineation must be obtained prior to release of the permit.
5. For designed channels, a transition area at the entrance and outfall is to be clearly shown on plan and profile views. Contours of the existing or proposed channel must adequately delineate the extent of the channel configuration.
6. Limits and types of bank protection are to be shown on the plan and profile views. For natural channels, sufficient easement and bank protection are required to ensure the channel will remain within the easement and as delineated on the plan view.
7. Channels with 10% or greater slope should be lined with gabions or other material deemed acceptable to DPIE and PGSCD. For all channels with 10% or greater slopes, 3-foot deep grouted gabion or concrete cutoff walls must be provided at horizontal intervals

equal to the ratio of the cutoff wall height to the slopes of the channel (i.e. 3'/0.1 = 30').

8. Channel side slopes for paved or lined channels are limited by the selection of the paving or lining material. In general, slopes 3:1 or flatter will be acceptable for all materials. Side slopes steeper than 3:1 up to 2:1 will be permitted for all material except grass to be mowed. Slopes steeper than 2:1 are not permitted for vegetated channels.
9. Slopes steeper than 1:1 will be considered a structural element for slope stability and should be designed as a retaining wall. The design consultant should consider the incorporation of more than one material and side slopes in the design to take advantage of the economies of material and construction methods.
10. Open channels shall be designed to maintain pre-existing channel alignment as much as possible. Open channels shall be designed to avoid sharp bends, and to avoid alignments running through the center of a property. Preference will be given to maintaining the stream and its buffer in its natural condition. Degraded portions of channels will be restored to as near natural condition as practical.
11. Normal depth calculation shall be determined by using Manning's equation. For most applications, other than 100-year frequency design, the design of open channel systems based on normal depth will be sufficient. Normal depth is calculated iteratively by Manning's Equation using different estimates of depth as follows:

$$Q = 1.486(AR^{2/3} S^{1/2})/n \qquad \text{Eq. 8-13}$$

Where:      Q = Flow rate, in cfs  
               A = Cross sectional area of flow, in sf  
                   n = Manning's roughness coefficient  
                   R = Hydraulic radius, in feet  
                   S = Hydraulic gradient or the slope of the channel invert for normal depth calculations, in feet per foot

The design consultant may use the hydraulic tables found in the *Handbook of Hydraulics* by Brater & King (McGraw & Hill).

12. Friction Losses - Head loss due to friction (HF) in open channels with uniform flow shall be determined by the Manning's Formula:

$$S_F = \frac{(nV)^2}{2.208R^{4/3}} \quad \text{Eq. 8-14}$$

$$H_F = S_F \times L$$

$S_F$  = the friction slope in ft. of drain.

### 8.4.5 Design Depth

1. Waterway Depth
  - a. For side ditches in road sections, depth of flow shall not be allowed to exceed the depth of the side ditch or be less than 9 inches below the edge of the paved road or shoulder.
  - b. The design depth in steep channels shall not be less than critical depth.
2. Maximum velocities for steep channels, however, shall be calculated based on normal depth. Velocity computations that reflect the average slope, cross section, roughness, and quantity of flow must be provided for each reach. The design storm used for open channels is the 10-year storm for less than 50 acres and 100-year storm for greater than 50 acres.
3. The following Manning's "n" roughness coefficient may be used for channel design:

**Table 8-12 Manning's Roughness Coefficients for Manmade Channels**

Concrete	0.013
Bituminous Concrete Paving with Concrete Gutter	0.015
Grouted Riprap	0.030
Stone Masonry	0.032
Soil Cement	0.022
Asphalt	0.016
Bare Soil	0.020
Rock Cut (Smooth, Uniform)	0.035
Seed and Mulch	0.030
Sodded Channels where depth of water is less than 1.5 ft	0.050
Sodded Channel where depth of water is greater than 1.5 ft	0.035
Smooth Earth Channel or the bottom of wide channels with sodded slopes	0.025
Open Weave Geotextile Lining*	0.025
Erosion Control Blankets/Soil Stabilization Mat*	0.035

8-57



Turf Reinforcement Mat*	0.030
Gabion	0.030
Riprap Channels	Varies (see App.8-17)

- Freeboard shall be approximately 30% of the design depth subject to a minimum freeboard of 0.5 foot for systems designed for all storm frequencies of less than 100 years. The minimum freeboard for systems designed for the 100-year storm shall be 1 foot. The freeboard may need to be higher to provide for hydraulic jumps, super elevated sections, and other special situations.

#### 8.4.6 Materials

- Bioengineering methods of stabilizing will be considered in preference to structural methods for those portions of a channel where the design water velocities acting on the stabilized areas are less than the velocities that the stabilized area can withstand. Methods must be locally appropriate and include habitats and aesthetic considerations. See Table 8-11 for velocity limitations and Table 8-12 for suggested “n” values for the design of open channels.
- Earth or unlined channels may be considered for cases of non-eroding velocities. The proposed velocity for the entire reach shall not exceed the calculated value. Earth running slopes will not be steeper than 2%. Side slope erosion potential may require vegetative cover if slopes are steeper than 4:1.
- Use of erosion protection fabric is a preferred method of designing an open grass channel that allows the designer to accommodate higher velocities while still maintaining a more natural stream condition. Several manufacturers of geotextile fabric offer economical alternatives to gabions or riprap. The design for particular applications shall follow the design guidelines provided by the manufacturer. The design should include overlap dimensions and end burial, staking and check slot details. See the *2011 Maryland Standards and Specifications for Soil Erosion and Sediment Control* Section B-4-6 for additional information.
- Gabion channel lining offers an effective and flexible alternative to concrete and bituminous concrete materials. Gabion channel walls steeper than 1:1 shall be designed as gravity retaining walls that are designed to withstand surcharge due to equipment loads. The design consultant shall consider slope anchors, toe walls, and aprons to protect the gabion foundation. All gabions shall be placed on geotextile fabric or firm stone bedding. Any undercut shall be backfilled with size #57 stone.
- Concrete channels with wire mesh reinforcement may be selected where the design discharge is less than 100 cfs. The use of concrete channels for

greater design flows shall require prior approval by DPIE. The design of concrete channels shall consider flotation, the control of soil hydrostatic pressure with weep holes, adequate construction and expansion joints, drainage of subgrade, and cutoff walls.

6. Design of riprap bank protection should be based on either the Ishbash Equation per Section 2.1 of the *Maryland Guidelines to Waterway Construction* (MGWC) or Stable Channel Design using the tractive force methods.
7. Riprap size shall be determined using the methods outlined in the *2011 Maryland Standards and Specifications for Soil Erosion and Sediment Control*, or latest edition thereof. All riprap shall be placed on geotextile fabric.

### 8.5 Bridges and Culverts

In the past, culverts and other stream crossings were often sized strictly to convey the design discharge associated with the project. Little thought was given to the long-term environmental impacts associated with the construction of stream crossings. While stream crossings function to convey the peak discharge, the stream crossing becomes a barrier to aquatic habitat because of channel degradation or migration and impact to wetlands or riparian habitats.

Prince George's County promotes the use of environmentally sensitive stream crossings. Environmentally sensitive stream crossings promote the passage of aquatic habitat and minimize impact to wetlands and riparian buffers that surround streams, thereby promoting environmental stability. Where existing aquatic blockages occur, the County encourages the retrofit or replacement of culverts to promote aquatic habitat. For economic reasons, the County attempts to balance the environmental benefits with cost-effectiveness for construction and future maintenance.

This section establishes a set of guidelines that facilitate environmentally sensitive design of bridges and culverts for stream crossings. These guidelines apply to all projects that cross or intend to cross streams with a perennial flow or streams with intermittent flow. They also provide the design consultant with criteria and information for selection of an appropriate location and a suitable structure, while maintaining the natural integrity of the stream valley. However, these criteria are not intended to supersede the regulatory authority of the various Federal, State, or other local permitting agencies with which the designer must coordinate during design and approval of the project. All of the proper paths and requirements for submission of a "Joint Federal/State Application for the Alteration of Any Floodplain, Waterway, Tidal or Nontidal Wetland in Maryland" will be followed, if applicable.

The goal of these guidelines is to provide methods for the design and construction of roadway stream crossings that overcome issues experienced with past roadway construction design practices. This goal will be achieved by the following steps:

- Eliminate the degradation of the stream habitat, aquatic life, and water quality;
- Recognize and avoid the creation of physical blockages and impediments to the passage of fish and other aquatic life;
- Minimize the burden of infrastructure construction and maintenance for County taxpayers; and
- Coordinate and unify the requirements and needs of the various regulatory agencies involved in the environmental review of roadway stream crossings.

### 8.5.1 Classification and Review

Any culvert with an opening height of more than 6 feet is designated and reviewed as a bridge. Box culverts more than 6-feet wide are designated as bridges. Multi-cell culverts are designated as bridges if the distance (gap) between the cells is “one-half pipe diameter or less” and the total span (outside edge of cell to outside edge of cell) is more than 6 feet. If the gap between cells is more than one-half pipe diameter, each cell is considered an individual culvert and the multi-cell culvert is not designated as a bridge.

For multi-cell culverts situated at a skewed angle to the road (rather than the typical perpendicular orientation), the span is measured along the centerline of the road from outside edge of cell to outside edge of cell, and the same 6-foot span threshold applies for designation as a bridge.

Any culvert designated as a bridge will require review by the DPW&T Office of Engineering and Project Management (OEPM).

### 8.5.2 Waterway Openings for Culverts and Bridges

1. Culvert computations will consist of data similar to that used for sizing pipe systems. Use MD-378 Appendix B Small Pond Embankment Criteria to determine if a culvert must be constructed to small pond standards. Roadway culverts must be constructed to small pond standards if one of the following is present:
  - a. When headwater is more than 2 times the pipe size for the 100-year storm and if the  $H_W-T_W$  is greater than 10 feet;
  - b. When a permanent pool is deeper than 3 feet;

- c. When a riser is proposed; or
- d. When headwater is more than 1.5 times the pipe size for non-roadway culverts.

If the culvert does not meet MD-378 small pond "Class A" criteria, then the culvert and the embankment must meet MDE dam safety criteria and review.

2. A new culvert shall pass the 100-year storm flow with at least 1 foot of freeboard to the ground elevation at the public right-of way, to the edge of paving for an open section road, or the bottom of a new bridge superstructure. Retrofits at locations of existing bridges will be flexible based on the circumstances. Coordination with DPW&T is required as well as DPIE. No increase in WSEL is permitted on upstream properties unless an easement is acquired on upstream properties to encompass the larger floodplain. Culverts will require a permit and plan approval from DPIE and potentially MDE if they impact the floodplain.
3. deleted
4. DPIE and DPW&T will review the hydraulics, foundation and structural integrity for all bridges, and multiple culverts (a string of two or more culverts combined at one crossing).
5. The maximum number of cells shall be four for new construction. Retrofit locations may exceed this amount if conditions warrant.
6. Bridges or culverts with 17 feet of width but less than 20 feet from outside of structure to outside of structure shall be redesigned to 20 feet wide or greater.
7. For culverts or bridges longer than 75 feet, a minimum height of 6 feet is required.
8. A lower cell opening or other means to reduce sediment blockage of culvert may be considered.
9. Information shall be provided by the applicant in accordance with the *Standards and Specifications* for the submittal.

#### A. 2-Year Channel

Channels with a base flow will typically be designed with a 2-year channel. The following information is provided for information only. Review and enforcement of criteria for 2-year channels within culverts will be at the discretion of other agencies such as the USACE or MDE during the Joint Permit Application process.

Where practical, the proposed culvert will have, at a minimum, the same span as the existing channel. The portion of the culvert located within the channel must be designed to have the capacity to convey the 2-year runoff. There should be little to no increase in the WSEL for the portion of culvert located within the channel. The remainder of the culverts or structures may be placed either beside the culvert or in the floodplain. During transition grading between floodplain and culvert, grading of the 2-year channel is not allowed unless approved by the County (along with MDE and USACE if required). Transition grading of the floodplain to and from the culverts above the bank elevation of the 2-year channel is preferred.

Where open or closed bottom culvert spans are significantly larger than the 2-year channel width, the culverts shall be designed to incorporate a natural material channel inside the culvert at the same dimensions and roughness of the existing conditions.

B. Skewed Pipes

Culverts shall be as close to perpendicular as possible to the proposed roadway alignment. This will reduce material costs, the amount of roadway affected, and the duration of traffic diversion during installation and eventual replacement. Where culvert skew is required because of the existing channel alignment, the culvert shall be skewed along the stream to the minimum extent practical for the proposed roadway alignment. Culvert skew angle shall not exceed 45 degrees.

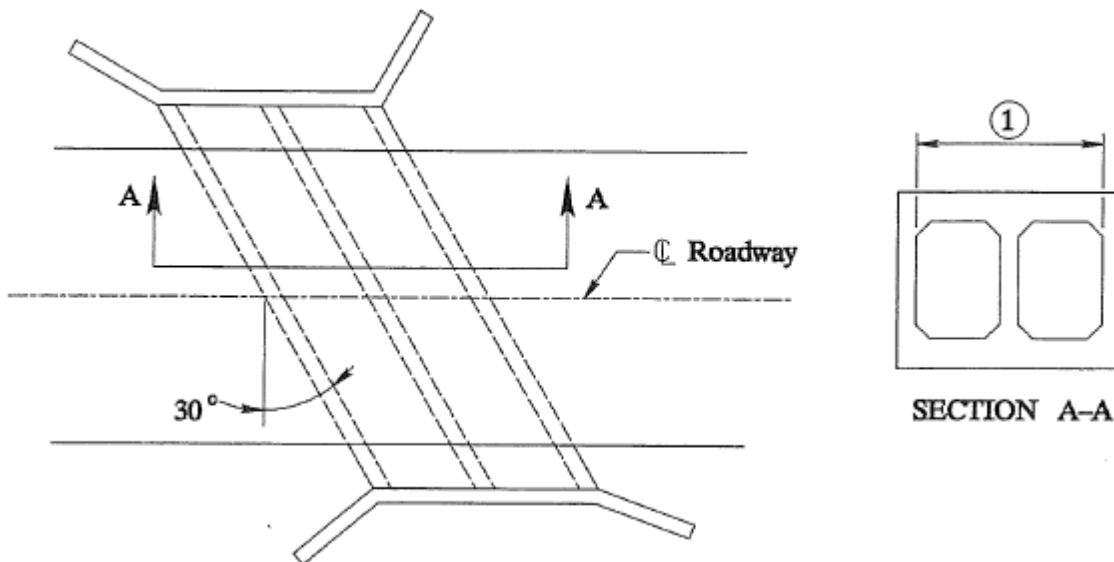

Figure 8-5 Culvert Skew Length

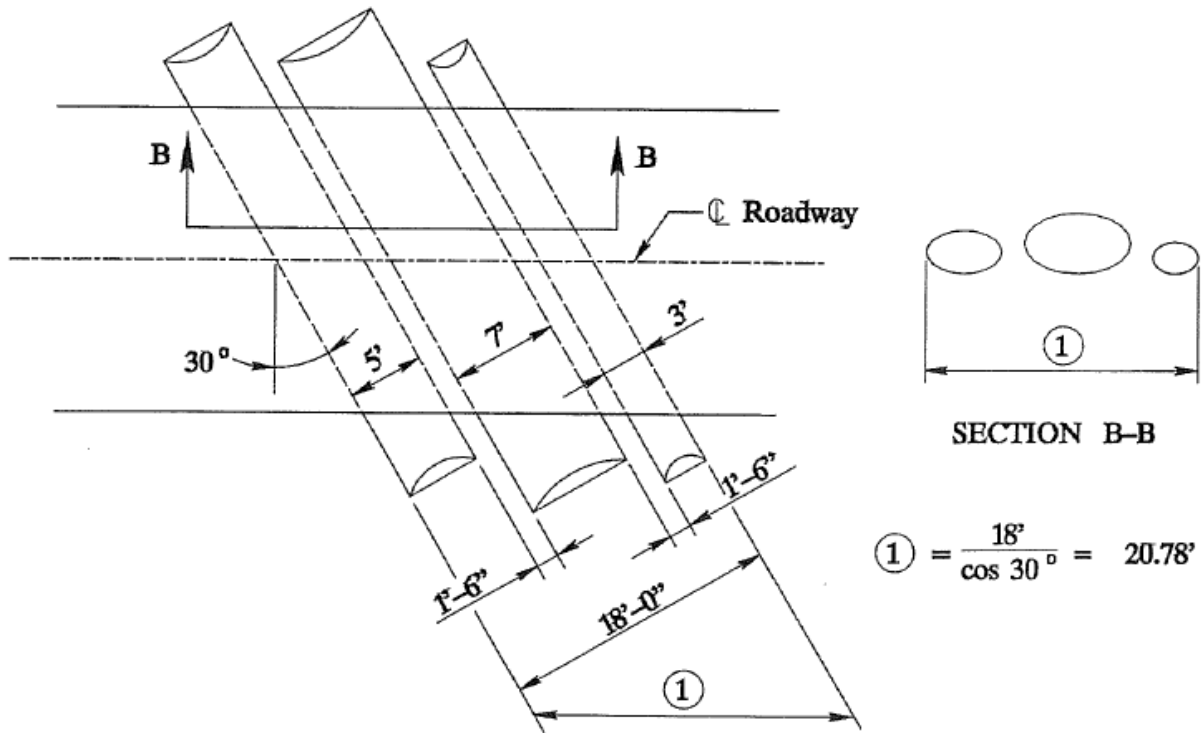

Figure 8-6 Culvert Skew Length for Different Size Pipes

C. Multiple Pipes

Culvert spacing will be a minimum of one-half pipe diameter or 3 feet; whichever is less. Multiple pipes must have a single barrel, sized adequately to convey the bank full runoff and promote aquatic passage.

The additional culverts shall be situated within the floodplain to facilitate conveyance of high flows; however, the additional culverts should not promote lateral movement of the 2-year runoff channel. This can be accomplished with inverts that are slightly higher than the invert for the barrel that conveys the 2-year runoff channel.

8.5.3 Types of Inlet and Outlet Stabilization for All Structures

Where possible, the crossing location should minimize the need to use riprap in the stream channel.

1. At Single Cell Culvert (upstream end): Riprap within the stream channel should only be used when necessary, and then only immediately adjacent to the headwall. Riprap upstream of culvert should be used for grade

control only when located within the channel. Other areas disturbed upstream of the headwall should be stabilized with soil erosion control fabrics and/or with native stream bed materials. Side slopes should be sodded or otherwise protected with vegetation. A concrete headwall with a footing of appropriate depth will be constructed to protect the roadway embankment from erosion due to scour.

2. At Single Cell Culvert (downstream end): Riprap shall be used only when other methods employed to prevent scour of the stream channel are not practical. The size of riprap and length of a riprapped channel or apron are dependent on the flow velocity of the 100-year storm. Side slopes of the stream channel should extend the riprap to the top of the pipe(s) or bridge opening. The slope of the riprap channel should be as close to the natural stream channel as possible. The anticipated scour depth will be computed for the entire culvert as necessary. A concrete end wall with a footing of appropriate depth shall be constructed to protect the roadway embankment.
3. The depth of anticipated scour for bottomless culverts or bridges will be calculated in accordance with the most current version of HEC-18, or other acceptable method approved by DPIE and DPW&T.
4. For multi-cell installations, stabilization of the inlet and outlet ends of the low flow cell shall be accomplished in the manner outlined above for the single cell culvert. The inlet and outlet ends of the flood cell pipes shall be stabilized for the 10-year storm. This stabilization should be placed so that it does not extend into the stream channel.
5. Hydraulic capacity for bridges and culverts shall be sized using one of the following methods:
  - a. FHWA Design Series No. 5 and No. 10;
  - b. USACE Computer Program, HEC-RAS;
  - c. FHWA/HY-8 Computer Program; or
  - d. FHWA Hydraulic Design Series No. 1, Hydraulics of Bridge Waterways.

The submittals shall include input computations, verification of entrance loss, cross sections and locations, and complete printout with profile and cross sections.

The 100-year overflow must always be considered. A detailed analysis will be required where habitable structures and property may be affected. The lowest entry elevation of any upstream structure must be at least 1

foot above the overflow elevation of any culvert crossing of a road or driveway.

## 8.6 COMPUTER SOFTWARE

In order to ensure proper design of projects, Prince George's County supports the use of software developed and supplied by various Federal agencies and the MSHA. While the County supports the use of software, it is the role of the design consultant to utilize software correctly for the design conditions at the site. When completing a Storm Drain or Hydrology and Hydraulics Report, it is the responsibility of the design consultant to provide a list of Federal and State software used for the project when it varies from the list below.

### 8.6.1 Hydrologic Software:

- Win TR-55
- Win TR-20

### 8.6.2 Bridge and Culvert Software:

#### A. Culvert Analysis

- HDS-5 Calculator (Estimation only, not for final design)
- HY-8
- HEC-RAS

#### B. Bridge Analysis

- HEC-RAS
- HEC-1 (only when approved for a specific project)

#### C. Scour Analysis

- HEC-RAS
- HEC-1 (only when approved for a specific project)
- Scour 8



This Page Intentionally Left Blank

---

## Chapter 9 STRUCTURAL PRACTICES DESIGN CRITERIA

### 9.1 Definition of Structural Practices

Structural SWM are all of the storm water measures that require approval by the Prince George's County Department of Permitting, Inspections and Enforcement as defined by County Code Sec. 32-179(b), as follows:

- (b) *Structural Stormwater Management Measures.*
  - (1) *The following structural storm water management practices shall be designed according to the Maryland Design Manual to satisfy the applicable minimum control requirements established in 32-178 of this Division:*
    - (A) *Stormwater management ponds;*
    - (B) *Stormwater management wetlands;*
    - (C) *Stormwater management infiltration;*
    - (D) *Stormwater management filtering systems; and*
    - (E) *Stormwater management open channel systems.*

These measures are implemented when nonstructural measures identified under County Code Sec. 32-179(a) are not feasible in meeting all of the site's storm water requirements with ESD practices or may be required to provide attenuation of the Overbank Protection ( $Q_P$ ) or Extreme Flood ( $Q_F$ ). However, structural practices can still be constructed for grandfathered projects, in accordance with the criteria in Section 9.2.

### 9.2 Grandfathering Provisions and Administrative Waivers:

Grandfathering and administrative waivers are defined in section 5.1.8 of this manual.

Structural BMPs are allowed only if:

- the project received a waiver as defined in 5.1.8; or
- it is a redevelopment project, and ESD cannot be fully met; or
- it is a project that has demonstrated that all ESD devices have been implemented to the MEP, at which point, as a last resort, structural practices will be considered.

### 9.3 Approval Authority

All SWM facilities permitted by the County are reviewed and approved by DPIE before a permit is issued. In addition, basins and ponds may require approval from PGSCD, NRCS, or MDE Dam Safety Division for design purposes. If the proposed facility location affects Federal,

State, County, or regulatory agency properties, the applicant will be required to adhere to any special considerations imposed by that entity.

Applicants are responsible for ensuring their design complies with all approving agency review criteria and that the information submitted to those agencies is the same. The following are the approval authorities for SWM facilities in the County.

### 9.3.1 DPIE

All SWM facilities in the County require approval from DPIE, except for projects in the City of Bowie or State and Federal projects. Additional agencies may participate in the review or approval of SWM facilities, as described in the following sections.

### 9.3.2 PGSCD

The PGSCD, the NRCS, and the County have a three- way agreement concerning technical plan review of County permitted SWM ponds. The latest Memorandum of Understanding (MOU) was updated in July 2014.

PGSCD delegates its review of “small ponds” , with regard to dam safety, in certain instances. In accordance with State law, PGSCD will provide final approval of small ponds based solely on the County review: small ponds designated as Class “A” (low hazard), tributary areas of less than 200 acres, dam height of less than 15 feet (measured from the lowest point on the top of the dam to the lowest point on the upstream toe), and small ponds with principal spillways less than or equal to 48 inches in diameter. This approval includes weir structures where the design storm height does not exceed 5 feet. Ponds larger than the delegated County limit and up to PGSCD’s limit will still be reviewed by the County, with a final review and approval by PGSCD.

The approval by this agency is limited to dam safety and classification versus SWM requirements.

Farm ponds do not require DPIE approval and are regulated solely by PGSCD. See the current version of the *PGSCD Reference Manual* for additional information.

### 9.3.3 MDE

According to the Annotated Code of Maryland, Environmental Article 5-503, embankments with tributary areas 640 acres or greater, dam height 20 feet or greater (measured from the lowest point on the top of dam to the lowest point on the upstream toe), or Class B (intermediate), or Class C (high) hazard dams, must be approved by the MDE Dam Safety Division. The approval by MDE is limited to dam safety issues and classification, not SWM requirements, except for State/Federal projects, in which case MDE also reviews the project for SWM requirements.

### 9.3.4 Municipalities

All projects within the City of Bowie require City of Bowie approval for SWM facilities. These projects do not require DPIE approval.

### 9.3.5 M-NCPPC

All SWM facilities that extend onto land owned by M-NCPPC require review and approval by the M-NCPPC DPR to ensure compatibility.

### 9.3.6 Federal and State Projects

All SWM facility projects proposed on Federal or State-owned land require MDE approval. These projects do not require DPIE approval, except for evaluations of 10-year and 100-year flood control and existing downstream flooding and erosion.

## 9.4 Submittal Requirements

The SWM Design Plan must contain all necessary technical information to support the design. This includes the approved SDCP and SDP, if applicable. It could also include the Drainage Area Map, Final Design Plan and profiles, hydrologic/hydraulic computations, and structural computations and drawings for non-standard structures. In addition, a geotechnical report with soil analysis (utilizing Unified Soil Classification), may also be required.

The SWM Design Plan submittal package must include applicable design review checklists and all other pertinent documents to support the design of structural practices. The design consultant shall select the appropriate checklists for the types of devices proposed and include these with the submissions. Finally, the latest version of the PGSCD *Soil Erosion and Sediment Control - Pond Safety Reference Manual* provides additional design guidance and criteria for any facility subject to a dam safety review. See permit submittal and design review checklists included on the DPIE website for additional information.

## 9.5 Maintenance Considerations/Responsibilities

Section 5.2.5 of this manual defines standards for public versus private storm drain and SWM systems. Prior to plan approval of private storm drain and public/private SWM facilities, the Owner will be required to sign and record a Declaration of Covenant. A sample Declaration of Covenant is included in Appendix 11-7.

Owners of both publicly and privately maintained facilities will be required to maintain those facilities, and will be subject to periodic inspection and subsequent enforcement by the DOE according to County Code Sec. 32-196. This requires an inspection after the first year of acceptance of completion (i.e., after release of permit by County) and at least once every 3 years thereafter.

## 9.6 Structural BMPs - General Design Criteria

Structural BMPs are the last resort to meet the ESD to the MEP requirements. They require additional design measures, as they generally have larger drainage areas than non-structural measures. They also may be applicable under other circumstances such as site, groundwater, or soil constraints and may be more applicable to redevelopment projects. Since they are able to provide  $CP_v$  for larger areas, different design considerations will apply. The following information is presented to the design consultant for consideration when preparing design drawings.

### 9.6.1 H&H Computations for Stormwater Management

The preparation of H&H computations for a storm water pond is important because they provides documentation that the release rates for the design storms are in compliance with the goals established under the SDCP.

#### 9.6.1.1 Guidance - Prior Approvals:

SWM measures will be designed to achieve the requirements stated in the approved SDCP or SDP.

#### 9.6.1.2 Methodology:

Computations supporting the design are to be submitted using NRCS TR-55, TR-20, or other methods approved for use by DPIE, MDE, or PGSCD as appropriate. The requirements for computations are in the design review checklist available on the DPIE website

#### 9.6.1.3 Pre-Development Condition:

To compute pre-development runoff for projects requiring 10- or 100-year attenuation, all RCNs shall be calculated based on onsite areas as meadow in good hydrologic condition. (This shall include non-forested areas such as agricultural land, and existing forested areas including woods with good hydrologic conditions.

For re-development projects, the RCN shall be based on meadow in good hydrologic condition for all existing non-forested areas including pervious and impervious areas, and for existing forested areas, woods with good hydrologic conditions. For the 10-year storm, offsite areas shall be based on present development conditions, and for the 100-year storm analysis, offsite areas shall be based on ultimate development. See the *2000 Maryland Stormwater Design Manual, Volumes I and II (MDE, 2000 and 2009 (Maryland Design Manual) Sections 2.4 and 2.5 for additional information.*

#### 9.6.1.4 Post-Development Conditions:

To compute post-development runoff for projects requiring 10- or 100-year attenuation, all lands on the site shall be assumed to be fully developed to current Master Plan zoning. For the 10-year storm, offsite areas are based on

present development conditions. For the 100-year storm analysis, offsite areas shall be based on ultimate development. For purposes of sizing principal and emergency spillways, the entire contributing watershed shall be based on ultimate development conditions.

#### 9.6.1.5 Downstream Analysis:

When the principal spillway connects to an existing storm drain system, it is the applicant's responsibility to ensure that the hydraulic effects of the existing storm drain are analyzed. A detailed HGL analysis of the downstream storm drain system shall be provided. This analysis shall include conveyance, system losses, and HGL in the system for the 2-, 10-, and 100-year storms, as needed to develop a tail water condition at the proposed structural BMP.

#### 9.6.2 ESD<sub>v</sub>, WQ<sub>v</sub>, CP<sub>v</sub> sizing

If structural BMPs are required to supplement ESD devices, these structural BMPs shall provide any remaining SWM volume, after accounting for the volume controlled by the ESD devices. The method of sizing the additional management required in structural BMPs is to be calculated as follows (methodology obtained from MDE Environmental Site Design Process and Computations July 2010):

Step 1: Determine total volume treated by ESD devices = ESD<sub>v</sub> achieved

Step 2: Calculate rainfall captured and treated by ESD devices

$$P_E \text{ achieved} = (12 \times \text{achieved}) / (R_v \times A)$$

Step 3: Using Table 5-3 in the MDE manual, determine reduced RCN, by inserting the developed % Impervious and the P<sub>E</sub> achieved

Step 4: Calculate S and Runoff Q<sub>E</sub> resulting from reduced RCN

$$S_{RED} = (1000 / RCN_{RED}) - 10 \text{ (use reduced RCN from step 3)}$$

$$Q_E = (2.7 - 0.2 \times S_{RED})^2 / (2.7 + 0.8 \times S_{RED})$$

Step 5: Calculate Volume of Runoff resulting from reduced RCN

$$V_{RED} = Q_e \times A / (12)$$

Step 6: Calculate Volume of Runoff resulting from pre-development RCN

$$S_{PRE} = (1000 / RCN_{PRE}) - 10$$

$$Q_E = (2.7 - 0.2 \times S_{PRE})^2 / (2.7 + 0.8 \times S_{PRE})$$

$$V_{PRE} = Q_E \times A / (12)$$

Step 7: Calculate additional management required in structural BMPs

$$V_{\text{structural}} = V_{\text{RED}} - V_{\text{PRE}}$$

For projects that have no ESD treatment, such as a project that meets the grandfathering requirements, a facility must be sized to meet MDE Chapters 2 and 3 sizing methods ( $WQ_V$  and  $CP_V$ ).

### 9.6.3 Overbank Flood Protection (10-Year) Sizing

If 10-year control is required by the SDCP approval, the structural SWM BMPs must be sized to attenuate the increase in flows due to development for this storm event. The design consultant must provide calculations for pre-development  $Q_{10}$ , post-development  $Q_{10}$ , and post-development  $Q_{10}$  with the controls in place. The design consultant may use the reduced curve number calculation method outlined in the following MDE paper to calculate the post development  $Q$ .

#### [Addressing Quantity Control Requirements](#)

### 9.6.4 Extreme Flood Protection (100-Year) Sizing

If 100-year control is required by the SDCP approval, the structural SWM BMPs must be sized to attenuate the increase in flows due to development for this storm event. The design consultant must provide calculations for pre-development  $Q_{100}$ , post-development  $Q_{100}$ , and post-development  $Q_{100}$  with the controls in place. According to MDE, only a green roof and permeable paving may use the RCN values in MDE Chapter 5.

The design consultant has the option of comparing peak flows based on timing. It will require an analysis certified by a professional engineer that documents the timing differences.

### 9.6.5 BMP Summary Table

A BMP summary table shall be provided on all SWM plans. See Appendix 10-1 for example. The form shall also be submitted in an Excel format at SDCP approval and Permit approval.

### 9.6.6 Easements

Easements or dedications are required for public facilities such as storm drain, SWM, or ESD<sub>V</sub>, if they are located outside of the public road right-of way or County-owned property. Declaration of Covenants for maintenance (commonly referred to as maintenance agreements) are required for private facilities. (See Chapter 11 for easement information and Appendix 11-7 for a sample Declaration of Covenant.)

## 9.7 Structural BMPs

MDE has defined structural BMPs as any facility that meets the criteria of Chapter 3 from the *Maryland Design Manual* and as referenced in County Code Sec. 32-179(b) (1). These include the following practices.

- A. SWM ponds
- B. SWM wetlands
- C. SWM infiltration
- D. SWM filtering systems
- E. SWM channels

### 9.7.1 Ponds

Construction of an SWM facility to provide peak flow reduction has been an accepted practice for many years. Accordingly, many technical, functional, safety, and aesthetic considerations are now required for the implementation of the design. DPIE and PGSCD collaborate on the approval of a facility that meets the definition of an “embankment form MD-378.” The following are many of the requirements to be included with the design and computations for a storm water pond.

#### 9.7.1.1 Definition and Applicability

Ponds are defined by MD-378 as “A water impoundment made by constructing a dam or an embankment, or by excavating a pit or dugout.” In this standard, ponds constructed by the first method are referred to as embankment ponds, and those constructed by the second method are referred to as excavated ponds. Ponds constructed by both the excavation and embankment methods are classified as embankment ponds if the depth of water impounded against the embankment at the principal spillway storm design high water elevation is 3 feet or more. The 3 feet shall be measured from the low point on the upstream toe of the embankment to the design high water.”

#### 9.7.1.2 Pond Spillway Sizing and Freeboard

- A. All “urban” ponds with only a principal spillway must pass the 100-year storm with 2 feet of freeboard to the top of the dam, and any opening 6 inches or smaller in any direction, is considered blocked. In addition, the storage to an opening less than 6 inches in height is assumed non-effective when determining the 100-year WSEL. If an emergency spillway is provided, the minimum freeboard requirement is 1 foot with at least 2 feet to the emergency spillway elevation. For other criteria and for larger facilities, refer to MD-378 and the *PGSCD Reference Manual* for additional guidance. For the purpose of land



development, ALL ponds approved by the County are to be designed using “urban” criteria.

- B. When 100-year attenuation is required, care shall be taken to ensure the 100-year overflow path is directed to the SWM facility. This includes storm drain conveyance system overflow and overland conveyance. The overflow path may need to be contained within a surface drainage easement recorded through DPIE.
- C. When a SWM facility passes the 100-year storm through the principal spillway with no emergency spillway and directly connects to a storm drain, the system is designed to the capacity of the downstream storm drain system for the SWM facility 100-year storm flow. See Section 8.3.2.G for further guidance on required downstream storm drain HGL analysis.

### 9.7.1.3 Dam Classification

Aboveground facilities may be either embankment or excavated facilities. The preparation of any design for these facilities will require compliance with the latest version of MD-378. The information in this section supplements requirements from the MDE 2000 *Maryland Stormwater Design Manual Volumes I and II (Maryland Design Manual)* Chapter 3 for types P1 – P5 and W1 – W4 in Sections 3.1 and 3.2.

MD-378 requires determination of dam safety classification. The dam classification of a dam is the responsibility of the design consultant and is subject to review and concurrence by the approving authority. PGSCD may only approve Class A dams. However, the applicant has the option of submitting to MDE for approval of the dam classification since the procedures used to determine the dam class can yield different results.

The County policy is to **NOT** accept a facility that is a Class B or C embankment because of the potential downstream hazard to properties, unless approved by the Director. If a Class B or C facility is approved, proper downstream notification procedures required by MDE must be included as part of the design plan. The plan will need to address the required coordination with County/State emergency service providers. See the MDE website for information about the Dam Safety Program and requirements.

[Maryland's Dam Safety Program](#)

### 9.7.1.4 Permanent Pools - Unacceptable Locations

Facilities with permanent pools may not be located in areas that discharge to Class III or IV Trout Waters identified in COMAR 27.08.02.08, Stream Segment Designations. In Prince George’s County, this would only apply to Northwest

Branch and all tributaries above East-West Highway (Route 410) as well as Paint Branch and all tributaries above I-495.

#### 9.7.1.5 Pond Buffers

Generally, a 50-foot-wide vegetative buffer zone, must be provided where residential lots are in close proximity to the basin. If ponds are adjacent to non-residential areas, the buffer may be reduced to 25 feet. The buffer shall be measured from the 100-year design high water elevation and embankment limits to the adjacent lot line. This area will provide a required physical vegetative barrier to prevent open access to the basin. This buffer area may be planted using landscape material outlined in Appendix 9-1 or may be left in a natural state. If the buffer area is excavated, it must be graded to a slope of not less than 2.5%. No residential lots are to be allowed in the buffer area.

#### 9.7.1.6 Pond Safety Benches and Fencing

Ponds shall be designed in accordance with the applicable safety standards and not rely on fencing for safety. An owner may install 4-foot-high fencing around a private pond, but such fencing may not be used in lieu of adherence to pond safety design standards and guidelines. The following criteria shall be met.

Dry Ponds - The following safety features are to be incorporated into the design of a dry facility.

- Provide a 10-foot-wide bench 1 to 3 feet above the extended detention elevation (1-year storm) suitable for access by maintenance and emergency vehicles and as a safety feature. This bench should have a cross slope of 2 to 5% toward the bottom of the facility. The bench may be stabilized with grass after an all-weather access road to the riser structure has been provided from a public road or other paved access.

Wet Basins - The following safety features are to be incorporated into the design of a wet basin:

- A 10-foot-wide bench 1 to 3 feet above the normal pool (if possible) and at least 1 foot above the extended detention elevation (1-year storm), if applicable, suitable for access for maintenance and emergency vehicles and to serve as a safety feature. This bench should have a cross slope of 2 to 5% towards the normal pool. The bench may be stabilized with grass after an all-weather access road to the riser or weir structure has been provided from a public road or other paved access.

- For wet ponds deeper than 2 feet, an underwater safety bench a minimum of 5 feet wide and a cross slope of 0 to 5 % into the normal pool are required. This bench shall be located 6 inches to 12 inches below the normal pool elevation and extend around the entire perimeter of the pool, except at the control structure. This bench area shall be planted with wetland vegetation to act as a barrier to restrict access. See Appendix 9-2 and Appendix A and Table A.4.1 from the *Maryland Design Manual*.
- Warning signs shall be provided for wet facilities. The typical detail in the DPIE standard detail will be used. See Appendix 9-3.

24-hour Extended Detention Basin - These basins shall incorporate the same safety features as wet basins with the following exceptions:

- The 5-foot-wide safety bench sloped at 2%- 5% shall be placed 6 to 12 inches below the designed extended detention elevation (except for natural contour ponds that would require clearing of trees and natural vegetation).
- When landscaping the basin, plants that are tolerant of wet conditions may be planted within the extended detention ponding area.
- Benching will not be required for basins with an extended detention depth averaging less than 2 feet across the bottom.

Forebay - The following general requirements shall be followed:

- For a forebay deeper than 2 feet, a 5-foot-wide bench with a maximum of 2 to 5% cross slope set at depth of 6 to 12 inches shall be placed below the permanent pool elevation surrounding the forebay area. The bench may be used for wetland plantings.
- Safety and wetland plantings must be considered in the design.

Special Consideration

- For large multi-use facilities where recreation is planned, additional safety features may be required as necessary to make the facility suitable for the intended use.

#### 9.7.1.7 Pond Drains

Generally, if the design includes a permanent pool, a pipe controlled by a valve capable of draining the pond (to a maximum water depth of 2 feet for the area

that cannot be drained by gravity) within a 24-hour time period shall be provided. A sump pit may be required for future maintenance considerations. Exceptions may be made for shallow marsh ponds where outfall conditions do not permit a pond drain to be installed, and where adequate safety measures outlined in Section 9.7.6 are taken.

- A. Valve controls with an extension to the top slab.
- B. To reduce the possibility of clogging the drain pipe openings at the riser, incorporate redundancy, such as gabion baskets to collect sediment and keep debris away from the opening.
- C. A small concrete pad such as County Standard SD 160.0 or similar is required to provide stable ground at the end of the low flow pipe or drain.

#### 9.7.1.8 Pond Low Flow Channels

For dry basins passing a continuous stream flow, the vegetated floor shall have a 1% minimum slope to direct the flow toward the riser area. A riprap, sodded pilot channel or French drain may be required for larger facilities to prevent erosion of the facility. Appropriate vegetation should be considered for larger facilities along the pilot channel to allow for temperature reduction or constant water flow.

#### 9.7.1.9 Utilities through Embankments

SWM embankment locations must be free of utility crossings except as noted herein and permitted by DPIE and PGSCD and acceptable to WSSC for water or sewer facilities.

- A. Proposed dams that are also used as roadway crossings may have utility lines traversing the dam parallel to the alignment of the roadway. The utility lines must be installed without gravel bedding in accordance with MD-378.
- B. If possible, existing utilities located in the proposed dam embankment area should be removed and re-routed outside the embankment and core trench area.
- C. All pipes through the dam shall have an inside diameter of 1-1/4 inches. Pipes/utilities not parallel to the axis of the dam shall meet the principal spillway requirements such as, but not limited to, anti-seep collars or filter diaphragms and embankment soils.
- D. According to the *2008 WSSC Design Manual*, the following criteria must be met:

- Sanitary sewer manholes within the SWM pool 2-year design storm flood limit must be removed or relocated.
- The existing sanitary sewer pipeline within the SWM 2-year design storm flood pool must be rehabilitated to eliminate all infiltration points.

In addition, existing sanitary sewer manholes within the SWM 10-year or 100 – year design or flood limits should be rehabilitated as necessary to eliminate all significant inflow/infiltration points.

#### 9.7.1.10 Ponds and Pipe Outfalls into Ponds

For basins with maintenance benches, all storm drain outfall inverts shall be located at or above the permanent pool elevation, unless otherwise approved by DPIE. If a waiver is requested, the outfall pipe invert may be depressed up to 2 feet or 1/2 the pipe diameter, whichever is less below the permanent pool, if it is not feasible to raise the storm drain pipe system. See Appendix 9-4 for examples of A through C below.

- A. The bench may be elevated to account for the pipe minimum cover for the pipe crossing to maintain 1 foot of cover over the top of the pipe. A maximum of 15% slope for vehicular access for the bench will be allowed. If no vehicular access is proposed, a steeper slope is acceptable with approval by the County.
- B. The access road may also cross a gabion mattress or similar type of material from an outfall. Crossing riprap with an access road is **NOT** acceptable.
- C. For inflow pipes into a wet pond, riprap (if the slope is less than 10%) and gabion mattress (if the slope is steeper than 10%) shall extend down the slope of the wet pool and at least 10 feet along the bottom of the pond. The width of the outfall shall be at least 10 feet wide for pipes 15 to 36 inches and 15 feet wide for pipes greater than 36 to 72 inches. For a larger pipe size, additional width or length may be required.

#### 9.7.1.11 Pond Topography and Slopes

SWM ponds and storm water wetlands should be designed utilizing 2-foot maximum contour interval topography and a maximum of 1 inch=30 feet plan view.

All slopes including the dam embankment are to be a minimum of 3 feet horizontal to 1 foot vertical maximum (3:1) both upstream and downstream. Any grading that disturbs the back or side slope above the top of the dam shall comply with the County grading ordinance based on the property zoning. For mixed-use zoning with any residential property, the back or side slope above the top of dam elevation shall be 3:1. Undisturbed slopes do not need to be modified. If the facility is located on M-NCPPC

property, the side slope on the inside of the facility shall be 4:1 or flatter where excavation occurs. The embankment may be 3:1 for both sides. See additional information in Appendix 9-5 for slopes, location of facilities, or other requirements when locating a facility on M-NCPPC property.

#### 9.7.1.12 Pond Fore bays

A sediment forebay shall be required at major inflow points. A major inflow point is defined as greater than 10% of the drainage area to the facility or 4 acres, whichever is smaller.

- A. A forebay shall be sized to contain at least 10% of the  $WQ_v$ ,  $CP_v$ , or other required volume if no upstream  $ESD_v$  devices are present.
- B. The forebay storage volume counts toward the total  $WQ_v$  requirements.
- C. No forebay is required if the total drainage area to the facility is less than 4 acres.
- D. A defined barrier should be provided between the forebay and the main body of the pond.
- E. Earthen forebay weirs that will be submerged in a pond permanent pool are not permitted. All submerged weirs placed below the permanent pool must be constructed of gabion, stone, or similar inert material.
- F. A gabion weir or equivalent will be required to separate the forebay from the main body of the pond. If a gabion is used, the wire, coating, and stone shall meet the latest version of the MSHA Standard Specifications for Construction and Materials Sections 901 and 907.
- G. Exit velocities from a forebay shall be non-erosive.
- H. The forebay shall be drained by gravity if it is not submerged in a permanent pool that would be drained as part of the main pond drain pipe.

#### 9.7.1.13 Pond Core Trench and Embankment

All dams require a minimum of 4 feet deep and 4 feet bottom width core trench below the existing ground or below bottom of pond in accordance with MD-378 except as noted in A below. The side slopes shall be 1:1 along the dam centerline and 1:1 along the pipe profile for fill embankments.

- A. If determined by the Geotechnical Engineer in the geotechnical report, the core trench may need to be extended to reach suitable material as determined in the MD-378. Plans must clearly indicate the limits of the core trench in plan and profile.

- B. The core trench should be located in the center of the dam. In case of unavoidable conflicts, the center of the core trench may be located upstream of the center of the dam.
- C. If the facility is an excavated embankment or if the principal spillway is to be replaced, the side slope along the embankment centerline shall be 2:1 and shall be keyed into the existing ground. The side slope for the core trench placed along the pipe profile shall be 1:1.
- D. Soil boring locations will be shown on the plan view, profile, and cross section of the centerline of dam.
- E. Fill material for the center of the embankment and cutoff/core trench shall conform to Unified Soil Classification GC, SC, CH, or CL.
- F. Off-site borrow or spoil areas must have an approved and active sediment control plan in accordance with PGSCD Reference Manual and shall be referenced on the SWM plan.

#### 9.7.1.14 Pond Riser Structures

Riser structures must be reinforced concrete either pre-cast or cast-in-place. The use of concrete masonry unit or brick are **NOT** permitted. The following criteria shall also be considered:

- A. Cast-in-place riser designs will require structural review prior to plan approval.
- B. Precast structures will require shop drawings, which may be approved after plan approval but prior to fabrication. The shop drawings will be submitted to the design consultant of record for verification of dimensions. After verification, the design consultant shall submit the drawings to DPIE for approval.
- C. Flotation computations shall be provided for all riser structures, to ensure that the weight of the riser is 1.2 times or greater than the buoyant force.
- D. A concrete top slab is required unless a waiver is requested and approved by the County. If a waiver is approved, the drop inlet spillways are to have adequate anti-vortex devices. An anti-vortex device is not required if weir control is maintained in the riser through all flow stages prior to orifice flow or if barrel control is achieved.
- E. The top of the riser 100-year weir opening shall be set above the blocked 100-year WSEL, if there is a top slab.

- F. The riser joint connection shall be watertight and sealed by using proper water stops. In addition, straps or other means shall be installed to prevent the structure from separating.
- G. Pipe connections with the riser shall be watertight; therefore, a concrete collar is required for all pipe openings into the pre-cast riser structure.
- H. The low flow pipe or orifice opening shall be no smaller than 6 inches in diameter. If a smaller orifice area is required, provide a 6-inch or larger cap with the correct orifice size drilled or cut into the cap. The orifice opening may be no smaller than 3 inches in diameter.
- I. The low-flow orifice must be protected by a trash rack or hood that can prevent the orifice from clogging.
- J. The riser design computations shall account for tail water conditions for downstream conditions and in the riser. This may require submerged weir or orifice evaluation for the riser openings. See Appendix 9-6 for an example.
- K. Steps or a ladder shall be provided on the inside of the riser to safely allow access to the bottom of the structure. Pipe openings cannot be used as steps.
- L. The riser shall be located in the embankment so that dry access from the access road/maintenance bench is possible if the 1-year opening is clogged. See example in Appendix 9-7.

#### 9.7.1.15 Pond Trash Racks

Stormwater management riser structure openings shall be protected from clogging by trash racks.

- A. The dimensions of trash rack openings shall be no larger than 1/2 the dimension of the barrel conduit diameter or a smaller dimension for a weir or orifice opening. The minimum dimensions will not be less than 6 inches. For openings smaller than 12 inches, provide hoods, perforated pipe with stone filter, and other materials as necessary.
- B. See *Maryland Design Manual* pages 3.13 and 3.14 for additional information on non-clogging low flow openings.
- C. For ponds located in-stream, the trash rack on the low-flow opening shall have a minimum of 6 times the cross-sectional area of the low flow opening.



- D. For ponds with only storm drain inflows, the trash rack area may be reduced to a minimum of 3 times the area of the low-flow opening.
- E. The reinforcing bars used in the fabrication of a trash rack shall be sized according to the design. However, in no case shall reinforcing bars be less than #6 rebar.
- F. All trash racks shall be hot dipped galvanized to inhibit corrosion.
- G. Vertical bars shall be located outside of horizontal bars.
- H. The trash rack shall project out a minimum of 8 inches from the riser or weir wall at the bottom (trapezoidal shape is acceptable with 6 inches minimum extension at the top).
- I. The bottom of the trash rack for the main weir shall be a minimum of 8 inches below the weir crest.
- J. The trash rack shall be permanently attached to the riser structure by expandable bolts or equivalent. Provide sufficient space above the top of the weir opening so the trash rack is not bolted to the riser top slab.
- K. Generally, for basins with permanent pools, provide a hood or inverted elbow over the orifice opening to prevent oils and other floatable objects from leaving the pond. The hood should extend at least 12 inches below the surface of the permanent pool. Adequate clearance from the ground to the bottom of the hood shall be maintained to avoid blockage (a minimum of 1 foot).
- L. For low-flow pipes located in a dry facility, the trash rack shall be designed with a hinge to provide easier maintenance. See Appendix 9-8 for an example.

#### 9.7.1.16 Pipe Outfalls

Outfall pipes through the embankment must be round, RCP with rubber gasket joints using ASTM C-361 RCP. A cast-in-place box culvert with no gravel bedding is an acceptable alternative. Additional requirements for the appurtenances of the outfall structure are as follows. A sample barrel and riser profile, embankment section, and emergency spillway cross section and profile may be found in Appendices 9-9 to 9-11.

- A. Outfall pipes (principal spillway) require a concrete cradle within the embankment area.
- B. For a long pipe outfall reach, the concrete cradle may be stopped at the theoretical toe of embankment provided a manhole is added.

- C. Anti-seep collars or filter diaphragms are to be provided in accordance with MD-378 requirements for sizing and location. At least one collar or the filter diaphragms must be located upstream of the core trench.
- D. Anti-seep collars shall be placed a minimum of 2 feet from pipe joints.
- E. The first pipe joint must be located within 4 feet of the inside face of the riser.
- F. For all SWM basins, the assumed phreatic line shall be drawn at a 4 horizontal to 1 vertical slope from the intersection of the higher of the sediment control basin 10-year or SWM 10-year WSEL for the embankment to the invert of the outflow pipe.

#### 9.7.1.17 Pond Weir Structures

If an overflow weir is used as the principal spillway, the following criteria will apply.

- A. The weir wall shall extend to the design top (settled) of the dam and shall be embedded a minimum of 5 feet horizontally on each side into the embankment at the top of the dam.
- B. In the event the weir wall plus foundation above the footer is greater than 10 feet, the embedment shall be a minimum of 1/2 the height of the wall.
- C. For purposes of dam safety analysis, the weir elevation that passes the 100-year storm flow may be used to establish breach height, instead of the 100-year WSEL, provided that the weir opening is at least 8 feet wide.
- D. The riprap outfall for a weir structure shall consider the length of a hydraulic jump from the overflow before starting the required length of riprap that is used to reduce the velocity to less than 5 fps.
- E. Structural computations for the weir wall shall also address the overturning movement of the weir wall based on the WSEL at the top of dam.
- F. Weir walls shall provide a concrete splash pad or equivalent on the downstream side of the wall. This splash pad shall be an integral part of the weir wall, and designed to extend at least 3 feet beyond the face of wall or the upper nappe of the weir overflow for the 100-year storm, whichever is longer.

#### 9.7.1.18 Pond Access Roads

A 10-foot-wide access road shall be provided from the existing public right-of-way or other paved access to the riser or weir wall structure, forebay, and the

inside perimeter of the pond. Provide turnarounds near the end of the access road if the access road cannot be extended around the perimeter of the pond.

- A. Generally a 25-foot-wide easement is required for the access road from the public right-of-way or equivalent paved area when the access road is located between residential lots. A narrower width may be acceptable for flatter slopes, but it must always be at least 15 feet wide. Access roads and access easements cannot be located on residential lots.
- B. The access road paving section shall meet the typical paving section in DPW&T Standard 100.07 for Urban Secondary Residential Road or grass pavers/rings when located adjacent to residential lots. For residential areas, once past the rear lot line, an asphalt section meeting the above standard shall be provided.
- C. The access road beyond the riser or weir wall structure around the perimeter of the pond may be grass or gravel.
- D. If gravel (ASTM C-33 Size #57) is used, it shall be at least 6 inches thick. Recycled concrete at the surface is not acceptable, but may be part of the sub-grade. Geotextile fabric meeting MSHA specification 921.09.01 separating the gravel from the sub-grade shall be provided.
- E. A modified commercial driveway apron will be placed at the public road for access. A minimum 12-foot-wide galvanized gate meeting County standard SD 83.0 is to be provided. The gate should be located to discourage unwanted access, yet be unobtrusive. Landscaping is also encouraged to provide a buffer between the pond access road and nearby lots.
- F. The access road shall be designed with a maximum of 15% running slope for asphalt paving and 10% for grass, gravel, or other materials. The maximum cross slope shall be 4%.
- G. Landscaping along the access road adjacent to lots is encouraged to buffer the access road impact to nearby lots. The designer shall ensure that the landscaping is in compliance with M-NCPPC landscaping guidelines.

#### **9.7.1.19 Pond Riprap Outfall**

To minimize erosion around the end wall, riprap placement shall be tied into the top edges of principal spillway end wall. Riprap size, width, and length shall comply with Section D-4 of the *2011 Maryland Standards and Specifications for Soil Erosion and Sediment Control*.

#### **9.7.1.20 Pond - No Woody Vegetation/Clearing Zone**

No trees or woody plants are permitted on the fill embankment. The zone where no woody vegetation is permitted includes the embankment, the core trench, areas within 15 feet of the toe of embankment, areas within 25 feet of the control structure, the emergency spillway, and the maintenance access road. For the purpose of an excavated pond, the woody vegetation may not be located within 25 feet of either side of the outfall pipe. All other areas (except an emergency spillway) may be planted with woody vegetation.

#### **9.7.1.21 Pond Stabilization and Landscaping**

See *PGSCD Reference Manual*, pages VIII-14 to 19, for MD-378 specifications to be shown on the SWM plan.

The last 6 inches of the embankment top and side slopes fill shall consist of topsoil per MD-342. Grass cover shall also meet the latest MD-342 specifications, which are shown on the approved Final Grading, Erosion and Sediment Control Plan.

A landscape plan for the SWM facility is part of the overall approval and shall comply with the *M-NCPPC 2010 Landscape Manual* for native vegetation requirements. Trees or shrubs may not be planted on the embankment or within the non-woody buffer identified on the design plan. Trees may be planted outside the SWM non-woody buffer area or the internal area of the SWM basin.

For wetland plantings, see *MDE 2000, Stormwater Design Manual (Maryland Design Manual)* Sections 3.2.1 to 3.2.5 and Appendix A for additional information.

#### **9.7.1.22 Pond Geotechnical Information**

A geotechnical analysis is required for all retention and detention basins. The analysis to be prepared by a Geotechnical Engineer shall be in accordance with MD-378 and the *PGSCD Reference Manual*, page II-7 and pages III-16 and 17.

#### **9.7.1.23 Dam Breach Analysis**

A dam breach analysis and dam hazard classification is required for all MD-378 ponds. The preliminary dam classification will be established by a dam breach analysis submitted at the Environmental Site Development Sediment Control Plan stage for review by PGSCD. The computations in the final report will reflect final embankment design, and a final dam breach analysis shall be provided in accordance with requirements stated in MD-378 and the *PGSCD Reference Manual*. PGSCD will verify the preliminary dam classification and dam breach analysis at the Final Grading, Erosion, and Sediment Control Plan approval stage.

### 9.7.1.24 Pond Retrofit Guidance

The retrofitting of existing ponds presents an opportunity to meet the current SWM quality control and/or quantity control requirements. Any modifications to the riser openings or height, weir wall, or emergency spillway may invalidate a previous plan approval or introduce other dam safety issues that are not currently present.

Before proceeding with a retrofit design, the following actions need to be addressed, which may require a meeting with the dam safety approving authority, i.e., PGSCD or MDE:

- A. Examine and evaluate the riser, barrel, and all joints to determine if they are still sound and not leaking.
- B. Obtain copies of as-built data including as-built geotechnical reports from PGSCD or DPIE. If the pond is older than 5 years, PGSCD may only have a copy of the as-built drawings.
- C. If no geotechnical report is available, it is likely soil borings will be required to verify dam material composition.
- D. Perform an operations and maintenance (O&M) inspection of the facility and identify any deficiencies. The inspection should follow the current O&M procedures, which are available in the *PGSCD Reference Manual*. Of particular interest would be the absence of both piping on the downstream side of the facility and woody vegetation on the embankment as defined by MD-378.
- E. A cursory dam breach analysis is necessary if the design proposes increasing the design WSEL. This will be used to determine whether the dam classification is correct and additional study is warranted.
- F. For larger facilities (i.e., with drainage areas greater than 200 acres), a meeting with PGSCD and/or DPIE is recommended to review the proposed changes. After determining that the concept to revise the facility is valid, the following information will be required at plan submittal:
  1. Updated hydrology to meet the latest requirements for ultimate zoning and  $T_c$  within the contributing drainage area.
  2. Revised stage - storage - discharge table based on actual elevations, not design elevations. New computations are required, not just copies of old computations. They must also reflect the as-built elevations for the control structure and current topography.

3. The MD-378 specifications valid at the time of the plan approval shall be included on the plan.
- G. If an as-built geotechnical report is not available, soil borings in the embankment to verify that proper materials were used and compaction achieved may be required.
- H. Provide soil boring at the emergency spillway to verify the dam was constructed on existing ground.
- I. If the facility is currently or proposed as a high hazard facility, update or prepare the emergency action plan. The County prefers to avoid/prohibit high hazard facilities, so every effort to reduce the hazard will be encouraged.
- J. If the facility has a drainage area greater than 200 acres and the revised plan is approved by PGSCD, it will also require review by NRCS. If MDE previously approved plan, MDE will need to approve the modifications.

### 9.7.2 Structural BMPs - Underground Attenuation Facilities

An underground SWM facility is a device that can provide quantity control to generally meet  $Q_F$  or  $Q_P$  requirements. An underground facility is only acceptable in a private system.

#### 9.7.2.1 Definition and Applicability

Underground attenuation facilities may consist of underground pipes or vault detention. Pipes or vaults may be located below vehicular or non-vehicular areas, and must be a minimum of 10 feet horizontally from other utilities.

- The use of underground detention facilities is an acceptable practice to attenuate the  $Q_P$  and  $Q_F$  storm conditions when required for a new or redevelopment project and proposed in a privately maintained system. Use of this design is considered a structural BMP.
- Underground detention facilities, if proposed in a privately maintained system, are an acceptable practice if used to store storm water runoff as part of a cistern or water harvesting system. This design is considered an acceptable ESD practice for new or redevelopment projects. If designed for rainwater harvesting, it is considered an ESD BMP.
- The use of underground infiltration facilities in the form of perforated pipes or perforated chambers to store and exfiltrate the stored volume is an acceptable practice in limited instances. However, new and redevelopment projects must first demonstrate that other preferred ESD practices are not practical or feasible. It should be noted that new development projects are evaluated stringently against the MEP standard before this practice is considered acceptable, as this and other structural practices are lower on the priority list of acceptable SWM

practices. This practice may be used only if suitable infiltration rates and adequate vertical clearance to the GWT exist at the sited location, and is only permissible in privately maintained systems or County CIP built systems. In the limited instances in which underground infiltration facilities are accepted for use, the overall project must provide at least 1 inch of  $ESD_v$  in other ESD-type BMPs. If this practice is used, it must be sized to store the residual “structural” volume that is not met in other ESD practices.

- Underground detention facilities, in lieu of ESD, are not considered acceptable on new development sites, except in unique situations. These situations may include a site that has contaminated soils, unstable soils (such as Marlboro Clay), or other unusual and unique situations in which infiltration of storm water into the underlying soils would jeopardize the safety, stability, or suitability of the developed or downstream lands. In these instances a combination of structural filtration and structural detention may be the only suitable option for providing SWM.

Underground detention can only be utilized in privately maintained systems.

### 9.7.2.2 Design Calculations

The facility must be sized to provide storage for the required treatment volume, with safe conveyance of larger flows through the facility. The facility must be designed to safely pass, at a minimum, the 10-year storm flow. Where the facility is located below a flow splitter, it must be sized to safely pass whatever portion of the 10-year storm event is delivered via the splitter. The facility design must demonstrate adequate 100-year overflow paths out of the structure without affecting existing or proposed buildings and structures.

The design consultant shall provide the following calculations:

- Stage-storage calculations;
- Stage-discharge calculations;
- Downstream storm drain HGL calculations;
- TR-20 routing to demonstrate attenuation of the design storms (e.g., 10-year, 100-year); pre-development runoff  $Q_s$ , post development runoff  $Q_s$ , and post development runoff  $Q_s$  with SWM provided;
- 
- Environmental site design volume  $ESD_v$  required in accordance with methodology outlined in section 9.6.2;
- Environmental site design volume  $ESD_v$  provided;

- Underground attenuation cannot provide Water Quality Volume (WQ<sub>V</sub>). Computations must include alternate water quality calculations and devices to demonstrate compliance;
- Structural analysis and calculations for vaults and pipes; and
- Flotation computations for storage pipes that demonstrated at least a 1.2 factor of safety.

### 9.7.2.3 Groundwater

In general, underground storage should not be located in areas of shallow groundwater. If it is necessary and groundwater is encountered, additional design information may be necessary, including, but not limited to, Geotechnical Engineer guidance for bedding, flotation, and pipe gauge.

### 9.7.2.4 Geotechnical Analysis

Soil borings must be obtained and geotechnical analysis provided at the location of the proposed detention facility in order to determine the presence and location of fill materials, rock, or groundwater. Borings must extend a minimum of 5 feet below the facility subgrade to verify the bearing capacity of existing soils.

### 9.7.2.5 Specifications and Details

#### 9.7.2.5.1 Control Structure:

- A. The control structure shall be composed of concrete and should be square or rectangular. The minimum inside dimensions of each internal cell must be 4 feet by 4 feet. Structures must be designed for H-20 loading at a minimum. Structural computations, signed and sealed by the designing structural engineer, must be submitted concurrent with the detailed plan review. Direct access to all chambers of the control structure is required.
- B. The overflow weir in the control structure must be designed to safely pass larger flows through the facility.
- C. The low-flow orifice may be no smaller than 3 inches in diameter without specific approval from DPIE. The orifice shall be protected by an expanded metal trash rack, perforated half-round CMP, or equivalent. All trash racks must be removable. The surface area of the trash rack openings must exceed the low-flow orifice area by a ratio of at least 5:1.
- D. The low-flow opening in the control structure must be protected with a trash rack or hood.



#### 9.7.2.5.2 Storage Pipe:

All storage pipes should be circular or rectangular and must be a minimum of 48 inches in height. Elliptical or pipe arch type pipe is not acceptable. Metal, HDPE, or concrete may be used. Crossover connections must be provided between storage pipes, and these must be a minimum of 48 inches in diameter. Pipes may not be closer together than 1/2 the inside pipe diameter, or 3 feet, whichever is greater. This dimension may be reduced when flowable fill is used and it is in accordance with the manufacturer's recommendation. Minimum cover must meet the manufacturer's specifications, based on the design load and considering flotation, where required. Resistivity and pH tests may be required on a case-by-case basis, wherever soil acidity is a concern or if located near a Washington Metropolitan Area Transit Authority rail line.

- A. Metal Pipe: Metal storage pipes must be aluminized, Type 2, and designed for the appropriate loading (pipes may not be less than 14 gauge). Pipe ends must be matched and numbered by the manufacturer. Connecting bands must be corrugated, and sleeve gaskets must be used. All connections must be according to the latest DPIE band detail. A 24-inch connecting band and 24-inch flat neoprene or rubber sleeve gasket, with four rods and lugs, must be used for all pipe connections.
- B. Concrete Pipe: Round concrete pipe must meet ASTM C-76 and rubber gaskets meeting C443 or ASTM C-361. Elliptical pipe meeting C507 with rubber gaskets meeting C443 is also acceptable.
- C. HDPE Pipe: HDPE pipe conforming to ASTM F 2736 for 12- to 30-inch pipes and ASTM F-2648 for pipe sizes between 36 and 60 inches is acceptable for use in underground storage facilities. Concrete manholes must be used at all HDPE pipe connections. Pipe installation must comply with ASTM D- 2321.

#### 9.7.2.5.3 Concrete Vaults

Concrete design shall meet the requirements of ACI 350, Environmental Engineering Concrete Structures, with freezing and thawing exposures. Concrete shall be a type II or IIA cement, with a 28-day compressive strength of 4,500 pounds per square inch (psi) for cast-in-place and 5,000 psi for pre-cast structures. Concrete could also meet the requirements of *Maryland Department of Transportation, State Highway Administration Standard Specifications for Construction and Materials, Section 420, Mix No. 7.*

**9.7.2.6 Pipe and Structure Bedding:**

For concrete pipe, granular bedding must extend a minimum of 6 inches, meeting ASTM C-43 Size #57 below the invert of the pipe or bottom of structure, and shall extend to the spring line or as directed by the manufacturer. CMP pipe shall have at least 6 inches of granular bedding below the invert and select fill to the top of pipe meeting AASHTO Group Classification A1, A2, or A3. Flowable fill is also acceptable, with proper anchorage. For flexible pipe (CMP, HDPE), flowable fill must extend to the top of the pipe.

**9.7.2.7 Access:**

All facility access manholes must have a 30-inch diameter, in accordance with County Standard Details. There must be at least one manhole for every 150 feet of pipe. There must be a minimum of two manholes per pipe run. Where required, access ladders may be used rather than manhole steps, if detailed and if manholes are sufficiently large to accommodate the ladder and normal clearances for access. Manhole covers must be bolted. Manhole access is required at the terminal end of all pipe runs.

**9.7.2.8 Plan and Profile Requirements:**

Provide profile view of entire system with inverts, pipe size, pipe type, and slopes indicated.

**9.7.2.9 No Retention Design:**

Retention underground is not permitted. The system shall be designed to be free draining, with no standing water except for a depressed chamber to trap sediment or grit.

**9.7.2.10 Coordination with Infiltration Trenches:**

Infiltration trenches below the bottom of the attenuation pipes are allowed if no other feasible infiltration location is available because of site constraints. The infiltration trench must use the design criteria for standard infiltration trenches and is only allowed for private systems. The following conditions apply.

- The depth to the ground water table is at least 4 feet below the bottom of the infiltration trench.
- The infiltration rate is at least 0.52 inches per hour.
- The gravel bedding meets the requirement of open graded material such as ASTM C-33 Size #57 stone.

**9.7.2.11 Protection of Metal Surfaces:**

Paint metal surfaces with two coats of battleship gray paint or equivalent.

### 9.7.3 Stormwater Filtering Systems

A storm water filtering system consists of six different types of filters (identified in *Maryland Design Manual* Chapter 3) that meet the requirement of providing  $ESD_v$  if non-structural measures cannot meet all of the requirements. They are as follows:

- F-1 Surface Sand Filter
- F-2 Underground Sand Filter
- F-3 Perimeter Sand Filter
- F-4 Organic Filter
- F-5 Pocket Sand Filter
- F-6 Bio retention

The filters are not designed to meet  $Q_p$  requirements except under unusual circumstances. Filtering practices shall generally be combined with a separate facility to provide these controls.

#### 9.7.3.1 Feasibility and Siting Criteria

**Drainage Area:** The maximum contributing area to an individual storm water filtering system was defined by *Maryland Design Manual* Table 4.4 for the 1 inch storm. With the requirement to provide the remainder of the  $CP_v$  after ESD has been met, an equivalent maximum volume may be used to size the device for redevelopment purposes only. The maximum storage volumes provided below are based on the equation in Section 2.1 of the MDE manual with an assumed 95 % imperviousness.

F-1:	Maximum Drainage Area 10 acres *	32,850 cubic feet (cf)
F-2:	Maximum Drainage Area 2 acres *	6,750 cf
F-3:	Maximum Drainage Area 2 acres *	6,750 cf
F-4:	Maximum Drainage Area 5 acre *	16,475 cf
F-5:	Maximum Drainage Area 5 acre *	16,425 cf
F-6:	Maximum Drainage Area 5 acres *	16,425 cf

\* Drainage area may be larger in some instances, if approved by DPIE.

Setback Distance: The minimum setback or distance from the device to a fee simple lot line shall be 10 feet. In the instance of multi-family, commercial, industrial, and condominium projects with limited lot lines, the device shall be set back a minimum of 10 feet for a structure on a slab or 20 feet for a structure with a basement.

Pretreatment Criteria: Dry or wet pretreatment equivalent to at least 25% of the computed  $WQ_v$  shall be provided prior to filter media.

Distance to GWT: Filtration devices shall be designed to provide a minimum clearance of 4 feet (vertical) between the bottom of the device and the top of groundwater table, as governed by *Maryland Design Manual* Table 4.4.

Public versus Private: Unless otherwise approved by the Director, these facilities may only be used in private systems.

### 9.7.3.2 Design Calculations

The facility must be sized to provide storage for the required treatment volume, with safe conveyance of larger flows through the facility. The facility must be designed to safely pass a 10-year or 100-year storm flow and elevation based on the specific pond exemption criteria from the *PGSCD Reference Manual* noted on pages II-11 and 12. Where the facility is located below a flow splitter, it must be sized to safely pass the portion of the 10-year storm event that is delivered via the splitter. The facility design must calculate and demonstrate adequate 100-year overflow paths out of the structure without affecting existing or proposed buildings and structures.

The design consultant shall provide the following calculations:

- Downstream storm drain HGL calculations, if applicable;
- Environmental site design volume  $ESD_v$  required in accordance with methodology outlined in Chapter 9, Section 9.6.2;
- $ESD_v$  provided;
- For a *Maryland Design Manual* device based on the reduced curve number, calculation up to the 10-year storm event after accounting for ESD devices upstream;
- Channel protection volume  $CP_v$  required, if applicable;
- Channel protection volume  $CP_v$  provided, if applicable;
- Minimum surface area to drainage area requirement;
- Drawdown time;

- BMP summary table ; and
- Hydraulic calculations to demonstrate sizing of outlet structure to convey the 10-year storm to a non-erosive outlet point (e.g., prevent downstream slope erosion). Hydraulic calculations of 100-year storm through facility, if applicable.

### 9.7.3.3 Geotechnical Analysis

Geotechnical analysis and soil borings or test pits shall be provided at all filtration devices, to confirm GWT elevation.

### 9.7.3.4 Specifications and Details

#### 9.7.3.4.1 Pretreatment for Bio retention:

Adequate pretreatment for bio retention systems (F-6) is provided when all of the following are provided:

- 20-foot grass filter strip below a level spreader or optional sand filter layer,
- gravel diaphragm meeting ASTM C-33 Size #57, and
- a mulch layer.

#### 9.7.3.4.2 Soil Media:

The soil media shall conform to the specifications listed in Appendix 10-3 Bio retention Systems (F-6), and shall consist of the following treatment components: a soil media bed that is 2½ to 4 feet deep, a surface mulch layer, and a surface ponding area that is a maximum of 12 inches deep.

### 9.7.3.5 Landscape Criteria

Landscaping is critical to the performance and function of bio retention systems. Therefore, a landscaping plan shall be provided for bio retention areas.

- The planting soil and mulch shall conform to the specifications found in Appendix 10 or MSHA Specification Section 920 under Landscaping.
- The use of native plants is encouraged, but they may not be appropriate in all situations. While no hard planting rule exists, the plants should be a mix of trees, shrubs, and herbaceous materials. Because of the relatively shallow depth of the planting media, it is preferable to plant the surface of the facility with herbaceous materials only.

- Trees and shrubs should be planted at the perimeter of the facility. The number and type of tree and shrub plantings for the system may vary, especially where aesthetics or other considerations such as screening or shading are critical to site development.
- The planting design should anticipate that the mature canopy of trees and shrubs, together with the areas planted with herbaceous materials, should cover at least 85% of the rain garden practice.
- Trees shall be a minimum of 1½-inch caliper, shrubs shall be a minimum of 2-gallon size, herbaceous flowering perennials shall be a minimum 1-quart size, and grasses and grass-like perennials shall be a minimum of 2-inch plugs.
- All plantings shall be in accordance with the Prince George's County landscape guidelines. All landscape plans must be certified by a Registered Landscape Architect. Since the plants are an integral part of the rain garden system, no changes to the approved landscape plan will be allowed unless an alternate plant list, prepared by a Registered Landscape Architect, has been approved by DPIE prior to installation. Since plant availability can change, including an alternate plant list on the landscaping plans is acceptable.
- Filters F-1, F-4, and F-5 may have a grass cover to aid in pollutant adsorption. The grass should be capable of withstanding frequent periods of inundation and drought. See Appendix 9-1 for grass species selection guidance.

#### 9.7.4. Structural BMPs – Infiltration Devices

Infiltration systems have been accepted for use since the mid 1980s . They can be especially effective in recharging groundwater. It is important to verify the type of soil and groundwater table. In addition to the criteria in Chapter 3 of the *Maryland Design Manual*, additional information may be found in the *Maryland Standards and Specifications for Stormwater Management Practices*. This document was published by the State of Maryland in February 1984.

##### 9.7.4.1 Definition and Applicability

Infiltration systems shall be designed in accordance with the *Maryland Design Manual* Section 3.3.

##### 9.7.4.2 Feasibility and Siting Criteria

The following are some design considerations for an infiltration trench.

- Infiltration Rate: The minimum allowable infiltration rate is 0.52 inch per hour.

- Distance to GWT: The minimum acceptable distance from bottom of trench to water table shall be 4 feet.
- Not in Fill: The infiltration trench shall not be placed in an area where the bottom or sides of the trench are in fill or where the area has been compacted by equipment or vehicles.
- Steep Slopes: The infiltration trench shall not be placed on slopes greater than 20%. When the trench is placed on a slope, the trench should be a minimum of 25 feet horizontally away from downstream slopes greater than 20%. An adequate overflow path shall be provided to ensure a non-erosive outfall in the event of clogging.
- Downgrade Properties: The infiltration trench should not be provided at a location that could cause overflow path problems to downgrade properties.
- Marlboro Clay: Infiltration trenches are not permitted in the vicinity of Marlboro Clay or other clays with a high shrink/swell potential as identified in the soil survey or from field investigations. Infiltration structures shall not be placed upstream of Marlboro Clay or other unstable soils.
- Drainage Area: The maximum contributing area to an individual storm water infiltration trench (I-1) shall be 5 acres for a 1-inch storm or a maximum 16,425 cf of water storage for a larger storm event. The maximum drainage area to an infiltration basin shall be 2 acres.
- Siting Criteria near Buildings: Infiltration systems shall be located at least 25 feet horizontally from basement walls, 15 feet from homes with no basements, 50 feet from septic fields, and 100 feet from water wells.
- Clearance to Utility Lines: A minimum of 5 feet of horizontal distance shall be maintained between a utility line and an infiltration trench. No utility line should be placed over, under, or within an infiltration trench.
- Pretreatment Configuration: Surface drainage systems require pretreatment before runoff enters the trench.
- Offline: Infiltration trenches shall not be utilized as an integral part of the main conveyance system. If the trench runoff is received via a storm drainage system, the trench must generally be located off-line. An off-line trench shall be connected to an inlet structure that has a sump chamber with a minimum depth of 3 feet below the trench inlet pipe. See County Standard SD 70.0 for guidance.

- Public versus Private: The use of an infiltration trench in the public right-of-way is acceptable when primarily treating water from the public right-of-way.

#### 9.7.4.3 Design Calculations

- Downstream storm drain HGL calculations, if applicable.
- Environmental site design volume  $ESD_v$  required in accordance with methodology outlined in Section 9.6.2.
- Environmental site design volume  $ESD_v$  provided.
- Structural Volume required, after accounting for ESD devices proposed
- Structural volume provided, if structural BMPs proposed.
- Drawdown time – Maximum infiltration trench gravel thickness (depth) should be computed to allow complete drainage within 48 hours. For an A soil, the gravel thickness is a maximum of 12 feet and for a B soil; the gravel thickness shall be limited to 5 feet.
- BMP summary table in accordance with Appendix 10-1.
- Hydraulic calculations to demonstrate sizing of outlet structure to convey the 10-year storm to a non-erosive outlet point (e.g., prevent downstream slope erosion). Hydraulic calculations of 100-year storm through the facility, if applicable.
- When calculating volume provided, the trench volume shall be based on a maximum allowable porosity ratio of 0.40.

#### 9.7.4.4 Geotechnical Analysis

Requirements for Geotechnical Field Investigations for infiltration trenches:

- By boring or open excavation
- Soil description to include all soil horizons
- Soil texture to be identified according to the Unified Soil Classification System
- Soil boring depth shall extend a sufficient distance below the bottom of the proposed trench to determine groundwater conditions. The required water table shall be at least 4 feet below the bottom of the trench.



- Groundwater elevation to be recorded at time of boring and after 24 hours. Soil borings must indicate depth to the seasonally high groundwater water table and bedrock, if present.
- See Appendix 9-12 for additional information

#### 9.7.4.5 Specifications and Details

- A. A minimum 4-inch PVC pipe with a screw cap is required for each observation well. The cap shall be set at grade in a mowed area and 6 inches above grade if in a landscape area.
- B. Provide infiltration construction specifications on plan. See Appendix 9-13 for standard notes for construction of an infiltration facility.
- C. Storm drain easements are to be provided in accordance with Chapter 11.
- D. Provide a 6-inch layer of clean, washed sand on the bottom of the trench. (Note: This area may be included in the trench volume computations.) Geotextile fabric may **NOT** be used on the bottom. Manufactured sand is not an acceptable substitute for the sand layer.
- E. All dimensions of the trench shall be shown on the detail sheet. Provide adequate information, including inverts, elevations, and dimensions, as necessary for all pipes and trenches.
- F. Provide approved geotextile fabric on top and sides of trench.
- G. Trenches shall be filled with 1-1/2 to 3-inch washed bank-run gravel or MSHA Size #2 or #3 double-washed gravel. Crushed bluestone is not an acceptable substitute.
- H. Locations of trenches shall be shown on plan view and design plan profile and on the Grading Erosion and Sediment Control Plan.
- I. The invert of the storm drain outfall discharge pipe in the diversion shall be higher than the invert of the infiltration feeder pipe by the required head plus the pipe diameter of feeder pipe required for the peak inflow into the infiltration trench.
- J. Plans should specify the perforation spacing and sizing with the minimum total area greater than 5 times the cross-sectional area of the feeder pipe in the trench.
- K. Whenever feasible, infiltration systems shall include pretreatment techniques to prevent clogging.

- L. Because all infiltration systems must be protected from sediment throughout the development, the infiltration trench feeder pipes shall be blocked until all contributing drainage areas have been completely stabilized. The following note shall be added to the plans: "Infiltration systems shall not receive runoff until the entire contributory drainage area to the infiltration system is permanently stabilized."

## 9.8 Other Structural Devices

Other devices may be primarily used in redevelopment projects and may be supplemented from time to time by MDE. Only devices approved by MDE will be considered by Prince George's County.

### 9.8.1 Hydrodynamic Water Quality Separators

#### 9.8.1.1 Definition and Applicability

Hydrodynamic separators may be used to capture materials such as oil, grit, sediment, trash, and undesirable spills. However, these devices do not contribute to the water quality treatment and therefore may be used as pretreatment practice where heavy automobile traffic and/or parking lots may contribute large loads of oil, grit, and trash to runoff water. They are used to supplement ESD or water quality devices (such as bio retention, bios wale, or other such methods). They do not contribute to meeting any ESD<sub>v</sub> requirements. Hydrodynamic separators may only be utilized on private storm drain systems.

#### 9.8.1.2 Feasibility and Sizing Criteria

The approved sizing criteria by MDE will be used.

#### 9.8.1.3 Design Calculations

- Show the hydraulic gradient through each chamber of the structure based on the 10-year storm if on-line. Assume that the velocity head is 0 (zero) and the gradient will be at the water surface. The hydraulic gradient shall not be higher than the proposed grade. Provide 1 foot of freeboard from the HGL to the top slab.
- Show the downstream storm drain HGL calculations, if applicable.
- Hydrodynamic separators do not contribute to meeting the EDS volume ESD<sub>v</sub>, Water Quality volume WQ<sub>v</sub>, or Channel Protection volume CP<sub>v</sub>. The design consultant shall supplement the hydrodynamic separators with separate BMPs and provide the following computations for the supplemental devices:
  - ESD volume ESD<sub>v</sub> required in accordance with methodology outlined in Section 9.6.2;

- EDS volume  $ESD_v$  provided;
- Water Quality Volume WQV required, if applicable;
- Water Quality Volume WQV provided, if applicable;
- BMP summary table in accordance with Appendix 10-1;
- MDE approval letter with all backup or attachments; and
- Structural computations for cast-in-place structures.

#### 9.8.1.4 Specifications and Details

All of the following notes shall be shown on the plan:

A. General Notes:

1. Refer to manufacturers specifications for material and methods of construction.
2. Wall thickness shall be as follows:
  - a. Minimum of 6 inches thick for the first 8 feet of depth.
  - b. Provide 12-inch-thick walls for structures with depths between 8 and 12 feet.
  - c. Provide 16-inch thick walls for structures with depths greater than 12 feet.
  - d. Variations in thickness can be accepted if structural computations are certified by a professional engineer.
  - e. Depth for structure to be measured from top of top slab to top of bottom slab.
3. All pre-cast structures must have shop drawings approved by DPIE prior to fabrication.
4. When the structure is subject to traffic loading, reinforcing shall be designed for the appropriate traffic loads.
5. Manhole covers shall be provided with adequate locking devices.

B. Construction Notes

1. Silt and debris shall not be allowed to enter the structure until the contributing drainage area has been permanently stabilized.
  2. All openings to the structure shall be protected by the appropriate sediment control measures during construction. See the approved Grading, Erosion and Sediment Control Plan for additional information.
- C. Inspection Notes
- The DPIE inspector shall be contacted at least 48 hours in advance of the beginning of construction of water quality control structures and for final inspection. Contact information for DPIE inspectors can be found at <http://www.princegeorgescountymd.gov/sites/DPIE/ContactUs/PhoneDirectory/Documents/DPIE.InspectionPersonnelDirectory.pdf>
- D. Maintenance Notes
1. The structures will require periodic cleaning. Owners of these facilities will have to clean them as needed or on a frequency that the County determines appropriate, but at a minimum semiannually.
  2. Maintenance of these facilities will consist of cleaning out the separator, disposing of waste, and repairing structures as needed. Periodic inspection of these facilities will be made by DER.

### 9.8.2 Other Proprietary Devices Approved by MDE

Proprietary SWM devices may be considered for use, if the design consultant has demonstrated that ESD has been implemented to the MEP. The use of proprietary devices should be considered after all other means of ESD and filtration and infiltration techniques have been ruled out. The use of any proprietary device can only be approved by the County if MDE has first approved the device for use. These devices, such as Storm Filter, Filterra, and Jellyfish Filter, provide a degree of water quality treatment. However, they are not intended for use to meet CP<sub>v</sub> or larger storm controls (10- and 100-year control). For any proprietary devices proposed to the County for consideration at the time of design, the submittal shall include the MDE approval letter and backup, computations, assumptions, and other information as necessary.

#### 9.8.2.1 Definition and Applicability

Proprietary devices may be used in urban areas with limited space or hotspot areas in lieu of ESD devices. Proprietary devices may only be utilized on private storm drain systems.

### 9.8.2.2 Feasibility and Siting Criteria

The devices must be located in accordance with the manufacturer's criteria; see Sections 9.8 and 9.9 as appropriate.

### 9.8.2.3 Design Calculations

Proprietary devices must be sized to treat the volume of storm water runoff in accordance with MDE manual methods outlined in *Maryland Design Manual* Chapter 3, Section 3.4. The required water quality volume shall be calculated based on standard WQ<sub>V</sub> methodology. The filters shall be sized based on volume and not based on flow rate. The K factor to be used in the following equation shall be based on the MDE-approved K factor for the device. The consultant shall include the letter from MDE that defines the K Factor.+

$$A_f (\text{surface area of filter cartridges}) = WQ_V \times D_f / (K \times (H_f + D_f) \times T_f)$$

Proprietary devices shall be designed to provide 25% of the WQ<sub>V</sub> in pretreatment. The method of providing pretreatment may be configured in a sedimentation chamber, as demonstrated in *Maryland Design Manual* Figures 3.13 and 3.14.

The design consultant shall provide the following design computations for these proprietary devices:

- The hydraulic gradient through each chamber of the structure based on the 10-year storm. Assume that the velocity head is 0 (zero) and the gradient will be at the water surface. The hydraulic gradient shall not be higher than the proposed grade. Provide a minimum of 1 foot of freeboard from the HGL to the bottom of the top slab, grate, or slot opening;
- Downstream storm drain HGL calculations, if applicable;
- Water Quality Volume WQV required;
- Water Quality Volume WQV provided;
- Pretreatment Volume required;
- Pretreatment Volume provided;
- BMP Summary Table in accordance with Appendix 10-1;
- MDE Approval Letter with all attachments and applicable conditions; and

- Structural Computations for cast in place structures.

#### **9.8.2.4 Geotechnical Analysis**

Provide soil borings and report in conformance with the manufacturer's recommendation for geotechnical testing.

#### **9.8.2.5 Specifications and Details**

Provide the manufacturer's specifications and required details for construction of the device.

This Page Intentionally Left Blank

---

## Chapter 10 ENVIRONMENTAL SITE DESIGN (ESD) CRITERIA

### 10.1 Process - Phase Three - Final Plan

The Final Plan is the third and final stage of the three-phase process outlined by the State of Maryland in the 2007 SWM Act and adopted by the County as part of Section 32 Division 3 from Council Bill CB-15-2011. Implementation of the requirements will lead to approval of final design plans and permits for construction of storm drain, SWM, and ESD facilities as well as other site improvements for a project. The final plan is generally submitted and reviewed after approval of the SDCP (issued by DPIE and PGSCD and approval of an SDP if required. See Chapter 6 for further discussion on which projects require a separate SDP (MDE Phase Two).

Submittal of the Final Stormwater Management and Storm Drain Plan includes filing for one of the following permit types:

- Site Development Rough Grading Permit
- Site Development Fine Grading Permit
- Street Construction Permit.

This process is more fully described in Chapter 3.

### 10.2 Definition of ESD Practices

As noted earlier, nonstructural SWM measures, also known as Environmental Site Design (ESD) measures, are all of the storm water measures defined by COMAR 26.17.02.08(B) and described in the *2000 Maryland Stormwater Design Manual, Volumes I and II (MDE, 2000 and 2009) (Maryland Design Manual)* and further defined in County Code Sec. 32-179(a). These planning and treatment practices include:

#### ESD Planning Techniques and Practices

- (A) Preserving and protecting natural resources;
- (B) Conserving natural drainage patterns;
- (C) Minimizing impervious area;
- (D) Reducing runoff volume;
- (E) Using ESD practices to maintain 100 % of the annual average predevelopment groundwater recharge volume;
- (F) Using green roofs, permeable pavement, reinforced turf, and other alternative surfaces;
- (G) Limiting soil disturbance, mass grading, and compaction;



- (H) Clustering development; and
- (I) Any practices approved by MDE.

#### ESD treatment practices

- (A) Disconnection of rooftop runoff;
- (B) Disconnection of non-rooftop runoff;
- (C) Sheet flow to conservation areas;
- (D) Rainwater harvesting;
- (E) Submerged gravel wetlands;
- (F) Landscape infiltration;
- (G) Infiltration berms;
- (H) Dry wells;
- (I) Micro-bio retention;
- (J) Rain gardens;
- (K) Swales;
- (L) Enhanced filters; and
- (M) Any practice approved by the MDE.

These measures shall be implemented to the maximum extent practicable.

### **10.3 Public/Private Definition and Maintenance**

Section 5.2.5 of this manual defines standards for public versus private storm drain and SWM systems.

### **10.4 Approval Authority, Process and Permitting**

#### **10.4.1 Approval Authority**

All SWM facilities permitted by the County are reviewed and approved by DPIE prior to permit issuance. For ESD, approval is only required from DPIE for SWM. Other agency approvals are required for different aspects of the project.

#### **10.4.2 DPIE**

All SWM facilities in Prince Georges County require approval from DPIE, except for projects in the City of Bowie or State and Federal projects. Consult Section 9.5 for further guidance.

### 10.4.3 PGSCD

PGSCD does not review SWM plans; however, it reviews the design consultant's determination to confirm whether the devices are exempt from small pond approval and/or are deemed as small ponds and need to meet MD-378 criteria. In addition, the agency reviews related plans for erosion and sediment control.

### 10.4.4 Municipalities

All projects within the City of Bowie require the City's approval for SWM facilities. These projects do not require DPIE approval. All other municipalities require DPIE review and approval for SWM and ESD facilities.

### 10.4.5 M-NCPPC

All SWM facilities that extend onto M-NCPPC-owned land require review and approval by the M-NCPPC DPR to ensure compatibility with their requirements. M-NCPPC also reviews related plans including Preliminary Plan of Subdivision, Detailed Site Plans, Special Exception, Special Permit, Chesapeake Bay Critical Area (CBCA) Plans, and Specific Design Plans as they relate to the SDCP and technical SWM approvals and impacts to M-NCPPC land.

### 10.4.6 Federal and State Projects

All projects proposed on Federal or State-owned land where the applicant is also a State or Federal agency will require MDE approval for SWM facilities. The County may make recommendations to MDE to require 10-year and/or 100-year flood control. The County will provide review comments for projects subject to the County's Clearinghouse Review Process. Comments may include recommendations for off-site improvements where project impacts may have an adverse impact. When the applicant (entity signing the owner/developer's certification) is a private company or local government, projects on Federal or State land will be reviewed by the County.

## 10.5 BMPs - General Design Criteria

ESD devices may be designed by a Professional Engineer or Registered Land Surveyor provided the latter does not require any embankment determination using MD-378 or structural facilities such as a green roof or cistern and the distribution system. Otherwise, only a Professional Engineer may sign and seal the drawings.

### 10.5.1 Computations

The following H&H computations shall be provided for all BMPs and reported on a BMP summary table per the format in Appendix 10-1.

- RCNs for each BMP
- Total Drainage Area for each BMP

- Impervious Drainage Area for each BMP
- Pre- and Post-Development RCN, DA, TC and flows for the 10- and 100-year storms, if overbank flood protection (10-year) or extreme flood protection (100-year) attenuation is required. These values shall be provided at various study points where drainage exits the site.
- Downstream storm drain HGL calculations, if applicable
- Environmental site design volume  $ESD_v$  required
- Environmental site design volume  $ESD_v$  provided
- Environmental site design volume  $ESD_v$  maximum
- Drawdown time – Provide computations as required for certain practices per *Maryland Design Manual* to demonstrate that drain down occurs within 48 hours.
- Spillway Sizing - Provide hydraulic calculations to size spillway structures to convey the 10-year storm to a non-erosive outlet point. Smaller practices that are exempt from small pond standards shall be sized to convey the 10-year storm through an overflow pipe or a grass spillway that may be located at the top of the embankment. This generally applies to submerged gravel wetlands, micro-bio retention, rain gardens, and infiltration berms, etc. If the facility is not exempt from small pond standards, then all MD-378 requirements, including sizing of spillways for the 100-year design storm, shall be provided.
- The maximum drainage area shall be per MDE Chapter 5.

### 10.5.2 $ESD_v$ , $WQ_v$ , $CP_v$ sizing

The design review checklists on the DPIE website incorporate MDE design criteria as well as County-specific criteria to be included on the design plan. The design consultant shall utilize the latest design-specific computations from Appendix 10-2 or follow the procedures for calculations provided in the MDE ESD publication:

#### [Environmental Site Design Process & Computation](#)

Calculating ESD Target (Required) Volume: Final plans shall provide sizing calculations in accordance with the *Maryland Stormwater Design Manual*. The ESD target (required) volume shall be 100% of the total calculation – **Prince Georges County does not allow for 25% reduction**. Calculations shall include the ESD target volume (“required volume”) to each point of interest. A sub-drainage area, measured to the location where

drainage leaves the site is considered a point of interest. The site's natural and manmade drainage divides will be used to demarcate the various sub-watersheds.

ESD target volume is to be calculated as:

$$ESD_V = P_E \times R_V \times A/12 \quad (\text{Maryland Design Manual Chapter 5})$$

A (Area) shall be the entire disturbed area of the site.

Calculating ESD<sub>V</sub> Provided: The method of calculating ESD<sub>V</sub> provided varies depending on the type of BMP. When the cumulative volume for all ESD practices meets or exceeds 100% of the target ESD<sub>V</sub>, then SWM requirements are met and no WQ<sub>V</sub> or CP<sub>V</sub> is required, except for projects that require 10 year Q<sub>p</sub> or 100 year Q<sub>f</sub> controls

Calculating ESD<sub>V</sub> Maximum: The method of calculating ESD maximum volume shall be calculated using 2.7 inches for P<sub>E</sub>, using actual impervious area to the BMP. A BMP shall not receive any credit if the volume is greater than the ESD maximum volume.

Full Compliance with ESD: If ESD is fully implemented based on the guidelines in MDE *Maryland Stormwater Design Manual* Chapter 5, and if there are no downstream issues to address (10- or 100-year flood control), then structural practices are not required. If the design rainfall captured and treated by ESD measures is short of the target rainfall and volume, then structural BMPs shall provide any remaining SWM volume to achieve woods in good condition. The method of sizing supplemental structural BMPs is shown in Section 9.6.2.

Cumulative ESD<sub>V</sub> and Points of Investigation: Calculations shall include the ESD target volume ("required volume") to each point of interest. A point of interest is considered a sub-drainage area on the site. The site's natural and manmade drainage divides will be used to demarcate the various sub-watersheds. Calculations shall also define ESD<sub>V</sub> provided to each point of interest, as follows:

- Calculate ESD<sub>V</sub> provided at each BMP.
- Each individual ESD device can provide less than the ESD target volume, but must be at least a P<sub>E</sub> of 1.0 inch.
- Each individual ESD device can provide more than the ESD target volume, but not more than the ESD maximum volume, calculated with P<sub>E</sub> = 2.7".
- Confirm that provided volumes do not exceed ESD maximum – reduce the size of each BMP if necessary.
- Subtotal target and provided ESD<sub>V</sub>s at each point of interest.

- Cumulative volumes are to be achieved at each point of interest. Excess volume provided cannot be transferred from one point of interest to another.

Multiple ESD Practices and Under sizing/Oversizing: Where multiple ESD practices are used within a drainage area, downstream individual practices may be oversized on a limited scale to compensate or over manage for upstream smaller practices. For this approach to be incorporated into the design, the upstream devices cannot use an overflow storm drain system to collect flow. The size of any practice(s) is limited to the runoff from the maximum volume allowed, based on a 1-year, 24-hour storm (2.7 inches) draining to the device.

Maximum Drainage Area: ESD devices can treat areas greater than the allowable drainage area established for each device in the *Maryland Design Manual*, **only** if the additional area is for the installation of the device itself, such as area of device, BMP side slopes, and BMP access roads.

### 10.5.3 Overbank Flood Protection $Q_P$ (10-Year) Sizing

Overbank flood protection generally cannot be achieved with nonstructural practices. If this level of SWM is required, structural BMPs are required, although an RCN may be calculated to reduce the amount of storage required. See Section 9.6.3 for more information.

### 10.5.4 Extreme Flood Protection $Q_F$ (100-Year) Sizing

Extreme flood protection generally cannot be achieved with nonstructural practices except for permeable paving and green roofs, as they are valid for all storm events. If this level of SWM is required, structural BMPs are required. See Section 9.6.4 for more information.

### 10.5.5 Geotechnical Analysis

Geotechnical testing and analysis are required at or within 30 feet of the location of the device for any device as defined below:

- GWT: If sufficient evidence is provided at the SDCP stage, this criterion may be waived for groundwater testing in parts or the entire site. Geotechnical analysis shall define the seasonal high groundwater elevations for the following BMP types if "YES" is noted. The bottom of some devices should be designed at least 4 feet above the seasonal groundwater level unless the facility is lined and an underdrain is provided.

- U.S. Department of Agriculture (USDA) Hydrologic Soil Type: The Final Plan shall define the hydrologic soil group (A, B, C, or D) for the BMP types listed below.
- Infiltration Testing: Many nonstructural devices require underdrains as defined in Table 10-1. If the design consultant is proposing to **NOT** provide underdrain, for a device that normally requires an underdrain, the request will be approved if an infiltration test indicates a rate of 0.52 inch per hour and an outfall for the underdrain is not feasible.  
**Infiltration testing is required for permeable pavement applications that are larger than 10,000 sf.** See Appendix 9-12 for testing requirements.

**Table 10-1 ESD Device Geotechnical Determination**

Non Structural BMP Type	GWT testing	Hydrologic Soil Group	Infiltration Testing
Green Roof	NO	NO	NO
Permeable Pavement	YES (stone must be 4 feet above GWT)	YES allowed in A, B, and C soils only	YES if larger than 10,000- square-foot area
Reinforced Turf	NO	NO	NO
Disconnection of Rooftop Runoff	NO	NO	NO
Disconnection of Non Rooftop Runoff	NO	NO	NO
Sheet Flow to Conservation Areas	NO	NO	NO
Rainwater Harvesting	NO	NO	NO
Submerged Gravel Wetland	YES to calculate storage in gravel and determine dewatering during construction	YES allowed in C/D soils only	NO
Landscape Infiltration	YES (must be 4 feet above GWT)	YES depth varies if A/B, not allowed in C/D	YES if DA impervious percentage exceeds 50%.
Infiltration Berms	NO	NO	NO
Dry Wells	YES (must be 4 feet above GWT)	YES max depth varies A/B, not allowed C/D	NO
Micro Bio retention	YES (must be 4 feet above GWT)	YES for info - underdrain decisions	YES if eliminating underdrain

Non Structural BMP Type	GWT testing	Hydrologic Soil Group	Infiltration Testing
Rain Gardens	YES (must be 2 feet above GWT)	YES - soil amendment if C/D	YES if eliminating underdrain
Swales	YES (wet swales must sit in GWT, dry swales require 4 feet, and bios wales must be 2 feet above)	YES - dry or bios wales in A,B, C, wet swales in C/D	YES if eliminating underdrain in bios wale
Enhanced Filters	Yes (must be 4 feet above GWT)	NO	YES

**10.5.6 BMP - Summary Table**

A BMP summary table shall be provided on all SWM plans, in conformance with the format included in Appendix 10-1.

In tabular form, the Final Plan shall provide sizing calculations for ESD devices. The information to be included in the BMP Summary Table includes, at a minimum:

- Define target  $ESD_v$  to each BMP.
- Define provided  $ESD_v$  to each BMP.
- Subtotal target and provided  $ESD_v$  at each point of interest.
- Each individual ESD device can provide more than the ESD target volume, but not more than the ESD maximum volume, calculated with  $P = 2.7"$ .
- Define ESD maximum volume for each BMP.
- Define drainage area.
- Define drainage area for each BMP.
- Define impervious area for each BMP.
- Define Percent Impervious,  $R_v$  and Target  $P_E$  for each BMP.
- Adjust BMP sizes to ensure that  $ESD_v$  provided meets or exceeds 100% of the target  $ESD_v$ .

- Cumulative volumes are to be achieved at each Point of Interest. Excess volume provided cannot be transferred from one point of interest to another.

ESD techniques and treatment practices must be exhausted before any structural BMP approaches will be allowed.

### 10.5.7 Easements

Easements or dedications are required for public facilities. A Declaration of Covenant (commonly referred to as maintenance agreement) is required for private facilities.

The following requirements pertain to nonstructural BMPs:

- A Declaration of Covenant is required for Disconnection of Rooftop (N-1) and Disconnection of Non-Rooftop (N-2) in some cases. The entire disconnection flow path must be located on the subject property or incorporated into offsite easements that protect the integrity of the sheet flow. The area to be protected shall be clearly labeled on the plan.
- Easements are required for Sheet Flow to Conservation Areas (N-3). Sheet flow to a conservation area may **NOT** be located on residential lots unless otherwise approved by the Director. Public maintenance access and formal, legal protection are essential for long-term viability of conservation areas.
- Green Roof: A Declaration of Covenant is required.
- Permeable Paving and Reinforced Turf: Unless the permeable paving is located in the public right-of-way, a Declaration of Covenant is required.
- Rain Barrels/Cistern: A Declaration of Covenant is required.
- Submerged Gravel Wetlands: For public facilities, provide an easement for the access road and facility. Private facilities will require a Declaration of Covenant.
- Landscape Infiltration: For public facilities, provide an easement for access road and facility. Private facilities will require a Declaration of Covenant.
- Infiltration Berms: A Declaration of Covenant is required.
- Dry Wells: A Declaration of Covenant is required.
- Micro-Bio retention: For public facilities, provide an easement for the access road and facility. Private facilities will require a Declaration of Covenant.
- Rain Gardens: For public facilities, provide an easement for access road and facility. Private facilities will require a Declaration of Covenant.



- Swales: Unless located in the public right-of-way, provide easement and for private facilities, a Declaration of Covenant is required.

## 10.6 Nonstructural BMPs - Alternative Surfaces (A-1, A-2, A-3)

ESD site design that uses more permeable alternatives is an effective method to reduce imperviousness and meet ESD treatment goals. These ESD approaches can be implemented in any private development, including residential, commercial, and industrial applications as well as parking lots and drive aisles. Roofs and pavements are often overlooked areas that may be replaced with more permeable surfaces. Green roofs are particularly useful alternatives for reducing impervious cover and provide much needed green space in ultra-urban or high-density developments. Whether made from porous asphalt or concrete, interlocking pavers, or reinforced turf, permeable pavements may be a cost-effective alternative to provide ESD for parking lot and private roadway surfaces.

- Green Roofs A-1
- Permeable Pavements A-2
- Reinforced Turf A-3

### 10.6.1 Green Roof

The following is an excerpt from Chapter 5 of the *Maryland Design Manual*.

Green roofs are alternative surfaces that replace conventional construction materials and include a protective covering of planting media and vegetation. Also known as vegetated roofs, roof gardens, or eco-roofs, these may be used in place of traditional flat or pitched roofs to reduce impervious cover and more closely mimic natural hydrology. Green roofs produce less heat than conventional systems. Therefore, they may be used to help mitigate storm water impacts and temperature increases caused by new development.

There are two basic green roof designs that are distinguished by media thickness and the plant varieties that are used. The more common or 'extensive' green roof is a lightweight system where the media layer is between 2 and 6 inches thick. This limits plants to low-growing hardy herbaceous varieties. An extensive green roof may be constructed off-site as a modular system with drainage layers, growing media, and plants installed in interlocking grids.

Conventional construction methods may also be used to install each component separately. 'Intensive' green roofs have thicker soil layers (8 inches or greater) and are capable of supporting more diverse plant communities including trees and shrubs. A more robust structural loading capacity is needed to support the additional weight of the media and plants. Intensive green roofs are more complex and expensive to design, construct, and maintain, are less commonly used, and are therefore not covered here.

### 10.6.1.1 Feasibility and Siting Criteria

Green roofs may be used to replace most conventional roofs, in both new and redevelopment applications, and in multi-family or high-rise residential, commercial, and industrial projects. Green roofs are not suitable on steep roofs (greater than 30%). A green roof may also mitigate water temperature increases, and should be considered for projects located in thermally sensitive watersheds. In Prince George's County, this would apply to the Northwest Branch and all tributaries above East-West Highway (Route 410) as well as Paint Branch and all tributaries upstream of I-495. For additional information on the design of green roofs, see Chesapeake Stormwater Network Stormwater Design Specification No. 5 and the *Maryland Design Manual*.

Extent of Green Roof: The available roof area is typically reduced by walkways, heating, ventilation, and air conditioning equipment, stairwells, and elevator shafts. A vegetation-free zone of approximately 2 feet shall be provided around the perimeter of the roof and 12 inches from any roof penetrations. The vegetation-free zone does not apply to walkways. Include in the design plan a roof layout to show all roof features and vegetated areas.

Pretreatment: Recharge volume (Rev) shall be provided in a separate infiltration practice or in a downstream ESD device. Green Roofs do not provide groundwater recharge.

### 10.6.1.2 Design Calculations

In addition to the calculations defined in Section 10.6, the design consultant shall provide ESD<sub>v</sub> calculations in accordance with the following guidance.

ESD<sub>v</sub> provided by green roofs shall be calculated from Table 10-2, which was obtained from Table 1 in the MDE publication *Environmental Site Designs and Process, July 2010*. The table incorporates ESD<sub>v</sub> psf of green roof, which may be used in the design computations.

**Table 10-2 ESD<sub>v</sub> Provided by Green Roof**

Green Roof Thickness	RCN	ESD <sub>v</sub> provided psf of roof (ESD <sub>v</sub> /ft <sup>2</sup> )	Equiv. PE (in.)
2"	94	0.035	0.4
3"	92	0.05	0.6
4"	88	0.077	1
6"	85	0.095	1.2
8"	77	0.134	1.7

Structural Computations: It is the responsibility of the design consultant to provide structural engineering analysis to address all structural issues for roof support.

#### **10.6.1.3 Plan Preparation Specifications and Details – Green Roofs (A-1)**

Roof designs such as structural, waterproof membrane, drainage system, and drainage layer shall be in accordance with ASTM (2005) International Green (Vegetated) Roof Standards or later version.

A typical cross section of the roof with dimensions of materials shall be included with the design plans.

#### **10.6.1.4 Landscape Criteria**

Plant material shall be selected based on hardiness zones from the *2011 Maryland Standards and Specifications for Soil Erosion and Sediment Control Manual*. In general, the dividing line runs east-west along Central Avenue with hardiness zone 6B to the north and 7A to the south. Also, see ASTM E-2400-06, *Guide for Selection, Installation, and Maintenance of Plants for Green (Vegetated) Roof Systems*.

### **10.6.2 Permeable Pavement (A-2)**

Permeable pavements are alternative surfaces that may be used to reduce imperviousness. While there are many different materials commercially available, permeable pavements may be divided into three basic types: porous bituminous asphalt, pervious concrete, and permeable interlocking concrete pavements. Permeable pavements typically consist of a porous surface course and open graded stone base/sub base or sand drainage system. Stormwater drains through the surface course, is captured in the drainage system, and infiltrates into the surrounding soils. Permeable pavements significantly reduce the amount of impervious cover, as they can be considered hydrologically pervious, provide water quality and groundwater recharge benefits, and may help mitigate water temperature increases in the receiving streams.

#### **10.6.2.1 Feasibility and Siting Criteria**

Permeable pavements are effective for reducing imperviousness in pedestrian pavements, parking lots, driveways, sidewalks and pathways, plazas, and access roads. They may be used in both new and redevelopment applications in residential, commercial, and industrial projects. At this time, DPIE will **NOT** accept any type of permeable pavements within the public right-of-way or public easement. Permeable pavements are particularly useful in high-density areas where space is limited for installation of nonstructural devices. Like all ESD devices, longevity of operation and maintenance of the permeable pavement is a concern. Therefore, the design consultant must evaluate whether the application is appropriate based on the use.

Additional information on permeable pavements may be found in Chesapeake Stormwater Network Design Specification No. 7. Specifications for porous asphalt and concrete are located in the *Maryland Design Manual* Appendix B.4. The specification for construction installation must be included on the design plan.

Permeable pavements should be used only where regular maintenance can be performed.

The following shall be used for siting permeable paving.

Soils: Permeable pavement is permissible in A, B, and C soils. It is not allowed in D soils.

Infiltration Rate: Permeable pavement areas larger than 10,000 sf are not permissible unless infiltration rates are 0.52 inch per hour or greater.

GWT: Permeable pavement gravel bedding shall be sited at least 4 feet above the groundwater table.

Distance to Utilities: Locate to maintain a minimum of 1-foot horizontal clearance from underground utilities such as buried electric lines, gas lines 3 inches or smaller, and buried communication lines. No clearance is required for these utilities if they are in a conduit.

Distance to Buildings: Locate at least 10 feet from buildings and down gradient of buildings.

Distance to Well/Septic: Locate at least 100 feet from unconfined water supply wells and 25 feet from septic systems.

Private: Permeable pavement is permitted only in private SWM systems.

Landscaping: Trees generally should be located at least 5 feet away and shrubs at least 2 feet away from the permeable paving where damage by root penetration is a concern.

#### **10.6.2.2 Geotechnical Analysis**

Soil borings to establish the groundwater elevation and infiltration rates shall be provided at a minimum of 1 boring per 2,500 sf of permeable paving area.

#### **10.6.2.3 Design Calculations**

In addition to the calculations defined in Section 10.6, the design consultant shall provide  $ESD_v$  calculations in accordance with the following guidance.

$ESD_v$  provided by Permeable Pavement shall be calculated from Table 10-3, which was obtained from Table 1 in the MDE publication *Environmental Site Designs and Process, July 2010*. It incorporates an  $ESD_v$  psf of permeable

pavement.

#### 10.6.2.4 Plan Preparation, Specifications, and Details

Additional gravel bed thickness may be used in fill areas. Fill materials meeting County DPW&T standard A-2 or A-3 may be acceptable in lieu of gravel media to intercept existing soil. A typical section and specification may be found in Appendix 10-4.

**Table 10-3 ESD<sub>v</sub> Provided by Permeable Pavement Storage Media**

Permeable Pavement									
	HSG A			HSG B			HSG C		
Sub base	RCN	ESD <sub>v</sub> / ft <sup>2</sup>	Equiv. P <sub>E</sub> (in.)	RCN	ESD <sub>v</sub> / ft <sup>2</sup>	Equiv. P <sub>E</sub> (in.)	RCN	ESD <sub>v</sub> / ft <sup>2</sup>	Equiv. P <sub>E</sub> (in.)
6"	76	0.138	1.7	84	0.101	1.3	93	0.043	0.5
9"	62	0.183	2.3	65	0.175	2.2	77	0.134	1.7
12"	40	0.206	2.6	55	0.196	2.5	70	0.16	2

#### 10.6.3 Reinforced Turf (A-3)

Reinforced turf consists of interlocking structural units with interstitial areas for placing gravel or growing grass. These systems are suitable for light traffic loads and are commonly used for emergency vehicle access roads and overflow or occasionally for parking. They are **NOT** acceptable for use in the public right-of-way.

##### 10.6.3.1 Feasibility and Siting Criteria

Reinforced turf is effective for reducing imperviousness in parking lots, driveways, plazas, and access roads in both new and redevelopment applications in residential, commercial, and industrial projects. It is particularly useful in high-density areas where space is limited. Because reinforced turf is an open load-bearing matrix within a vegetated or gravel surface, runoff characteristics are similar to open space in good condition.

Reinforced turf should be used only where regular maintenance can be performed.

Reinforced turf should be located to maintain a minimum of 2 feet horizontal clearance from subgrade from underground utilities such as buried electric lines, gas lines that are 3 inches or smaller, and buried communication lines. No vertical clearance is required for any crossing by a conduit.

##### 10.6.3.2 Design Calculations

The ESD<sub>v</sub> target shall be calculated based on the reduced imperviousness resulting from this type of surface. For the portion of the site proposed as reinforced turf, the area shall be considered open space in good condition grass (based on USDA TR55 table 2-2.a), an RCN of 39, 61, or 74 for A, B, or C soils respectively).

**10.6.3.3 Plan Preparation, Specifications, and Details**

Additional gravel bed thickness may be used in fill areas. Fill materials meeting DPW&T standard A-1, A-2, or A-3 may be acceptable in lieu of gravel media to intercept existing soil.

**10.6.3.4 Landscape Criteria**

Reinforced turf must also be identified on landscape plans. Trees generally should be located at least 5 feet away and shrubs at least 2 feet away from the reinforced turf where damage by root penetration is a concern.

**10.7 Nonstructural BMPs – Nonstructural Practices (N-1, N-2, N-3)**

Disconnecting impervious cover and treating urban runoff closer to its source are the next steps in the design process for implementing ESD. Using nonstructural techniques (e.g., disconnection of rooftop or non-rooftop runoff, sheet flow to conservation areas) and micro-scale practices (e.g., rain gardens, bio-swales) throughout a development are effective ways to accomplish this goal. Nonstructural practices may be used to disconnect impervious cover and direct runoff over vegetated areas to promote overland filtering and infiltration. Micro-scale practices are useful for capturing and treating runoff near the source. Whether runoff is directed over permeable areas or captured in small water quality treatment practices, there are reductions in both volume and pollutants delivered to receiving streams. Accordingly, these practices may be used to address the ESD sizing criteria when designed and implemented properly.

Nonstructural/micro-scale practices are an integral part of the ESD SWM plans. Therefore, the use of these practices shall be documented during the planning and design stages and verified with an as-built certification.

Nonstructural practices combine relatively simple features, grading, and landscaping, to divert runoff into vegetated areas before discharging to a protected green area or eventual into conventional storm drain systems. Runoff flows over these areas, filters through the vegetation, and soaks into the ground. Runoff should be conveyed as sheet flow into and through these areas. As depth and velocity of flow increase, runoff becomes concentrated, and the capacity of vegetation to filter and detain runoff diminishes rapidly. Consequently, requirements and conditions for nonstructural practices reflect the need to maintain sheet flow conditions.

- A. Disconnection of Rooftop Runoff N-1
- B. Disconnection of Non-Rooftop Runoff N-2

Utility crossings of any disconnection areas are acceptable, subject to M-NCPPC approval for location if the sheet flow area is located in Forest Conservation easements.

### 10.7.1 Disconnection of Rooftop Runoff (N-1)

Rooftop disconnection involves directing flow from downspouts onto vegetated areas where it can soak into or filter over the ground. This disconnects the rooftop from the storm drain system and reduces both runoff volume and pollutants delivered to receiving waters. To function well, rooftop disconnection is dependent on several site conditions such as permeable flow path length, soils, slopes, compaction, etc. This technique is a cost-effective and natural method of achieving the goals of ESD.

#### 10.7.1.1 Feasibility and Siting Criteria

There are many opportunities for disconnecting rooftops in both new and redevelopment designs. Runoff may be directed to undisturbed natural areas (e.g., vegetated buffers) or landscaped areas (e.g., lawns, grass channels). Rooftop disconnection is possible in commercial, industrial, and residential settings given the design guidance listed below.

- Disconnection Flow Path Lengths: Disconnection flow path lengths may range from 15 to 75 feet and result in varying degrees of ESD<sub>v</sub> control.
- Disconnection Flow Path Slopes: These shall not exceed 5%, unless terraced, per *Maryland Design Manual*.
- Drainage Area: Maximum drainage area from each downspout is 500 sf.
- Swales: Swales may not be used to modify disconnection flow paths, as they discourage sheet flow. If a swale is used, the bottom must be at least 10 feet wide and the underlying soil must be mixed with compost.
- Onsite or Easements: The entire disconnection flow path must be located on the subject property or incorporated into offsite easements that protect the integrity of the sheet flow.
- Downspout Location: Disconnected downspouts shall be at least 10 feet from the nearest impervious surface, property line, or lower elevation to prevent reconnection.

#### 10.7.1.2 Design Calculations

In addition to the calculations defined in Section 10.6, the design consultant shall provide ESD<sub>v</sub> calculations in accordance with the following guidance.

ESD<sub>V</sub> provided by Disconnection of Rooftop Runoff shall be calculated as per *Maryland Design Manual* Table 5.6:

$$\text{ESD}_V (\text{Provided}) = P_E \times R_V \times A / (12)$$

$P_E = 0.2$  inch if length of disconnect is 15 feet

$P_E = 0.4$  inch if length of disconnect is 30 feet

$P_E = 0.6$  inch if length of disconnect is 45 feet

$P_E = 0.8$  inch if length of disconnect is 60 feet

$P_E = 1.0$  inch if length of disconnect is 75 feet

$R_V = 0.95$  (for impervious roof)

A = Area of roof (maximum allowed 500 sf)

### 10.7.1.3 Plan Preparation, Specifications, and Details

The area of disconnection shall be clearly identified and labeled as “**REQUIRED DISCONNECT OF ROOFTOP RUNOFF PATHWAY**” on any plan approved by DPIE, as well as entitlement Site Plans approved by M-NCPPC. If any revision to the Site Plan and downspouts is proposed, this revision shall not disrupt or alter the disconnection path without a revision to the DPIE SWM plan, grading permit, and building permit. The review by DPIE as part of the building permit review process will confirm that the maximum drainage area from any roof drain is less than 500 sf.

All downspouts shall outfall to splash blocks.

If there has been extensive construction traffic over the disconnection area, tilling with the addition of soil amendments or equivalent shall be considered.

### 10.7.1.4 Landscape Criteria

Disconnection of rooftop runoff is most commonly proposed for lawn areas with turf grass. However, other types of vegetation such as trees, shrubs, or other herbaceous plants are acceptable, provided the flow area is well vegetated with healthy plants.

## 10.7.2 Disconnection of Non-Rooftop Runoff (N-2)

Non-rooftop disconnection involves directing flow from impervious surfaces onto vegetated areas where it can soak into or filter over the ground. This disconnects these surfaces from the storm drain system, reducing both runoff volume and pollutants delivered to receiving waters. Non-rooftop disconnection is commonly applied to smaller or narrower impervious areas like driveways, open section roads, and small parking lots. It is dependent on several site conditions (e.g., permeable flow path length, soils, slopes, compaction) to function well. This technique is a cost effective and natural method of achieving the goals of ESD.



### 10.7.2.1 Feasibility and Siting Criteria

There are many opportunities for disconnecting impervious surfaces in both new and redevelopment designs. Runoff may be directed as sheet flow to undisturbed natural areas (e.g., vegetated buffers) or landscaped areas (e.g., lawns, wide grass channels or swales). Non-rooftop disconnection is possible in commercial, industrial, and residential settings given the constraints listed below.

- Continuously Pervious Disconnect Path: Disconnections may not flow across impervious areas or connect with flow from other sources for their entire treatment length.
- No Concentrated Flows: The credited flow length must remain separate from other areas of concentrated flow for its entire credited flow length.
- Disconnection Flow Path Lengths: Disconnection flow path lengths may range from 10 to 75 feet and result in varying degrees of ESD control.
- Disconnection Flow Path Slopes: These shall not exceed 5% unless terraced, per *Maryland Design Manual*.
- Pervious ratio reduction in *Maryland Design Manual* Table 5.7 is generally not acceptable for use in Prince George's County.
- Drainage Area: Maximum drainage area to each downspout is 1,000 sf.
- No Swales: Swales may not be used to modify disconnection flow paths, as they discourage sheet flow.
- Onsite: The entire disconnection flow path must be located on the subject property or in an easement that protects the integrity of the flow. Disconnection credit will not be given for flow beyond the property line.

### 10.7.2.2 Design Calculations

In addition to the calculations defined in Section 10.6, the design consultant shall provide ESD<sub>v</sub> calculations in accordance with the following guidance.

A combination of impervious and pervious flow path may be used per the following formula, with the contributing flow path (across pavement) L paved limited to a maximum of 75 feet.

$L_{\text{pave}} = \text{Impervious material length} + 0.5 * \text{pervious material length}.$

ESD<sub>v</sub> provided by Disconnection of Rooftop Runoff shall be calculated as per MDE Table 5.7:

$$ESD_V \text{ (Provided)} = P_E \times R_V \times A / (12)$$

$R_V = 0.95$  (for impervious pavement)

A = area of non-roof (maximum allowed 1,000 square feet)

For paved area sheet flowing to landscaped area

Contributing length (L pave) = Length of drainage path across paved area

Disconnection length (L sheet) = Length that runoff from paved area sheet flows across landscaped area

Based on *Maryland Design Manual* Table 5.7

$P_E = 0.2$  inch if L sheet/L pave = 0.2

$P_E = 0.4$  inch if L sheet/L pave = 0.4

$P_E = 0.6$  inch if L sheet/L pave = 0.6

$P_E = 0.8$  inch if L sheet/L pave = 0.8

$P_E = 1.0$  inch if L sheet/L pave = 1.0

### 10.7.2.3 Plan Preparation, Specifications, and Details

Transition Strip: A 1- to 2-foot-wide pea gravel transition strip between the impervious area and the pervious treatment area shall be provided to ensure runoff will flow in a safe and non-erosive manner. The gravel shall meet ASTM C-43 Size #57.

Label Disconnection Area on Plan: The area of disconnection shall be clearly labeled on the SWM and Site Plan as “**REQUIRED DISCONNECT OF NON-ROOFTOP RUNOFF PATHWAY**” on any plan approved by DPIE, as well as site plans approved by M-NCPPC and DPIE. If any revision to the site design is proposed, this revision shall not disrupt or alter the disconnection path without formal revision to the DPIE SWM plan and permit, or the building permit grading plan shall address any revision to the approved plan by a relocation or substitution for the treatment volume that is reduced.

Label Tilling Requirement on Plan: If there has been extensive construction traffic over the disconnection area, tilling with soil amendments or its equivalent shall be considered.

### 10.7.2.4 Landscape Criteria - Disconnection of Non-Rooftop Runoff (N-2)

Disconnection of Non-Rooftop Runoff is generally proposed for lawn areas with turf grass. However, other types of vegetation such as trees, shrubs, or other herbaceous plants are acceptable provided the flow area is well vegetated with healthy plants.

### 10.7.3 Sheet Flow to Conservation Areas (N-3)

Stormwater runoff is effectively treated when flow from developed land is directed to adjacent natural areas where it can soak into or filter over the ground. To function well, this practice is dependent on several site conditions such as buffer size, contributing flow path length, slopes, and compaction. This technique is a cost-effective and natural method for achieving the goals of ESD.

#### 10.7.3.1 Feasibility and Siting Criteria

Sheet flow to conservation areas may be used in most development situations provided that site conditions allow implementation. This practice may be used wherever existing stream buffers and other natural areas are protected, expanded, or created during project planning, and storm water runoff may be directed into them, given the design guidance below.

Maximum Contributing Length: The maximum upstream length draining to the conservation area shall be 75 feet for impervious areas.

Slopes: The contributing (upstream) slope shall be 5% or less. The maximum average slope in the conservation area shall be 5% for the length of treatment, with a maximum slope of 8% for short reaches. The total length of the conservation area shall not exceed 100 feet.

Required Conservation Area: The conservation area shall be 20,000 sf or larger.

Conservation Area Flow Path Lengths: Flow path lengths may range from 50 to 100 feet (or more) and variable lengths result in varying degrees of ESD<sub>v</sub> provided.

Easements: Public maintenance access and formal, legal protection are essential for long-term viability of conservation areas. The M-NCPPC Conservation Easement or a similar document will satisfy the requirement. All other easements must clearly specify how the natural area vegetation shall be managed and boundaries will be marked.

#### 10.7.3.2 Design Calculations

In addition to the calculations defined in Section 10.6, the design consultant shall provide ESD<sub>v</sub> calculations in accordance with the following guidance.

ESD<sub>v</sub> provided by Sheet Flow to Conservation Area shall be calculated as per

*Maryland Design Manual* Table 5.8, which is summarized below.

$$\text{ESD}_V \text{ (Provided)} = P_E \times R_V \times A / (12)$$

Sheet Flow to Conservation Area length (L sheet) = Length that runoff from paved area sheet flows across conservation area.

Based on MDE Table 5.8

$P_E = 0.6$  inch if L sheet = 50 feet

$P_E = 0.8$  inch if L sheet = 75 feet

$P_E = 1.0$  inch if L sheet = 100 feet

$R_V = 0.95$  (for impervious pavement)

A = contributing impervious area

### 10.7.3.3 Plan Preparation, Specifications, and Details

Stormwater shall not be directed to conservation area until level spreader, gravel diaphragm, etc., are installed.

Gravel Transition Strip: A 1- to 2-foot-wide pea gravel transition strip between the impervious area and the pervious treatment area shall be provided to ensure runoff will flow in a safe and non-erosive manner. The gravel shall meet ASTM C-33 Size #57.

Label Sheet Flow Conservation Area on Plan: The sheet flow conservation area shall be clearly labeled on the SWM and site plan as **“REQUIRED CONSERVATION AREA FOR SHEET FLOW ESD RUNOFF PATHWAY”** on any plan approved by DPIE, as well as site plans approved by M-NCPPC. If any revisions to these plans are proposed, the revision shall not disrupt or alter the sheet flow conservation path without formal revision to the DPIE SD/SWM plan and permit.

## 10.8 Micro-scale Practices (M-1 through M-9)

Micro-scale practices are small water quality treatment devices used to capture and treat storm water runoff from discrete impervious areas (e.g., less than 1 acre). These practices typically include natural systems, vegetation, and soils, and they may be interconnected to create a more natural drainage system. In many cases, they may resemble the larger structural practices such as infiltration, bio retention, and filters described in Chapter 9. The design variants listed below shall be distributed throughout a project site to provide SWM at the source, unlike their structural relatives that were more typically used as “end-of-pipe” treatment for larger drainage areas. Micro-scale practice variants with the MDE designation include:

- Rainwater Harvesting M-1

- 
- Submerged Gravel Wetlands M-2
  - Landscape Infiltration M-3
  - Infiltration Berms M-4
  - Dry Wells M-5
  - Micro-Bio retention M-6
  - Rain Gardens M-7
  - Swales M-8
  - Enhanced Filters M-9

#### Performance Standards for Micro-Scale Practices

- Micro-scale practices used for new development shall promote runoff reduction and water quality treatment through infiltration, filtration, evapotranspiration, rainwater harvesting, or a combination of these techniques.
- Micro-scale filters used for new development shall be designed to promote recharge (e.g., enhanced filter) and be planted in accordance with a landscape plan.

#### 10.8.1 Rainwater Harvesting (M-1)

Rainwater harvesting practices intercept and store rainfall for future use. Stored water may be used for outdoor landscaping irrigation, car washing, cooling tower make-up water, and other non-potable water supply uses. The capture and re-use of rainwater promotes conservation and reduces runoff volumes and the discharge of pollutants downstream.

##### 10.8.1.2 Feasibility and Siting Criteria

Rainwater harvesting can be applied on residential, commercial, municipal, or industrial sites. For small-scale residential applications, rain barrels are typically used to provide storage of rooftop runoff. These systems are generally designed for outdoor use.

Larger storage tanks or cisterns are used in commercial or industrial applications. These systems use the captured rainwater for non-potable water supply, providing a year-round source. The complexity of the sizing, installation, and accessories of this type of application make it more realistic for commercial operations. Separate plumbing, pressure tanks, pumps, and backflow preventers are necessary for indoor applications.

- Storage tanks shall be designed to be watertight and all materials should be sealed with a water-safe, non-toxic substance.
- Storage tanks shall be protected from direct sunlight and shall be opaque to prevent the growth of algae.
- The top of underground tanks shall be located beneath the frost line.

Cisterns (Buried): Cisterns shall be constructed in buried conditions below the frost line or constructed inside a structure to prevent freezing. The intent is to allow for year-round use of stored cistern water. Cisterns may be ordered from a manufacturer or constructed on site. Typical materials used to construct cisterns are fiberglass, wood, metal, or reinforced concrete.

Rain barrels can be purchased or custom made from large, plastic (e.g., 55-gallon) drums.

Private: Cisterns and rain barrels are typically allowed only in private SWM systems.

### 10.8.1.3 Design Calculations

In addition to the calculations defined in Section 10.6, the design consultant shall provide  $ESD_V$  calculations in accordance with the following guidance.

$ESD_V$  provided by rain barrels and cisterns is the tank volume: This volume shall be sized to capture at least 0.2 inch of rainfall.

$$ESD_V \text{ (captured/provide)} = P_E \times R_V \times A / (12)$$

$$P_E = 0.2 \text{ inches or more}$$

$$R_V = 0.95$$

A = impervious area captured

Water Demand Calculations: The design consultant shall provide a water demand calculation to demonstrate that the demand for the stored water is balanced with the demand for the water re-use, and that the stored water will be used between normal storm events (assume storm events every 7 days)

Pump Calculations: The design consultant shall provide pump calculations and sizing, to verify that the cistern can be drained down within 8 hours.

### 10.8.1.4 Plan Preparation, Approvals, Specifications, and Details

WSSC Approval: If stored water from cisterns is proposed for use inside

the buildings (non-potable uses only), then design plans shall be submitted to WSSC for review and approval. WSSC is the plumbing jurisdictional authority for Prince George's County.

Health Department Approval: Cisterns will involve non-potable rainwater storage larger than a rain barrel. If stored water is intended for exterior use, the Health Department of Prince George's County shall be contacted at to determine if a permit is required.

Screens: Tanks shall be designed with screens to prevent mosquitoes and other insects from entering them.

Screens (Gutter): The use of gutter screens for rain barrels is required. They are needed to prevent the accumulation of leaves, twigs, and other wind-blown material from clogging the outlet of the rain barrel. The screens also need to be easily maintained by the homeowner.

Operation and Maintenance Notes: Owners of cisterns and rain barrels shall empty out the tanks between rain events (at least every 7 days). In addition, owners shall follow manufacturers' recommendations for maintenance, addition of chlorine pellets, and other instructions to prevent mosquito breeding and putrid storage water conditions. Use of stored water and emptying of rain barrels and cisterns is important to free up the capacity for future rain events. Rain barrels shall be disconnected in winter to prevent freezing.

Plumbing Design:

Most outdoor distribution piping associated with a cistern is gravity-fed or can be operated with a pump. For underground tanks or cisterns, a pump, pressure tank, and backflow preventer will be required. The design plans will need to include size and capacity of pumps and the distribution system. Hose bibs and sprinkler heads with locations need to be shown. Non-potable warning signs will be required.

## 10.8.2 Submerged Gravel Wetlands (M-2)

A submerged gravel wetland (SGW) is a small-scale filter using wetland plants in a gravel media to provide water quality treatment. Runoff drains into the submerged gravel wetland, at the surface, is distributed throughout the system, and discharges downstream from a pipe that collects water from the bottom of the device, because of water displacement and pressure. Pollutant removal is achieved in an SGW through biological uptake from algae and bacteria growing within the filter media. Wetland plants provide additional nutrient uptake. The physical and chemical treatment processes allow filtering and absorption of organic matter.

### 10.8.2.1 Feasibility and Siting Criteria

The SGW should be located at the edge of an environmental setting. Depending on individual site soil characteristics, a larger drainage area may be required to maintain saturated conditions within the wetland. An SGW can be located in limited spaces typically set aside for site landscaping such as traffic islands or roadway medians, provided the minimum drainage area of 1 acre can be provided. These systems are best suited for areas where a high water table or poorly drained soils are present. This practice will not be permitted on individual lots in a residential subdivision but may provide treatment for multiple lots, provided appropriate maintenance can be achieved.

For more information, use the following link for MDE design criteria for submerged gravel wetlands.

#### MDE Stormwater Design Guidance - SGWs

- Not Allowed if A/B soils upstream: If A or B soils are upstream of the SGW, other ESD facilities **MUST** be evaluated and determined to be not feasible before the SGW may be considered.
- C/D soils required: Locating SGWs in C/D soils is required.
- GWT: In no instance shall an SGW facility be permitted to have the groundwater table elevation at or above the top of gravel. If the GWT is within the gravel layer, this may result in difficult construction due to dewatering. The designer shall consider reducing the depth of gravel or shifting the location of the SGW. If this is not feasible and if the groundwater table is within the gravel layer, the volume of media storage may not be counted for any storage below the groundwater table.
- Drainage Area: The minimum drainage area is 1.0 acre. There is no maximum drainage area.
- Setback 25 feet from residential lot lines. If located in a residential area, the outside limits of the facility shall be located at least 25 feet from a residential lot.
- Not in Marlboro Clay Sites: They shall not be located above or on a Marlboro Clay or Christiana soil type.
- Adjacent to Environmental Setting: The SGW should be located in or adjacent to an environmental setting.
- Hotspot: If drainage to an SGW is from a hotspot, the facility shall be lined with an impermeable geotextile fabric.
- Since the facility should be located in an environmental setting, or adjacent to an environmental setting, coordination of the location with M-NCPPC Environmental Planning Section is necessary to ensure compatibility with adjacent riparian buffers. If located in a public park,



either current or proposed, the M-NCPPC DPR must be contacted to receive permission. If located in a floodplain, the design shall meet the DPIE requirements for floodplain disturbance.

- Setback from Buildings, Wells, and Septic: The practice shall be located at least 10 feet from any slab building, 20 feet from any building with a basement, 30 feet from water supply wells, and 25 feet from septic systems.
- Depth: The minimum depth of gravel shall be 18 inches, with a maximum depth of 48 inches.
- Small Pond Standards/Buffers: In most instances, the SGW facility should be designed with small enough drainage areas and volumes to be exempt from MD-378 small pond standards. However, if not exempt, then all small pond requirements shall be met and a 50-foot buffer from the 100-year WSEL adjacent to residential lots or a 25-foot buffer adjacent to commercial/industrial lots shall be provided.

#### 10.8.2.2 Geotechnical Analysis

Geotechnical analysis shall define the seasonally high GWT elevation within the SGW area. The Geotechnical Engineer shall confirm the presence of C and D soils within the SGW area. Soil borings shall be provided at the location of an outlet or riser structure for an SGW to confirm bearing capacity if a nonstandard structure is used. If the SGW size or volume triggers small pond standards, then soil borings are required per MD-378 requirements.

#### 10.8.2.3 Design Calculations

In addition to the calculations defined in Section 10.6, the design consultant shall provide  $ESD_v$  calculations in accordance with the following guidance.

$ESD_v$  target required shall be 100% of the total calculation – **Prince Georges County does not allow the use of 75% of  $ESD_v$  to meet the required storage.** See Section 10.6.

$ESD_v$  provided by SGWs shall be calculated based on *Maryland Design Manual* page 5.78, which provides the following guidance:

*“Pretreatment shall be provided for 10% of the total  $ESD_v$ ” – AND -*

*“Temporary ponding depth shall not be greater than the tolerance levels of wetland vegetation. Temporary storage of  $ESD_v$  may be provided above the gravel bed.” – AND -*

*“Storage calculations shall account for the porosity of the gravel media.”*

- Pretreatment volume shall be provided for 10% of the required  $ESD_v$ , provided in a forebay or below ground pretreatment chamber.

- The remaining 90% of the  $ESD_v$  shall be provided in the main SGW treatment area, with above-ground storage and gravel media storage. Above-ground storage volume shall be calculated based on the footprint of the SGW and with 24-inch maximum depth of water storage.

**$ESD_v$  Provided (above ground) = Footprint area x Depth provided**

- Media storage volume shall be calculated based on volume of gravel times 0.40 porosity above the GWT elevation. The media storage volume cannot be counted below the GWT identified in the geotechnical report.

**$ESD_v$  Provided (media) = V gravel (above GWT) x 0.40**

#### 10.8.2.4 Plan Preparation, Specifications, and Details

- Provide flow splitter to divert the  $ESD_v$  to the SGW forebay.
- Provide an access road at least 10 feet wide or other means to provide maintenance access if no adjacent private parking area or private road is available.
- If the SGW must comply with MD-378 small pond standards, provide all details required by PGSCD. See Chapter 9 for guidance.
- Observation wells shall be provided per DPIE requirements.
- Underdrains shall be provided, spaced 15 to 50 feet apart, Underdrain spacing shall be determined as follows: width between underdrain pipes = 2x flow length from inflow to the outflow distribution point and at least 5 feet from the edge of the device. The required length of perforated pipe shall be at least 5% of the surface area. Cleanouts shall be provided at the terminus and bends.

#### 10.8.2.5 Landscape Design Criteria

All plantings shall be in accordance with the Prince George's County landscape guidelines in Appendix 10-4, *M-NCPPC 2010 Landscape Manual*, and *Maryland Design Manual* Appendix A.

All landscape plans must be sealed by a Registered Landscape Architect. Since the plants are an integral part of the submerged gravel system, no changes to the approved landscape plan will be allowed unless an alternate plant list, prepared by a Registered Landscape Architect, has been approved by DPIE prior to installation. Since plant availability can change, including an alternate plant list on the landscaping plans is acceptable.

Buffer landscaping shall be provided between the SGW facility and adjacent residential lots, similar to SWM ponds. A minimum of three different types of

wetland species shall be provided.

### 10.8.3 Landscape Infiltration (M-3)

Landscape infiltration utilizes on-site vegetative planting areas to capture, store, and treat storm water runoff. Rainwater is stored initially, filtered through the planting soil and gravel media below, and then infiltrates into native soils. These practices can be integrated within the overall site design by utilizing a variety of landscape features for storage and treatment of storm water runoff. Storage may be provided in constructed planters made of stone, brick, and concrete, if the planter has a soil bottom for infiltration, or in natural areas excavated and backfilled with stone and topsoil.

#### 10.8.3.1 Feasibility and Siting Criteria

Landscape infiltration can be best implemented in residential and commercial land uses. Residential areas with compact housing such as clustered homes and townhouses can utilize the small green spaces for landscape infiltration. Because space in these instances may prevent the use of structural pretreatment, the drainage area to these practices should be limited to less than 10,000 sf.

- Soils: Landscape infiltration shall be proposed in A/B soils only.
- Distance to Groundwater Table: The bottom of the facility must be located 4 feet or more above seasonally high GWT.
- Not in Marlboro Clay Sites: Landscape infiltration shall not be located above or on a Marlboro Clay or Christiana soil type.
- Downstream Slope: Maximum downstream slope shall be 15%.
- Distance to Utility Lines: The landscape infiltration facility shall be sized and located a minimum of 5 feet horizontally from all utilities except a storm drain.
- Drainage areas less than 10,000 sf and a percent impervious less than 50% are most appropriate for landscape infiltration.
- Surface Area: The surface area of the BMP shall be at least 2% of the drainage area.
- Maximum Depth: Above-grade maximum depth of ponding shall be 12 inches.
- Setbacks: Landscape infiltration practices shall be located at least 10 feet from any slab building, 20 feet from any building with a basement, 30 feet from water supply wells, and 25 feet from septic systems. If the facility will also infiltrate and no underdrain is provided, then the practice shall be located at least 50 feet from confined water supply wells, and 100 feet

from unconfined water supply wells.

- Provide a 10-foot-wide grass filter strip adjacent to a slab building, to allow for sheet flow from downspouts, or provide a forebay.
- Pretreatment Practices may be incorporated into the design. A forebay for pretreatment is required when the drainage area exceeds 10,000 sf.
- Vertically Connected to Existing Ground: The surface bottom of the storage area must extend at least 3 inches into the surrounding existing ground, or sufficient gravel must be provided from the bottom of the facility to existing ground to use landscape infiltration.
- Media Material: Provide three layers of media as follows: 12 to 18 inches of planting soil, 6 to 12 inches of sand, and 12 inches of gravel.
- Private: Landscape infiltration is only permitted in private SWM systems.

#### 10.8.3.2 Geotechnical Analysis

Geotechnical analysis shall define the seasonally high GWT elevation within the landscape infiltration area. The design consultant shall confirm the presence of A/B soils within the landscape infiltration area.

#### 10.8.3.3 Design Calculations

In addition to the calculations defined in Section 10.6., the design consultant shall provide  $ESD_v$  calculations in accordance with the following guidance.

$ESD_v$  provided by Landscape Infiltration shall be calculated based on *Maryland Design Manual* page 5.83, which provides the following guidance:

*"The storage volume for the  $ESD_v$  shall be determined for the entire system and include the temporary ponding area, the soil, and the sand and gravel layers in the bottom of the facility."*

- **$ESD_v$  Provided (above ground) = Footprint area x 12" (or lesser depth proposed)**
- **$ESD_v$  Provided (media) =  $V_{\text{soil plus gravel plus sand media}} \times 0.40$**

Surface Area: Surface area meets or exceeds 2% of contributing drainage area.

#### 10.8.3.4 Plan Preparation Specifications and Details

- Geotextile fabric shall meet PE Type 1 non-woven per MSHA

Specification Standard 921.09.01 and shall be placed only on the sides of the facility with a maximum of 6 inches of overlap on the top or bottom of the device.

- The subsoil shall be roughened and not compacted.
- The filtering media or planting soil, mulch, and underdrain systems (when area is greater than 5,000 sf) shall conform to the specifications found in Appendix 10-3.
- For commercial or multi-family residential areas, an access road at least 10 feet wide, or other means to provide maintenance access, shall be provided if no adjacent private road or parking area is available.
- An observation well is required. It shall be set at grade for mowed areas and up to 6 inches above grade for landscaped areas.
- Provide bottom dimensions (length and width) on plan.
- All side slopes shall be 3:1 except within non-residential parking lot islands, which may be 2:1 or vertical if the drop is less than 6 inches.
- When an embankment is required and it is exempt from all MD-378 embankment criteria, the minimum top width shall be 2 feet.
- Any underdrain or storm drain outfall shall be located a minimum of 5 feet horizontally from any earthen spillway.
- Underdrains shall be provided, spaced 15 feet apart, and at least 5 feet from the edge of the device. The required length of perforated pipe shall be at least 5% of the surface area. Cleanouts shall be provided at the terminus and bends.
- Upstream storm drain systems generally shall be located 5 feet outside the limits of the bottom of the facility.
- The typical section shall include side slopes and top width.

#### 10.8.3.5 Landscape Criteria

All plantings shall be in accordance with the Prince George's County landscape guidelines in Appendix 10-4, *M-NCPPC 2010 Landscape Manual*, and *Maryland Design Manual* Appendix A. Facilities located in parking lots are generally expected to provide landscaping as the area will also need to meet the *M-NCPPC 2010 Landscape Manual*.

All landscape plans must be sealed by a Registered Landscape Architect. Since the plants are an integral part of the landscape infiltration system, no changes to the approved landscape plan will be allowed unless an alternate plant list, prepared by a Registered Landscape Architect, has been approved by DPIE prior to installation. Since plant availability can change, including an alternate plant list on the landscaping plans is acceptable.

#### 10.8.4 Infiltration Berms (M-4)

An infiltration berm is a mound of earth composed of soil and stone that is placed along the contour of a relatively gentle slope. This practice may be constructed by excavating upslope material to create a depression and storage area above a berm or earth dike. Stormwater runoff flowing downslope to the depressed area filters through the berm in order to maintain sheet flow. Infiltration berms should be used in conjunction with practices that require sheet flow (e.g., sheet flow to buffers) or in a terraced series on steeper slopes to prevent flow concentration.

##### 10.8.4.1 Feasibility and Siting Criteria

Infiltration berms may be used on gently sloping areas in residential or commercial land use conditions and area installed on open space or wooded areas. They must be installed along the contour in order to perform effectively. The purpose of this practice is to augment natural storm water drainage functions in the landscape by promoting sheet flow and dissipating runoff velocities.

- Not in Marlboro Clay Sites: Infiltration berms shall not be located above or on a Marlboro Clay or Christiana soil type.
- Stable Slopes: The design shall consider soils suitable to resist slope failure and slumping.
- Slopes: The maximum upstream and downstream slope shall be 10%.
- Berms shall be installed along the contour at a constant elevation and be level. If used as a terrace system, it is preferred to use terraces with a volume ratio between 0.8 to 1.2 for each terrace.
- Sheet Flow Length: Maximum allowable sheet flow length across pavement shall be 75 feet.
- Drainage area: The maximum drainage area to an infiltration berm shall be limited to 100 feet wide and up to 75 feet of paving or approximately

0.2 acres. Note that multiple infiltration berms set at the same contour elevation are permitted so larger areas may be controlled at one location.

#### 10.8.4.1.1 Geotechnical Analysis

No specific soil testing is required. The preference is to locate the infiltration berms on A, B, or C soils.

#### 10.8.4.3 Design Calculations

In addition to the calculations defined in Section 10.6, the design consultant shall provide calculations in accordance with the following guidance. ESD<sub>v</sub> provided shall be calculated based on *Maryland Design Manual* page 5.88.

ESD<sub>v</sub> Provided = Volume behind infiltration berm, up to the overflow elevation.

Small Pond Exemption: Infiltration berms shall be designed with minimal berm heights to ensure exemption from small pond requirements. In general, storage depth will be limited to 12 inches.

#### 10.8.4.4 Plan Preparation, Specifications, and Details

- Pretreatment practices may be incorporated into the design.
- Berm side slopes shall have a maximum ratio of 3:1.
- A minimum top width of 2 feet shall be provided.
- A berm will consist of a 6-inch layer of compacted topsoil with a gravel or aggregate interior meeting ASTM C-33 Size # 57.
- Excavate to a depth of 1 foot below the upstream invert beneath the berm and backfill with gravel.
- Grass Spillway Lining: The grass shall meet the criteria of seed mix 6, 7, 9, or 11 from MD-342. See *PGSCD Reference Manual*, pages II 36 – 66, for additional information. The seed mix shall be noted on the permit drawings.
- Grass Filter Strips: To control sheet flow in residential lots, the lawn area may serve as a grass filter strip adjacent to an infiltration berm with surface discharge.
- Provide bottom dimensions (length and width) on the plan.
- All side slopes shall be 3:1.
- Upstream storm drain systems generally shall be located 5 feet outside the limits of the bottom of the facility.

- The typical section shall include side slopes and top width.
- Gravel or Stone Diaphragm: Install gravel diaphragm 2 feet wide by 2 feet deep at the end of a concentrated inflow point that should run perpendicular to the flow path to promote settling. The gravel shall meet ASTM Specification C-33 Size #57 or larger stone.

#### 10.8.4.5 Landscape Criteria

The soil should be stabilized with a dense cover of vegetation.

### 10.8.5 Dry Wells (M-5)

A dry well is an excavated pit filled with gravel or a structural chamber that provides temporary storage of storm water runoff from rooftops. The storage area may be constructed as a shallow trench or a deep well. Rooftop runoff is directed to these storage areas and infiltrates the surrounding soils prior to the next storm event. The pollutant removal capability of dry wells is directly proportional to the amount of runoff that is stored and allowed to infiltrate.

#### 10.8.5.1 Feasibility and Siting Criteria

Dry wells can be used in both residential and commercial sites and are best suited for treating runoff from small drainage areas such as a single rooftop or downspout. Dry wells are not appropriate for treating runoff from large impervious areas such as parking lots. Successful application is dependent upon soil type and groundwater elevation.

The following additional conditions should be considered when designing dry wells:

- Soils: Dry wells shall be used in A/B soils only.
- Distance to GWT: Dry wells must be located 4 feet or more above the seasonally high GWT.
- Drainage area: The maximum drainage area to each dry well shall not exceed 1,000 sf to allow infiltration into the ground within 48 hours.
- Downstream Slope: Steep terrain affects the successful performance of a dry well. Installation on slopes greater than 20% should be avoided.
- Connection to Undisturbed Ground: A minimum of 50% of the dry well volume must be located within undisturbed soil.
- Not in Marlboro Clay Sites: Dry wells shall not be located above or on a Marlboro Clay or Christiana soil type.
- Setbacks: Dry well practices shall be located at least 10 feet from any slab



building, 20 feet from any building with a basement, 50 feet from confined water supply wells, and 100 feet from unconfined water supply wells.

- Cover: A maximum of 3 feet of cover shall be placed over the dry well.
- Private: Dry wells are only permitted in private SWM systems.

#### 10.8.5.2 Geotechnical Analysis

Geotechnical analysis shall define the seasonally high GWT elevation within the BMP area. A soil boring within 30 feet of the dry well and drilled at a similar site elevation will be considered sufficient for confirming the GWT, if the soil boring has been drilled deep enough (at least 4 feet below the bottom of the dry well). For larger sites, consult Table 10-1 and provide sufficient Geotechnical analysis. The design consultant shall confirm the presence of A/B soils within the dry well area.

#### 10.8.5.3 Design Calculations

In addition to the calculations defined in Section 10.6, the design consultant shall provide ESD<sub>v</sub> calculations in accordance with the following guidance.

ESD<sub>v</sub> provided by dry wells shall be calculated based on *Maryland Design Manual* page 5.92, which provides the following guidance:

*“The storage area for the ESD<sub>v</sub> includes the sand and gravel layers in the bottom of the facility. Storage calculations shall account for the porosity of the gravel and sand media.”*

Media storage volume shall be calculated based on volume of gravel and sand times 0.40 porosity.

**ESD<sub>v</sub> Provided = V(gravel and sand) x 0.40**

ESD maximum volume for dry wells shall be calculated as follows:

$$ESD_v \text{ max} = P_E \times R_V \times A / 12$$

$$P_E = 2.7''$$

$$R_V = 0.95$$

A = area of roof

ESD<sub>v</sub> maximum (for 1,000 square feet) = 214 cubic feet

#### 10.8.5.4 Plan Preparation, Specifications, and Details

- An observation well is required. It shall be set at grade for mowed areas and 6 inches above grade for landscaped areas.

- A 6-inch layer of clean, washed sand is used in place of geotextile fabric on the bottom of the dry well. Manufactured sand is not an acceptable substitute. (Note: The sand volume may be included in the dry well volume computations.)
- The dry well shall be filled with 1½-inch to 3-inch washed bank-run gravel or MSHA #2 or #3 double-washed gravel. Crushed bluestone or recycled concrete is not an acceptable substitute
- Geotextile fabric shall meet PE Type 1 non-woven per MSHA Specification Standard 921.09.01. The geotextile fabric shall be placed only on the sides of the facility and a maximum 6-inch overlap on the top and bottom.
- The typical detail in Appendix 10-6 may be used or modified as necessary to meet site conditions.
- If the discharge to a dry well is by means of a downspout, either a downspout surcharge pipe, overflow pipe, or pop-up emitter may be used. In all cases, a splash block shall be provided. All overflows shall be directed to a safe location that is unlikely to contribute to nuisance drainage problems such as wet lawns or seepage across sidewalks.
- The following are pretreatment practices that may be incorporated into the design.
  1. **Leaf Screens:** As part of the gutter system, leaf screens serve to keep the heavy loading of organic debris from accumulating in the dry well. This is a requirement for any downspout discharge connecting directly into the dry well.
  2. **Grass Filter Strips:** The lawn area may serve as a grass filter strip adjacent to a dry well, with surface discharge into residential lots to control sheet flow.
  3. **Gravel or Stone Diaphragm:** The gravel diaphragm should be installed at the end of a downspout or other concentrated inflow point that should run perpendicular to the flow path to promote settling. The gravel shall meet ASTM Specification C-33 Size #57 or larger stone.

#### 10.8.5.5 Landscape Criteria

The soil should be stabilized with a dense cover of vegetation.

### 10.8.6 Micro Bio retention (M-6)

Micro-bio retention practices capture and treat runoff from discrete impervious areas by passing it through a filter bed mixture of sand, soil, and organic matter. Filtered storm water is either returned to the conveyance system or partially infiltrated into the soil. Micro-bio retention practices are versatile and may be adapted for use where there is landscaping or grass.

#### 10.8.6.1 Feasibility and Siting Criteria

Micro-bio retention is a multi-functional practice that can be easily adapted for new and redevelopment applications in residential, commercial, and industrial projects. The major limitation to the use of this device is a high GWT or a hotspot area. By providing a liner and underdrain, this design may be used for nearly all situations. Stormwater runoff is stored temporarily and filtered in landscaped facilities shaped to take runoff from impervious areas of various sizes. Micro-bio retention provides water quality treatment as well as aesthetic value, and can be applied in concave parking lot islands, linear roadways or median filters, terraced slope facilities, residential cul-de-sac islands, and ultra-urban planter boxes.

- Distance to GWT: Micro-bio retention devices must be located above the seasonally high GWT and at least 4 feet or more above the seasonally high GWT if designed as an infiltration practice; otherwise, the facility shall be lined with an impermeable geotextile to prevent contamination of the groundwater.
- Drainage Area: The treated drainage area to any individual practice shall be 20,000 sf or less. The area of the device and supporting slopes is not included in the 20,000-sf limitation, but is included in the  $ESD_v$  maximum calculations. Larger systems shall be designed according to Chapter 9.
- Not in Marlboro Clay Sites: The device shall not be located above or on a Marlboro Clay or Christiana soil type.
- Setbacks: For residential zoned areas, the device must be located at least 10 feet from any slab building, 20 feet from any building with a basement, 30 feet from water supply wells, and 25 feet from septic systems. For commercial areas, the device may be closer, provided guidance from a Geotechnical Engineer is obtained and an underdrain is provided. If the facility will also infiltrate and no underdrain is provided, then the practice shall be located at least 50 feet from confined water supply wells and 100 feet from unconfined water supply wells. Lastly, for structures that are enclosed in a concrete structure such as a “planter box,” no setback criteria is required.

- Pre-treatment of runoff entering bio retention areas is useful to trap coarse sediment particles before they reach and prematurely clog the filter bed.
- Clearance to Utilities: A minimum of 5 feet of horizontal clearance shall be maintained between any utility except the storm drain and the perimeter for the facility. Light pole bases (private) shall extend to below the bottom of the device if located within the micro-bio retention storage area.

Private: In general, a micro-bio retention facility is only permitted in private SWM systems.

#### 10.8.6.2 Geotechnical Analysis

- Geotechnical analysis shall define the seasonally high GWT elevation within the micro-bio retention area. A soil boring within 30 feet of the BMP and drilled at a similar site elevation will be considered sufficient for confirming the GWT, if the soil boring has been drilled deep enough (at least 4 feet below the bottom of the micro-bio retention area).
- Infiltration testing and infiltration rates of 0.52 inch per hour or higher are required if the design consultant proposes to eliminate the underdrain.

### 10.8.6.3 Design Calculations

In addition to the calculations defined in Section 10.6 of the *Maryland Design Manual*, the design consultant shall provide additional calculations in accordance with the following guidance.

- ESD target (required) volume shall be 100% of the total calculation – **Prince Georges County does not allow for 75% of ESD<sub>v</sub> to meet the requirement of ESD<sub>v</sub>.** See Section 10.6 for additional information.
- ESD<sub>v</sub> provided by micro- shall be calculated based on *MDE ESD Process and Computations* July 2010, page 36, and pretreatment guidance in the *Maryland Design Manual* Chapter 3.
- Above-ground storage volume shall be calculated based on the footprint of the micro bio retention area and a 12" maximum depth of water storage. The surface storage of a pre-treatment forebay contributes to the overall ESD<sub>v</sub> provided.

**ESD<sub>v</sub> Provided (surface storage) = Footprint area x 12" (or lesser depth proposed)**

- Media storage volume shall be calculated based on volume of filter depth times 0.40 porosity.

**ESD<sub>v</sub> Provided (media) = V<sub>media</sub> x 0.40**

- Surface Area/Drainage Area Ratio: A minimum of 2% shall be provided.
- Small Pond Exemption: In general, storage depth will be limited to 12 inches, and the overall height of the berm is limited to 12 inches to qualify for this exemption. See the PGSCD Reference Manual pages II -11 and 12 for additional information.
- Overflow Structure/Pipe Sizing : Calculations shall be provided to demonstrate conveyance of the 10-year storm in an overflow structure. Overflow crest (structure openings) shall be set at the surface storage depth.

### 10.8.6.4 Plan Preparation Specifications, and Details

- Depth of Filter 24 to 48 inches
- Top of berm with required freeboard shall comply with the PGSCD Reference Manual requirements for an exempt or exempt by definition facility.
- Width of top of berm shall be a minimum of 2 feet.

- Pre-treatment measures must be designed to evenly spread runoff across the entire width of the micro-bio retention facility. If there is a concentrated inflow point, the following are suggested pretreatment options:
  1. **Pre-treatment Cells** (channel flow): Similar to a forebay, this cell is located at piped inlets or curb cuts leading to the bio retention area and consists of an energy dissipater sized for the expected rates of discharge. A storage volume equal to at least 15% of the total Treatment Volume (inclusive) with a 2:1 length-to-width ratio shall be provided. The cell may be formed by a stone check dam or an earthen or rock berm. Pretreatment cells do not need underlying soil media, in contrast to the main micro-bio retention cell.
  2. **Grass Filter Strips** (for sheet flow): Grass filter strips extend from the edge of pavement to the bottom of the bio retention basin at a 5:1 slope or flatter. Alternatively, provide a combined 5 feet of grass filter strip at a maximum 5% (20:1) slope and 3:1 or flatter side slopes on the bio retention basin.
  3. **Gravel or Stone Diaphragms** (sheet flow): A gravel diaphragm located at the edge of the pavement should be oriented perpendicular to the flow path to pretreat lateral runoff, with a 2- to 4-inch drop. The stone must be sized according to the expected rate of discharge, but in no case be smaller than ASTM C-33 size No. 57.
  4. **Gravel or Stone Flow Spreaders** (concentrated flow). The gravel flow spreader is located at curb cuts, downspouts, or other concentrated inflow points, and should have a 2- to 4-inch elevation drop from a hard-edged surface into a gravel or stone diaphragm. The gravel should extend the entire width of the opening and create a level weir at the bottom or treatment elevation.
- The filtering media or planting soil, mulch, and underdrain systems shall conform to the specifications found in Appendix 10-3.
- Provide bottom dimensions (length and width) on plan.
- All side slopes shall be 3:1 except within non-residential parking lots islands, which may be 2:1 or vertical if drop is less than 6 inches.
- When an embankment is required and it is exempt from all MD-378 embankment criteria, the minimum top width shall be 2 feet.

- Any underdrain or storm drain outfall shall be located a minimum of 5 feet horizontally from any earthen spillway.
- Upstream storm drain systems generally shall be located 5 feet outside the limits of the bottom of the facility.
- The typical section shall include side slopes and top width.
- An underdrain is required for all bio retention facilities unless soil tests indicate that permeable soils with an infiltration rate greater than 0.52 inch/hour are present and there is no reasonably feasible method of connecting an underdrain to a storm drain or free outlet.
- An underdrain shall be located in a 12-inch thick gravel layer meeting ASTM-C-33 size No. 57. The pipe shall be set at a 0% slope and shall be located at least 4 inches above the subgrade, and there shall be at least 2 inches of cover to the layer above.
- Underdrains shall be provided, spaced 15 feet apart and at least 5 feet from the edge of the device. The required length of perforated pipe shall be at least 5% of the surface area. Cleanouts shall be provided at the terminus and bends.
- Access for cleaning all underdrain piping is required. Cleanouts shall be located at the end of all pipe runs and shall be level with the top of the mulch. All cleanouts shall have a removable cap. They may also be used as observation wells.
- The soil media phosphorus “P-Index” shall range between 10 and 30. This will increase phosphorus uptake without much ponding.
- An access road at least 10 feet wide or other means to provide maintenance access if no adjacent private roadway or private parking area is available. Access from a public road is not acceptable if a lane of traffic will be blocked.
- An observation well is required and shall be set at grade for mowed areas and 6 inches above grade for landscaped areas.

#### 10.8.6.5 Landscape Criteria

All plantings shall be in accordance with the Prince George’s County landscape guidelines in Appendix 10-4, M-NCPPC 2010 Landscape Manual, and Maryland Design Manual Appendix A. Facilities located in parking lots are generally expected to provide landscaping as the area will also need to meet the M-NCPPC 2010 Landscape Manual.

All landscape plans must be sealed by a Registered Landscape Architect. Since the plants are an integral part of the micro-bio retention system, no changes to the approved landscape plan will be allowed unless an alternate plant list, prepared by a Registered Landscape Architect, has been approved by DPIE prior to installation. Since plant availability can change, including an alternate plant list on the landscaping plans is acceptable.

- Trees shall be located at the perimeter of the device and in any event, not located within 3 feet of underdrains.
- Trees at least 1-inch caliper shall be planted no denser than 1 per 250 sf of facility.
- Woody vegetation shall not be located near inflow.
- Perennial grasses and other such low-maintenance but attractive landscape materials are preferred.
- Generally turf grass is not permitted; however, in those cases where it is allowed (sod is **NOT** acceptable), the 3-inch mulch layer will be substituted for with 3 inches of sandy loam or loamy sand texture with less than 5% clay content, a pH between 6 and 7, and an organic content greater than 2%.
- Landscape designers shall consider overhead telecommunication and electric lines when selecting trees to be planted.

#### 10.8.7 Rain Gardens (M-7)

A rain garden is a shallow, excavated landscape feature or a saucer-shaped depression that temporarily holds runoff for a short period of time. Rain gardens typically consist of an absorbent-planted soil bed, a mulch layer, and planting materials such as shrubs, grasses, and flowers. An overflow conveyance system is required to pass the larger storms. Captured runoff from downspouts, roof drains, pipes, swales, or curb openings temporarily ponds and slowly filters into the soil over 24 to 48 hours.

##### 10.8.7.1 Feasibility and Siting Criteria

Rain gardens can be primary or secondary practices on residential, commercial, industrial, or institutional sites. This practice is typically used to treat runoff from small impervious areas like rooftops, driveways, and sidewalks. Rain gardens can also be used in retrofitting and redevelopment applications and in series where existing slopes require energy dissipation.

- Distance to GWT: Must be located above the seasonally high GWT and at least 4 feet or more above seasonally high GWT if designed as infiltration practice.



- Drainage Area: The treated drainage area (maximum) to any individual practice shall be 2,000 sf if on a single residential lot and up to 10,000 sf for non-residential zoned areas. The area of the device and supporting slopes is not included in this square footage limitation, but is included in the ESD<sub>v</sub> maximum calculations. Larger systems shall be designed according to Chapter 9.
- Not in Marlboro Clay Sites: The device shall not be located above or on a Marlboro Clay or Christiana soil type.
- Private: Only permitted in private SWM systems.
- Pre-treatment of runoff entering rain garden areas is useful to trap coarse sediment particles before they reach and prematurely clog the filter bed.
- Clearance to Utilities: Maintain a minimum of 5-foot horizontal clearance between any utility and the perimeter for the facility.
- Depth and Location: A rain garden should be located in full to partial sun; and depth shall provide a 3-inch layer of mulch and a 12-inch layer of planting soil. Maximum allowable surface storage depth is 6 inches.
- Underdrains: If the soil is HSG C or D, an underdrain should be provided.
- Slopes: Rain gardens require relatively flat slopes (< 5%) to accommodate runoff filtering through the system. Some design modifications can address this constraint through the use of infiltration berms, terracing, and timber or block retaining walls on moderate slopes. Downstream slopes above 15% are not acceptable.
- Setbacks: A rain garden shall be located at least 10 feet from any slab building, 20 feet from any building with a basement, 30 feet from water supply wells, and 25 feet from septic systems. If the facility will also infiltrate and no underdrain is provided, then the practice shall be located at least 50 feet from confined water supply wells and 100 feet from unconfined water supply wells.
- Private: In general, they are only permitted in private SWM systems.

#### 10.8.7.2 Geotechnical Analysis

- Geotechnical analysis shall define the seasonally high GWT elevation within the BMP area. A soil boring within 30 feet of the rain garden and drilled at a similar site elevation will be considered sufficient for confirming the GWT if the soil boring has been drilled deep enough (at least 2 feet below bottom of rain garden).

- Infiltration testing and infiltration rates of 0.52 inch/hour or higher are required if the designer intends to eliminate the underdrain.

### 10.8.7.3 Design Calculations

In addition to the calculations defined in Section 10.6, the design consultant shall provide additional calculations in accordance with the following guidance.

- ESD<sub>v</sub> target (required) shall be 100% of the total calculation – **Prince George’s County does not allow for 75% of ESD<sub>v</sub>**. See Section 10.6.
- ESD<sub>v</sub> provided by a rain garden shall be calculated based on MDE ESD Process and Computations July 2010, page 19.
- Above-ground storage volume shall be calculated based on the footprint of the rain garden area and with 2-inch minimum/6-inch maximum depth of water storage. The surface storage of a pre-treatment forebay, if provided, contributes to the overall ESD<sub>v</sub> provided.

**ESD<sub>v</sub> Provided (surface storage) = Footprint area x 6" (or lesser depth proposed)**

- Soil media storage volume shall be calculated based on volume of filter depth times 0.40 porosity.

**ESD<sub>v</sub> Provided (media) = V<sub>media</sub> x 0.40**

- Surface Area/Drainage Area Ratio: Minimum 2% of contributing drainage area.
- Small Pond Exemption: This BMP shall be designed with minimal berm heights to ensure exemption from small pond requirements. Provide exemption request and calculations. In general, storage depth will be limited to 12 inches, with a maximum embankment ponding of 12 inches.

### 10.8.7.4 Plan Preparation Specifications, and Details

- All public utilities, including water and sewer service connections, shall be located at least 5 feet from the edge of any rain garden.
- Runoff shall enter, flow through, and exit rain gardens in a safe and non-erosive manner. Energy dissipation shall be provided for downspout discharges using a plunge area, rocks, splash blocks, stone dams, etc. Runoff shall enter a rain garden at the surface through grass swales and/or a gravel bed. A minimum internal slope of 1% should be maintained, and a shallow berm surrounding the rain garden is recommended to avoid short-circuiting. For sloped applications, a series of rain gardens may be used as “scalped” terraces, and the series of rain

gardens shall convey water in a non-erosive manner.

- **Pretreatment Practices:**
  1. **Leaf Screens:** As part of the gutter system, leaf screens serve to keep heavy loading of organic debris from accumulating in the Rain Garden cell.
  2. **Grass Filter Stripes:** For residential lots use sheet flow, where the lawn area may serve as a grass filter strip adjacent to a rain garden.
  3. **Gravel or Stone Diaphragm:** Install a 1- to 2-foot-wide gravel diaphragm at the end of concentrated inflow points that should run perpendicular to the flow path to promote settling and to ensure runoff will flow in a safe and non-erosive manner. The gravel shall meet ASTM C-33 Size #57.
- Runoff for the 1-year storm shall enter the facility in a non-erosive manner (less than 2 fps). Inflow may be through depressed curbs with wheel stops, curb cuts, level spreaders, bubblers, or conveyed directly using downspouts, covered drains, catch basins, overland flow, or other acceptable conveyance methods. Particular care must be taken to prevent erosion of the surface mulch layer.
- An observation well is required, and it shall be set at grade for mowed areas and 6 inches above grade for landscaped areas.

#### 10.8.7.5 Landscape Criteria

All plantings shall be in accordance with the Prince George's County landscape guidelines in Appendix 10-4, M-NCPPC 2010 Landscape Manual, and Maryland Design Manual Appendix A.

All landscape plans must be sealed by a Registered Landscape Architect. Since the plants are an integral part of the rain garden system, no changes to the approved landscape plan will be allowed unless an alternate plant list, prepared by a Registered Landscape Architect, has been approved by DPIE prior to installation. Since plant availability can change, including an alternate plant list on the landscaping plans is acceptable.

- The planting soil and mulch shall conform to the specifications found in Appendix 10-3 or MSHA Specification Section 920 under Landscaping.
- The use of native plants is encouraged, but they may not be appropriate in all situations. While no hard planting rule exists, the plants should be a mix of trees, shrubs, and herbaceous materials. Because of the relatively shallow depth of the planting media, it is preferable to plant the surface

of the facility with herbaceous materials only.

- Trees and shrubs should be planted at the perimeter of the facility. The number and types of tree and shrub plantings for the system may vary, especially where aesthetics or other considerations such as screening or shading are critical to site development.
- The planting design should anticipate that the mature canopy of trees and shrubs, together with the areas planted with herbaceous materials, should cover at least 85% of the rain garden practice.
- Trees shall be a minimum of 1-1/2 inch caliper, shrubs shall be a minimum 2-gallon size, herbaceous flowering perennials shall be a minimum 1-quart size, and grasses and grass-like perennials shall be at minimum 2-inch plugs.
- Turf grass is not acceptable in rain gardens.

### 10.8.8 Swales (M-8)

Swales are channels that provide conveyance, water quality treatment, and flow attenuation of storm water runoff. Swales provide pollutant removal through vegetative filtering, sedimentation, biological uptake, and infiltration into the underlying soil media. Three design variants covered in this section include grass swales, wet swales, and bio-swales. Implementation of each is dependent upon site soils, topography, and drainage characteristics.

#### 10.8.8.1 Feasibility and Siting Criteria

Swales may be used for primary or secondary treatment on residential, commercial, industrial, or institutional sites. Swales may also be used for retrofitting and redevelopment. The linear structure allows their use in place of curbs and gutters along highways, residential roadways, and property boundaries. Wet swales are ideal for treating highway runoff in low-lying or flat terrain with high groundwater. Bio-swales may be used in all soil types due to the use of an underdrain. Grass swales are best suited along highway and roadway projects. Swales may be placed in fill soils provided underdrains are used.

- Bottom Width: Swales shall be at least 2 feet wide and no more than 8 feet in width. The side slopes shall be at least 3:1
- Surface Area/Drainage Area Ratio: The surface area ( $A_f$ ) shall be at least 2% of the contributing drainage area.
- Additional Stone Storage: Bio swales may not be “enhanced” by placing additional stone storage below the underdrain invert.

- Slopes: Grass swales with steep slopes >4% are not acceptable to use. In some cases, a slope up to 5% will be considered if no other options are feasible.
- Hotspots: Swales should not be used to treat hotspots that generate higher concentrations of hydrocarbons, trace metals, or toxicants than are found in typical storm water runoff that may contaminate groundwater.
- Setback to Lot Lines/Buildings: The minimum setback or distance from the top of the device to a lot line for an adjacent owner shall be 5 feet. This applies to both sides of the device if the swale is located in a parcel. A minimum 10-foot setback from any building is required. The 10-foot criterion does not apply to swales adjacent to roads.
- Distance to GWT: Dry and wet bios wales must be located 4 feet above the seasonally high GWT. Wet swales shall be designed such that the invert of the swale is above and intercepts the GWT.
- Drainage Area: The treated drainage area to any individual practice shall not exceed 1 acre.
- Soils: Use dry swales and bios wales in A/B/C soils. Use wet swales in C/D soils.
- Not in Marlboro Clay Sites: The device shall not be located above or on a Marlboro Clay or Christiana soil type.
- Pre-treatment: Runoff can be pre-treated before it enters swale areas. This step is useful to trap coarse sediment particles before they reach and prematurely clog the filter bed.
- Clearance to Utilities: It is likely that utilities, in particular water or sewer service connections, shall be installed below water quality swales. Coordinate swale design with depth of water or sewer connections to maintain 4 feet of vertical clearance from the ground and 2 feet for all other utilities except a storm drain. If allowed by the utility company, light pole bases (private) shall extend to below the bottom of the device. Otherwise, allow for proper horizontal clearances for street lights.
- Private: Swales are allowed in private SWM systems, and in public SWM systems on a case-by-case basis.

#### 10.8.8.2 Geotechnical Analysis

Geotechnical analysis shall define the seasonally high GWT elevation within the swale area. The design consultant shall confirm the presence of A/B/C/D soils within the swale area and select swale type accordingly. Infiltration testing shall be provided for bios wales if attempting to eliminate the underdrain.

### 10.8.8.3 Design Calculations

Storage provided in excess of that required to treat the runoff for the 1-year, 24-hour design storm shall not be counted. In addition to the calculations defined in Section 10.6, the design consultant shall provide additional calculations in accordance with the following guidance.

- $ESD_v$  target (required) shall be 100% of the total calculation – **Prince George’s County does not allow for 75% of  $ESD_v$** . See Section 10.6.
- $ESD_v$  provided by swales shall be calculated based on the MDE *ESD Process and Computations* July 2010, page 35. The provided volume is the aggregate of surface storage plus media storage.
- For a dry swale, the aboveground storage volume shall be calculated based on the length of the swale times the average cross-sectional area of storage limited to a maximum of 4 inches or the volume developed behind a check dam.
- Bio swales may account for the above-ground storage volume provided a check dam is used. The volume of storage shall be calculated based on the length of the swale times the average cross-sectional area of storage developed behind a check dam. The maximum depth shall be 12 inches of water storage behind a check dam.

**$ESD_v$  Provided (surface storage) = Swale Length x Avg. Cross-Sectional Area**

- Media storage volume shall be calculated based on volume of filter depth times 0.40 porosity. Media storage only applies to bios wales; media depth is limited to 24 to 48 inches.

**$ESD_v$  Provided (media) =  $V_{media}$  x 0.40**

- **$ESD_v$  Max** - Storage provided in excess of that required to treat runoff for the 1-year, 24-hour design storm shall not be counted toward the total. Calculate  $ESD_{max} = 2.7'' \times R_v \times A/12$  and ensure that swale is not oversized.
- Storage within the underdrain stone shall not be counted.
- Surface Area/Drainage Area Ratio: A minimum area ratio of 2% shall be provided.
- Channel Conveyance Sizing: Calculations shall be provided to demonstrate conveyance of the 1-year storm at non-erosive velocities of 1 fps for a Manning’s “n” value of 0.15.

- Freeboard: A minimum of 9 inches of freeboard shall be provided from the 10-year WSEL to the edge of paving or bottom of curb.

#### 10.8.8.4 Plan Preparation Specifications, and Details

- Stormwater discharged into and through swales must flow in a non-erosive manner (less than 1 fps for the 1-year storm). Inflow may be via sheet flow, depressed curbs with wheel stops, curb cuts, level spreaders, over grass, or other acceptable conveyance methods.
- Check dams or weirs may be used to enhance storage and channel roughness or provide grade control in steeper applications. They are required for wet swales. Wood, concrete, or similar materials are acceptable for use as check dams. Where used, these structures should be anchored into the swale wall and notched to allow passage of larger design storms.

For higher capacity roads, a clear zone from concrete or similar material weirs may be required to comply with AASHTO criteria.

Plunge pools or other energy dissipation may be required where the elevation difference between the tops of weirs to the downstream channel invert is a concern. If a check dam is used, it shall be spaced so the top of the ESD<sub>v</sub> storage is no higher than the toe of the upstream check dam.

- Planting media shall be between 24 and 48 inches deep.
- Channel slope shall not exceed 4%, although up to 5% may be considered on a case-by-case basis.
- Curb Cuts and Backless Inlets: When swales are proposed in curb and gutter road conditions, the discharge of runoff from the roadway shall be diverted to the swale through a series of curb cuts or backless inlets. MSHA Detail 378-05 may be utilized.
- Underdrains shall be provided in bios wales.
- Pea Gravel Diaphragm: A 6-inch-wide by 12-inch-deep diaphragm may be provided at the edge of the roadway where runoff enters the swale.

#### 10.8.8.5 Landscape Criteria

A landscape plan shall specify proper grass or wetland plantings based on the design variant chosen and anticipated hydrologic conditions along the channel in Appendix 10-4. Native species are best for survival and enhancing biodiversity and wildlife. The landscape plan must be sealed by a Registered Landscape Architect.

### 10.8.9 Enhanced Filters (M-9)

An enhanced filter is a modification applied to specific practices (e.g., micro-bio retention) to provide water quality treatment and groundwater recharge in a single facility. This design variant uses a stone reservoir under a conventional filtering device to collect runoff, remove nutrients, and allow infiltration into the surrounding soil. The design criteria of the device that the enhanced filter is supplementing shall be used.

The structural storm water filtering systems in Chapter 9 and the micro-filtering structures described above may be modified relatively easily for most development projects. Depending on soil conditions, a stone reservoir can be sized appropriately to provide Rev for the drainage area to the system. These practices are subject to the same constraints and design requirements as conventional and micro-scale filters.

#### 10.8.9.1 Feasibility and Siting Criteria

- Distance to GWT: Structures must be located at least 4 feet or more above the seasonally high GWT if they are designed as infiltration practice.
- Infiltration Rate: Practice is a combination of filtration and infiltration. The bottom of the facility is intended to infiltrate. Therefore, practice feasibility is based on an infiltration rate of 0.52 inches per hour or greater.

#### 10.8.9.2 Geotechnical Analysis

Geotechnical analysis shall define the seasonally high GWT elevation within the BMP area. The design consultant shall confirm the presence of soils that can infiltrate at rates in excess of 0.52 inch per hour based on infiltration testing.

#### 10.8.9.3 Design Calculations

In addition to the calculations defined in Section 10.6, the design consultant shall provide additional calculations in accordance with the following guidance.

- ESD<sub>v</sub> target (required) shall be 100% of the total calculation - **Prince Georges County does not allow for 75% of ESD<sub>v</sub>**. See Section 10.6 for additional information.
- ESD<sub>v</sub> provided by enhanced filter shall be calculated based on volume of filter depth times 0.40 porosity.

$$\text{ESD}_v \text{ Provided (media)} = V \text{ gravel} \times 0.40$$

#### 10.8.9.4 Plan Preparation Specifications and Details for Enhanced Filters (M-9)

- Coordination with Utilities: Enhanced filters shall be sized and located to provide 5 feet of horizontal clearance and 1 foot of vertical clearance from



all public utilities, including sewer and water lines or connections. Designs may need to include special protection if underground utilities cross through enhanced filters.

- Underdrain: An underdrain shall be located in the gravel layer meeting ASTM C-33 Size #57. The pipe shall be 6 inches in diameter set at a 0% slope and located at least 4 inches above the subgrade. There shall be at least 2 inches of cover to the layer above. The distance from the underdrain to the edge of the device shall not exceed 5 feet. The distance between each parallel underdrain shall be no more than 15 feet.
- Cleanouts: Access for cleaning all underdrain piping is needed. Watertight cleanouts for each pipe shall be level with the top of the mulch. All cleanouts shall have a removable cap. They may also be used as observation wells.
- Observation Well: An observation well is required and shall be set at grade in turf areas and up to 6 inches above grade for landscape areas.

---

## Chapter 11 EASEMENTS AND RIGHTS-OF-WAY

### 11.1 Introduction

All easements or rights-of-ways for storm drain, SWM, surface drainage, and floodplain must be submitted to the DPIE District Engineer for approval. Any easement required by Prince George's County that has been recorded in land records will be shown on the final plat and the liber and folio of the easement reflected on the final plat. Easements required for storm drains, SWM, and surface drainage are not approved by the Planning Board as a part of the final plat process but are approved by the County as a part of the SWM plan review process. The District Engineer will review easements prepared as stand-alone legal descriptions. Easement documents identify, in the body of the easement document, the rights granted, while the underlying property ownership remains with the property owner. The processing of easements can be seen in the flowchart in Appendix 11-1.

#### 11.1.1 Storm Drain Easements

Storm drain easements are required for all public storm drain systems outside of a public street right-of-way. In some cases, an easement to supplement the public right-of-way is required when a pipe is too close to the edge of the right-of-way. The following provides guidance on the location and width of storm drain easements.

- A. Utility lines, both wet and dry, are often designed parallel with other utility lines, and owners of the facilities often have separate easements. Proposed storm drain easements are not created by the final plat process, but are reviewed and approved by the County as separate documents. Existing easements are reflected by liber and folio on the final plat. Easements are conveyed by deed with a legal description and a metes and bounds description for the easement area. In the case of a proposed easement that overlaps an existing easement, the approval from the property owner is required and may be required from the holder of the existing easement. Storm drain easements may cross in a perpendicular or near-perpendicular direction, but may not overlap a public utility easement in a parallel direction.
- B. For projects that consist of private roads, alleys, or parking lots, an access easement from a public road to the public storm drain easement will be required.
- C. Since the depth of the storm drain pipe is variable, the required storm drain easement width shall be based on the highest cover over the pipe.
- D. Where proposed conditions warrant, the minimum storm drain easement width may be increased if the following conditions exist:
  1. Slopes greater than 20% in open space areas;
  2. Limited access from one direction;
  3. Extreme distance from a public right-of-way or access easement; and

- 4. Restricted work/stockpile space.
- E. Table 11-1 defines required and standard storm drain easement widths for circular pipe:

**Table 11-1 Permanent Easement Width for Storm Drain Pipe Installation**

Pipe Diameter Inches	Pipe Depth (feet)										
	4	5	6	7	8	10	12	14	16	18	20
	REQUIRED EASEMENT WIDTH IN FEET										
6-10	15	15	15	15	15	20	X	X	X	X	X
12 -15	20	20	20	20	20	24	27	31	35	39	43
18-24	25	25	25	25	25	29	33	37	41	45	49
27-36	30	30	30	30	30	34	38	42	46	51	54
42-48	X	X	35	35	35	39	43	47	51	55	59
54-60	X	X	X	40	40	44	48	52	56	60	64
66-72	X	X	X	45	45	49	53	57	61	65	69
78-84	X	X	X	X	50	50	50	54	58	62	66
90-96	X	X	X	X	55	55	55	59	63	67	71
102-108	X	X	X	X	60	60	60	64	68	72	76

- F. For storm drain pipe that is deeper than 20 feet, increase storm drain easement width by 4 feet for each additional foot of depth.
- G. For parallel dual, triple, and other multiple storm drain pipe design, use the illustration in Appendix 11-2 to determine the easement.
- H. For elliptical pipe, use the equivalent round pipe size.
- I. For open concrete, gabions, and riprap channels, use the illustration in Appendix 11-3 to determine the required easement width.
- J. For riprap at the beginning or end of a culvert, extend the easement a minimum of 5 feet beyond the limits of the riprap in all directions.
- K. For outfalls, extend the outfall offsite in accordance with Section 8.3.7 to the downstream property line if within an environmental setting, or to the stream channel. In no case shall a “spite” strip be created. In other words, the drainage system easement should connect to the exterior property line, to allow future owners to connect to the storm drain system through the easement. The easement configuration should be squared as much as feasible, to the maximum width for the outfall pipe or riprap, even if this width is wider than the normal requirement for a pipe.

- L. A minimum clearance of 5 feet from the outside of the pipe or structure shall be provided to the right-of-way line or an easement is required.
- M. When a pipe requires an easement because the pipe is too close to the right-of-way, the easement line shall be based on 1/2 the required width, measured from the centerline of the pipe. Only the area outside the public right-of-way will be in a storm drain easement. See Appendix 11-4 for an example. The easement may **NOT** overlap a public utility easement. If this is not possible, additional manholes may be required to maintain the 5-foot minimum clearance.

### 11.1.2 SWM Easements

SWM easements are required for all public SWM facilities and associated underground pipe systems, swales, etc., maintained by the County and located outside the public right-of-way. This includes providing an easement for any required access to the facility. Required criteria for establishing the SWM easement are as follows:

- A. The entire SWM facility, including embankment and appurtenances, backside slopes up to at least the top of dam elevation and design, high water level, non-woody buffer, outfall pipe and riprap, and access road shall be included in the SWM easement.
- B. Storm drain easements may terminate at the SWM easement. They do not need to extend into the SWM easement area.
- C. SWM easements may overlap a storm drain easement or vice versa, but are not required to do so.
- D. Retaining walls are not permitted within the 100-year WSEL for an SWM facility, as they will not be maintained by the County and therefore cannot be included in the easement.
- E. The easement delineation should minimize the number of line courses to describe the easement.
- F. Generally using arcs to describe an easement is not acceptable unless they follow an existing easement or right-of-way that includes an arc.
- G. The easement shall be extended to the stream or downstream property limits. The easement should also be squared off as much as possible to the maximum width for the outfall pipe or riprap, even if this width is wider than the normal requirement for a pipe.
- H. See Table 11-1 for the minimum easement width requirements for a pipe outfall.

### 11.1.3 Surface Drainage Easements

A surface drainage easement is required whenever concentrated flow crosses a third property line according to County Code Sec. 32-151(b).

- (b) *Concentrated surface drainage from each lot or parcel shall discharge directly, or through no more than one (1) adjacent lot unless suitable easements are granted to accommodate its flow into a publicly maintained drainage system, street or continuously flowing natural watercourse. Easements may not be required if, in the opinion of the Director, it can be demonstrated by a Maryland Registered Professional Engineer that the concentrated surface drainage is insignificant and/or will not adversely affect adjacent properties.*

The property line could include lots, parcels, or outlots. The surface drainage easement shall be a minimum of 15 feet wide and will terminate at a public right-of-way, floodplain, or storm drain easement. The easement shall encompass a swale area as defined by the grading plan, and the easement shall be a minimum of 5 feet from any house or other type of permanent habitable structure. **Surface drainage easements for projects shall be recorded prior to the issuance of a building permit for the affected lots.** In some instances, the County may require recordation of surface drainage easements before issuing site development permits. Situations that may require recordation include swale systems that convey significant drainage areas.

The property owner is responsible for any maintenance inside of the easement.

### 11.1.4 Floodplain Easements

When a 100-year floodplain is delineated in any development project, the applicant is required to provide an easement that encompasses the approved 100-year floodplain limits. In general, the floodplain easement is delineated on the final plat. A separate easement document that sets forth the rights, responsibilities, and liabilities of the property owner and the County is required as a part of the SWM approvals.

- A. Prior to approving an easement area, an approved floodplain delineation is required.
- B. The approved floodplain study, used as the basis for the floodplain delineation, must be recognized and approved by DPIE (i.e., according to current FEMA regulations, SWM Technical Group Comprehensive Management Plan, and Adopted Private Study). For further guidance on floodplain studies and the approval process, see Chapter 4.
- C. The easement delineation should minimize the number of line courses required to describe the easement.
- D. Generally using arcs to describe an easement is discouraged unless it is following an easement or right-of-way that includes an arc.

- E. DPIE will review the design plan and final plat against the approved floodplain delineation. It is the design consultant's responsibility to ensure that all plans match.
- F. A waiver from the easement may be requested in accordance with County Code Section 32-205 (c):

*The dedication or easement shall meet the County requirements for form and content and shall be recorded among the Land Records of the County. The easement requirement may be waived when, in the opinion of the Department, the waiver would not compromise any public or private interests including the rights of the landowners, safety, and environmental protection; would not conflict with any Federal, State or County laws; and the establishment of an easement would constitute an unreasonable hardship on the applicant. A waiver may be granted only if the Department finds that the applicant has demonstrated the following:*

- (1) *The property is already essentially developed and occupied by the applicant; or*
  - (2) *The proposed disturbed area is less than twenty percent (20%) of the total area of a single residential lot; and*
  - (3) *The floodplain is clear of proposed improvements, including access roads, to the extent the floodplain area is not used in conjunction with the proposed improvements; and*
  - (4) *The floodplain is not likely to increase in the future nor would it be damaged by continuing stream flows or flooding that may be caused, in part, by the existence of downgraded or upgraded public storm drain systems or storm water management facilities.*
- F. The floodplain easement may be recorded by one of two methods.
    - 1. Granting of the floodplain easement limit at the time of final plat, with a written legal easement document recorded amongst the Land Records of Prince George's County setting forth the rights, responsibilities, and liability of the parties.
    - 2. Granting of the floodplain easements by written legal document, processed through the DPIE Rights-Of-Way Unit and recorded amongst the Land Records of Prince George's County, Maryland and including an exhibit delineating the extent of the easement limit.

- G. For a floodplain easement recorded in the land records, the property owner is restricted from disturbing, grading, and building within the floodplain easement, unless otherwise specified in the recorded easement language.
- H. If a floodplain easement is shown on the record plat, the County can regulate improvements per County Code Sec. 32-202 to 32-213.

#### **11.1.5 Woodland Conservation Easement**

Woodland conservation easements are required by County Subtitle 25 and the *Environmental Technical Manual*. The woodland conservation program is administered by M-NCPPC, to protect existing forested area and riparian areas. Tree conservation easements are shown on a Type 2 Tree Conservation Plan (TCP2), and the liber and folio of the easement is noted on the TCP2. The easement document with legal description and metes and bounds description of the easement area is required prior to certification of the TCP2. The *Environmental Technical Manual* establishes the criteria for the required information to prepare and process a woodland conservation easement. Additional information may be found in the *Environmental Technical Manual*.

It is the responsibility of DPIE to enforce the terms of the conservation easement by issuing a violation to the property owner. The M-NCPPC Environmental Section will provide direction to remedy the violation.

#### **11.1.6 Access and Grading Easement/Letter of Permission**

An access and grading easement or letters of permission are required to disturb property not owned by the property owner, and for activities that involve clearing, trespassing, access, or grading an adjacent property. The preferred approach to processing such easements is to prepare a legal description with metes and bounds description, sketch of the area affected, and a legal document outlining the rights granted by the property owner to the permittee. This document is then recorded in the Land Records of the County. If the easement does not affect County property, it is not necessary for the County to review or approve the easement.

Alternatively, it is permissible to obtain a letter of permission from the adjacent property owner. It must be signed by both parties and must be included on the Grading, Erosion, and Sediment Control Plan that incorporates the disturbed area.

Any revertible easement obtained by the applicant must be recorded; the procedures are the same as for a grading easement.

#### **11.1.7 Easement or Right-of-Way Release/Vacation**

If an existing easement or road right-of-way that is controlled by the County is no longer required by the County, a release process or vacation petition (County Code Sec. 24-112) process is required.

The easement release process for easements is established by deed, not by record plat, in a multi-step process, described below:

Step 1: Verify if existing facilities are present; see Step 2. If there are no existing facilities, consult with the District Engineer. If it is determined the County can accept the abandonment of the easement, proceed to Step 3 to prepare the easement abandonment package.

Step 2: If the facilities are to be abandoned, a valid permit needs to be issued and the relocated facilities constructed and accepted prior to recording the final easement abandonment document. The other steps in Section 11.6 can proceed with the exception of the recordation of the release.

Step 3: Submit the easement release package to the first-floor permits counter, which will forward the package to the District Engineer to start the review process. The following information is required to process a release:

- A. Consultant's transmittal (completely filled out);
- B. Letter explaining why the easement should be release or abandoned;
- C. Plan showing the existing easement to be released;
- D. Copy of recorded easement that is to be released;
- E. As-built plan and letter from a DPIE inspector confirming construction completion and acceptance of relocated facilities, if required;
- F. Deeds, tax records, verification of current ownership; and
- G. Any supporting documents.

The District Engineer will review the release package. If there is no objection to the release and the package is complete and correct, the package will be sent to DPIE Rights-of-Way Unit for processing. If the package is incomplete or found to be insufficient, the package will be returned to the permittee or his or her designated representative for corrections.

Step 4: DPIE Right-of-Way Unit will review the easement release documents for sufficiency and accuracy. If the package is incomplete or found to be insufficient, the package will be returned to the permittee or his or her representative for corrections.

Step 5: DPIE Right-of-Way Unit will prepare a package to be forwarded to the County's Office of Law and to the Director of DPIE for review and approval.

Step 6: The release package will then be forwarded to the Administrative Review Committee (ARC) for approval and signature by an authorized County Official before being released.



Step 7: When the signed release is returned to the DPIE Right-of-Way Unit, a letter will be drafted to the permittee or his or her designated representative stating the release has been signed by the County. The original release will be sent with the letter for the permittee to record. It is the responsibility of the permittee or representative to record the release in the Land Records of Prince George's County. DPIE will notify all interested parties after the release is secured.

The process to vacate a public right-of-way is set forth in Subtitle 24 Subdivision Regulations. If the right-of-way was dedicated after 1908 by a Record Plat, it will require approval of a vacation petition by the Planning Board pursuant to Section 24-112 of the Subdivision Regulations. M-NCPPC will coordinate the vacation petition review on behalf of the applicant with all of the appropriate County agencies. The road closure process is described in detail in the Prince Georges County *DPW&T Specifications and Standards for Roadways and Bridges* Chapter 3, Section D, "Road Closure and Vacation of Right-of-Way" and the vacation petition process is described in Section 24-112 of the Subdivision Regulations.

### **11.1.8 Easements on Lands Owned by County, State, Federal Governments or Utility Companies**

Securing a right-of-way or easement on lands owned by the County or County agency, M-NCPPC, State or Federal Governments, and utility companies such as WSSC, Potomac Electric Power Company (PEPCO), Southern Maryland Electric Cooperative (SMECO), and Washington Gas, is often necessary in the development review process. This requires early and constant communication with the appropriate government agency or utility company. Guidance for each of the entities is presented below.

#### **11.1.8.1 Federal Facilities**

Prince George's County is home to many agencies of the Federal government, including major landowners such as USDA, the National Aeronautics and Space Administration, the U.S. Department of Interior, and numerous other agencies. The property could contain a single parcel of land with an office building or multiple parcels with varied public missions. The Federal government will not grant a right-of-way or an easement to transfer property to a local County. Instead, Federal agencies may only grant permission for a specific use. The individual agency must be contacted, as each will have its own criteria to follow.

#### **11.1.8.2 State Property**

The management of State property is divided between two basic entities, MSHA and all other State agencies. If the intention is to extend an outfall, pipe, or other drainage system into an MSHA right-of-way or construct a SWM device in a State right-of-way, an approval and permit by MSHA is required.

Conveyance of land from MSHA or discharging onto land owned by other State agencies will require coordination with the respective agencies to obtain their approval. Once approval is obtained, the Maryland Board of Public Works must

then approve land conveyances from the State of Maryland. The board includes the Governor, Comptroller, and State Treasurer.

#### **11.1.8.3 WSSC**

WSSC has an extensive linear system of pipelines that could be affected by crossings of storm drains or similar facilities. If a proposed storm drain or SWM system is planned to cross existing WSSC facilities, easements, or property the applicant must submit plans to WSSC and gain approval for proposed activities in WSSC easement or land. In addition, WSSC owns a number of facilities such as pump stations, wastewater and water treatment plants, maintenance depots, and other land necessary for the Commission's operations and maintenance. WSSC does not grant easements across its property; however, it may grant a "Right of Entry Permit." This applies to a crossing of an existing water/sewer easement outside a public right-of-way or crossing any land owned by WSSC. The Major Systems and Relocation Section should be contacted at (301) 206-9772 for submittal requirements.

#### **11.1.8.4 Maryland-National Capital Park and Planning Commission**

M-NCPPC DPR is one of the largest landowners in the County. In addition to land, DPR owns many park buildings, playing fields, and other facilities. For new subdivisions, the floodplain and stream valleys are sometimes conveyed to the M-NCPPC to meet adequacy requirements for mandatory dedication. This provides protection in the form of conservation.

Generally, M-NCPPC does not grant perpetual easements; instead, it most often requires a "Right of Entry Agreement." Any proposal to locate a permanent facility such as an SWM facility storm drain outfall, or any temporary impact on park property requires coordination with the DPR Park, Planning, and Development Division, Engineering Section. Additional information is available from officials at (301)-699-2525.

#### **11.1.8.5 Public Utilities**

The presence of public utility companies such as, but not limited to PEPCO, Baltimore Gas and Electric, Washington Gas Light Company, SMECO, Verizon, Comcast, etc., must be accounted for in any design. Generally, utility company facilities are located in a public utility easement, although some utilities may have additional easements or rights-of-way to accommodate their facilities. It is incumbent upon the applicant to contact the public utility and obtain its approval for disturbance, additional easement, or other requirements as directed by the utility company, and provide this information to the District Engineer prior to permit issuance.

#### **11.1.8.6 Board of Education**

If property owned by the Prince George's County Board of Education is to be affected, the request will require staff review, presentation to the School Board for approval, and finally a signature by the Chairperson of the Board.

The DPIE Right-of-Way Unit is the lead for the processing of easements and road rights-of-way that are not part of the Preliminary Plan of Subdivision process. All easements must be submitted to the DPIE first-floor permit processing counter, with "District Engineer" noted on the transmittal. Processing easements in any other way may delay the permit issuance for the project. The District Engineer will review the package and if deemed complete, will forward the package to the Realty Specialist in the DPIE Rights-of-Way Unit for review of correct ownership, adequacy of legal documentation, and easement document preparation. The County provides easement documents, with standard language. Standard easement language for various easement types is included in Appendix 11-5.

The easement submission requirements are listed below:

- A. One original Prince George's County Right-Of-Way Survey Transmittal and two copies (per grantor or for multiple grantors of the same property) (Appendix 11-6);
- B. Legal description on 8.5" x 11" paper, certified correct by a Maryland Registered Land Surveyor or Property Line Surveyor (original and two copies);
- C. Easement sketch or drawing should be on 8.5" x 11" paper and of the same scale as the approved storm drain plan, certified correct by a Maryland Registered Land Surveyor or Property Line Surveyor (original and two paper copies);
- D. Copy of current record plat;
- E. Copy of current deed of ownership; and
- F. Documentation to verify who can sign for the owner (e.g., Corporations, Limited Liability Companies, Limited Partnerships). This may include submittal of Corporate By-Laws, Articles of Incorporation, an Operating Agreement, a Partnership Agreement, or any other legally recognized document filed when the entity was established or any subsequent amendments.

## 11.2 Easement and Right-of-Way Submission Requirements

The DPIE Right-of-Way Unit is the lead for processing of easements and road rights-of-way not part of the Preliminary Plan of Subdivision process. All easements must be submitted to the

DPIE first-floor permit processing counter, with “District Engineer” noted on the transmittal. Processing easements in any other way may delay the permit issuance for the project. The District Engineer will review the package and if deemed complete, will forward the package to the Realty Specialist in the DPIE Rights-of-Way Unit for review of correct ownership, adequacy of legal documentation, and easement document preparation. The County provides easement documents with standard language. Standard easement language for various easement types is included in Appendix 11-5.

The easement submission requirements are listed below:

- A. One original Prince George’s County Right-Of-Way Survey Transmittal and two copies (per grantor or for multiple grantors of the same property) (Appendix 11-6);
- B. Legal description on 8.5" x 11" paper, certified correct by a Maryland Registered Land Surveyor or Property Line Surveyor (original and two copies) (Appendix 11);
- C. Easement sketch or drawing should be on 8.5" x 11" paper and of the same scale as the approved storm drain plan, certified correct by a Maryland Registered Land Surveyor or Property Line Surveyor (original and two paper copies);
- D. Copy of current record plat;
- E. Copy of current deed of ownership; and
- F. Documentation to verify who can sign for the owner (e.g., Corporations, Limited Liability Companies, Limited Partnerships). This may include submittal of Corporate By-Laws, Articles of Incorporation, an Operating Agreement, a Partnership Agreement, or any other legally recognized document filed when the entity was established or any subsequent amendments.

### **11.2.1 Dedication of Right-of-Way to the County**

Dedication of right-of-way is sometimes required to expand the public road right-of-way. If property is to be deeded to the County for purpose of a public right-of-way, not included as part of a final plat process, the right-of-way dedication document will be prepared by DPIE. It is preferable that a minor final plat be prepared for the dedication in accordance with the Subdivision Regulations. Dedication of right-of-way is sometimes required to expand the public road right-of-way.

All dedications must be submitted to the DPIE first-floor permit processing counter, with “District Engineer” noted on the transmittal. Processing dedications in any other way may delay the permit issuance for the project. The District Engineer will review the package and if deemed complete, will forward the package to the Realty Specialist in the DPIE Rights-of-Way Unit for review of correct ownership, adequacy of legal documentation, and dedication document preparation. The County provides dedication documents with standard language.

The applicant shall submit the following information to DPIE for review of a right-of-way dedication that is not part of the plat process:

- A. Consultant's transmittal.
- B. Copy of the approved Road Improvement Plan or similar type of plan.
- C. If the size of the paper for the sketch is too small for the dedication, it is permissible to reduce the plan scale of the sketch, provided that the design consultant submits a supplementary drawing at the same scale as the approved plan.
- D. All rights-of-way for the permit shall be submitted at the same time.
- E. One original Prince George's County Right-Of-Way Survey Transmittal and two copies (per grantor or for multiple grantors of the same property).
- F. Legal description on 8.5" x 11" paper, certified correct by a Maryland Registered Land Surveyor or Property Line Surveyor (original and two copies).
- G. Sketch or drawing should be on 8.5" x 11" paper and of the same scale as the approved plan, certified correct by a Maryland Registered Land Surveyor or Property Line Surveyor (original and two copies).
- H. Copy of current deed of ownership.
- I. Proof that real estate taxes have been paid for the current year. Failure to provide this information will stop the recording of the deed and hold up the release of the permit.
- J. Documentation to verify who can sign for the owner e.g., Corporations, Limited Liability Companies, Limited Partnerships. This may include submittal of Corporate By-Laws, Articles of Incorporation, an Operating Agreement, a Partnership Agreement or any other legally recognized document filed when the entity was established or any subsequent amendments.

### 11.2.2 Impacts to County Property

When projects require construction on Prince George's County property, the applicant shall submit an easement package, following the same procedures as any other easement.

- A. Consultant's transmittal.
- B. Copy of the Permit Plan.

- C. If the size of the paper for the sketch is too small for the easement, it is permissible to reduce the plan scale of the sketch and provide a supplementary drawing at the same scale as the approved plan.

See Section 11.1.7 steps 4 - 7 for processing an easement through the Administrative Review Committee process.

### 11.3 Document Processing Procedures

Once the package has been transmitted to the Realty Specialist, the following steps occur.

- A. Upon receipt in the DPIE Right-of-Way Unit, the document will be reviewed for sufficiency. If it is incomplete or if there are comments that require corrections, it will be returned to the consultant. Once the corrections have been made, the easement package will be resubmitted to the DPIE permits office, but it may be addressed directly to the Realty Specialist instead of the District Engineer. The Realty Specialist verifies the following aspects of the package:
- Accuracy of the metes and bounds description and sketch.
  - Grantor (owner) cited in the description matches with current deed on record at the time of easement processing.
  - Signatory name has the legal right to sign the easement document, as substantiated by an Operating Agreement and other legal documentation. See Section 11.3.5 F for additional information.
- B. When the easement document is prepared, it is sent to either the permittee or design consultant for the owner's signature to be obtained based on the instructions on the DPIE Right-of Way survey transmittal.
- C. The Right-of-Way Unit will send the easement documents for off-site easements to the property owner directly unless otherwise requested. Easement documents prepared for the signature of off-site property owners are picked up or sent to the permittee or designated representative. The applicant is responsible for collecting all the property documentation and for returning same to the Right-of-Way Unit for final processing and recordation.
- D. After landowner signature has been obtained, the document must be submitted back to the Realty Specialist through the First-Floor Permits Office for recordation. At this point, the Realty Specialist again verifies the property ownership to ensure that it has not changed. The owner/applicant should obtain the signatures quickly and avoid land transfers during this period of processing, to ensure that the document can be recorded in a timely manner.

- E. If the document is acceptable and there have been no changes, the document will be hand carried to Upper Marlboro for recordation in Land Records. A copy of the recorded document with a receipt attached will be brought back to the Right-of-Way Unit and the Permits Section and the District Engineers will be notified. The original document will be located in Upper Marlboro until the recording information (liber and folio) can be attached.
- F. **Only the County may record documents when the County is the Grantee.** If the document is recorded by another party, the County will not accept the recordation as valid.

#### 11.4 Fee Simple Deed (dedication) Processing Procedures

Once the package has been transmitted to the Realty Specialist,

- A. Upon receipt in the DPIE Right-of-Way Unit, the document will be reviewed for sufficiency. If it is incomplete or if there are comments that require correction, it will be returned to the design consultant. Once the corrections have been made, the easement package will be resubmitted to the DPIE permits office, but it may be addressed directly to the Realty Specialist instead of the District Engineer. The Realty Specialist verifies the following aspects of the package:
- Accuracy of the metes and bounds description and sketch.
  - Grantor (owner) cited in the description matches with current deed on record at the time of dedication processing.
  - Signatory name has the legal right to sign the dedication document, as substantiated by an Operating Agreement and other Legal Documentation if owner is an entity.
  - Property taxes have been paid.
- B. When the dedication document is prepared, it is sent to County's Office of Law for Review/ Approval and Signature.
- C. When the document is returned to the Right-of-Way Unit with the attorney's signature attached, the document is sent to either the applicant or design consultant, whichever is referenced on the Survey Transmittal, for the owner's signature to be obtained.
- D. The Right-of-Way Section will send the documents for off-site dedications to the property owner directly, unless otherwise requested. Dedication documents prepared for the signature of off-site property owners are picked up or sent to the applicant or designated representative. The developer is responsible for collecting all the property documentation and for returning the complete information to the Right-of-Way Section for final processing and recordation.

- E. After landowner signature has been obtained, the document must be submitted back to the Realty Specialist through the First Floor Permits Office for recordation. At this point, the Realty Specialist again verifies the property ownership to ensure that it has not changed, that the document has not been changed, and that property taxes have been paid. The owner/applicant should process signatures quickly and avoid land transfers during this period of processing, to ensure that the document can be recorded in a timely manner.
- F. If the document is acceptable and there have been no changes, the document will be hand carried to the WSSC in Laurel for signature and stamp. From there it is delivered to Upper Marlboro for approval and stamping by the Finance Department and the Property Assessment Department. There the document is recorded in Land Records. A copy of the recorded document with a receipt attached is then brought back to the Right-of-Way Unit. The Permits Section and the District Engineer are notified. The original document remains in Upper Marlboro until the recording information (liber and folio) can be attached.
- G. **Only the County may record documents when the County is the Grantee.** If the document is recorded by another party, the County will not accept the recordation as valid. The District Engineer will be notified by the Right-of-Way Unit that the easement has been executed and recorded.

### 11.5 Revision to Existing Easements

When submitting an easement/right-of-way revision, mark the revision box on the Prince George's County transmittal. Provide a brief explanation for the purpose of the revision. By following this procedure you will eliminate unnecessary delays in processing a revision. The following procedures must be followed:

- A. If any additional on-site easements/rights-of-way are required, the applicant must draft and sign a letter of agreement and submit it to DPIE.
- B. For on-site easements/rights-of-way, this letter must state that the applicant understands that as-builts will not be finalized and the bond will not be released until the revised easement(s) is/are recorded. (All easements are recorded in the Land Records of Prince George's County by DPIE personnel only.)
- C. For off-site easements or rights-of-way, the plan revision will not be signed until the easement or rights-of-way are recorded within the Land Records of Prince George's County, Maryland.

The revision package is to be sent to the DPIE Permit Processing Office with the District Engineer's name on the transmittal. If the easement or right-of-way is acceptable, they will be forwarded to the DPIE Rights-Of-Way Unit for processing.

All of the above will be reviewed by the Realty Specialist to ensure easements are secured before any releases are granted.



## 11.6 Declaration of Covenants

For private drainage facilities, easement dedication is not required. However, a Declaration of Covenants (commonly referred to as a Maintenance Agreement) shall be recorded by the permittee. The Declaration of Covenants is between the owner of the property and Prince George's County. The declaration allows the County to inspect the facilities and enforce maintenance. No changes to the covenant are allowed unless approved by the County Attorney. This agreement requires the landowner to assume all responsibilities to construct and perpetually maintain storm drain, ESD, and underground and surface management facilities. This document must be signed by the landowner, reviewed and signed by the DPIE District Engineer, and then recorded in Land Records by the property owner prior to the issuance of site development permits if the project is all private or prior to plan approval for a combination public/private project. See Appendix 11-7 for Declaration of Covenants

## 11.7 Quit Claim Deed

A quit claim deed (sometimes erroneously referred to as a "quick-claim" deed) is a legal instrument by which the owner of a piece of real property, called the grantor, transfers their interest to a recipient, called the grantee. The owner/grantor terminates ("quits") their right and claim to the property, thereby allowing claim to transfer to the recipient/grantee. Accordingly, the County will not accept a quit claim unless the County agrees to accept the property.

## 11.8 Permitting Requirements

A permit issued by the County shall not be issued until easements, rights-of-way, and/or declarations of covenants, have been recorded. This is in accordance with County Code Sec. 32-184(a)(2). The responsibility for preparing the submittal package and obtaining the owner's signatures in a timely fashion is the responsibility of the applicant. This requirement may only be waived by the Director of DPIE. The following types of documents must be recorded for work included in the permit limits:

- Storm drain, SWM, and floodplain easements must be recorded prior to issuance of conditional plan permits or site development permits, whichever occur first.
- Conservation easements must be recorded prior to issuance of site development permits.
- Access and grading easements (offsite) must be recorded prior to issuance of site development permits.
- Road right-of-way dedication must be recorded prior to issuance of site development permits.
- Declaration of Covenants must be recorded prior to issuance of site development permits.
- Surface drainage easements must be recorded prior to building permit issuance.

- Release of existing easements and rights-of-way must be recorded before issuance of a building permit to construct within those areas.

This Page Intentionally Left Blank

---

**Chapter 12 BOND PROCESSING AND BOND RELEASE****12.1 Introduction**

All proposed site/road permits for land development projects in Prince George's County that contain grading, public storm drain, or public SWM systems are required to be bonded prior to the issuance of a site development or street construction permit. **DO NOT ATTEMPT TO SUBMIT A BOND PACKAGE THAT IS NOT PREPARED BY DPIE. IT WILL BE REJECTED AND WILL ONLY DELAY THE PROCESSING OF THE PERMIT.**

Types of securities acceptable to the County include: irrevocable letter of credit, cash, check (funds to be held in non-interest escrow), and surety. Examples of the approved Prince George's County forms are found in Appendix 12-1. For more information on bonding, see County Code Sec. 23-116.

**12.2 Construction Cost Estimates**

In order to determine the bond amount for construction of grading and public systems, the developer or representative shall submit the construction cost estimates (Appendix 12-2), along with a copy of the technical plans and a transmittal requesting cost estimate approval to DPIE. The review of the cost estimate occurs at the time of application for a permit. Cost estimates must be based upon the County approved unit costs included in the Prince George's County Department of Public Works and Transportation *Specifications and Standards for Roadways and Bridges*.

**12.3 Bonding General Instructions**

- A. Performance bonds. Surety (insurance company bonds), letter of credit, cash or assignment of account. All performance bonds will be 100% of the total project construction cost plus 25% contingency.
- B. Labor and materials bonds are only required when the amount of the performance bond is greater than \$25,000 or if a surety is posted for the performance bond. The only exception is for on-site grading and Storm Drain/SWM systems outside the public right-of-way, where no L&M is required. The L&M may be a surety (insurance company bond), letter of credit, or cash. All labor and material bonds will be 40% of the performance bond amount.
- C. All bonds will be accompanied by three each of the proper forms, signed with original signatures and original notary public stamp per form.
- D. The bond number is considered the same number as the permit case number (i.e., xxxxx-YEAR-PB for a performance bond or xxxxx-YEAR-LM for a labor and materials bond).
- E. See instructions for authorized banks and how to fill out forms.

- F. All bonds and completed forms are to be returned to DPIE to be processed. No permit will be issued until the bond is approved.
- G. All bonds and completed forms will be transmitted by DPIE to the County Office of Law, except cash or check bonds, which will be transmitted by DPIE to the Office of Finance for review and approval. Applicants may use the Office of Law checklist to complete the package (Appendix 12-3).

**12.4 Municipal Bond**

- A. Municipalities may bond municipal projects within their jurisdiction, providing they submit evidence of such a bond to DPIE.
- B. The City of Greenbelt is responsible for monitoring bonds for public systems that are within its municipality boundary.

**12.5 DPIE Bonding**

Bonding of projects with DPIE shall be processed under the criteria set forth below.

- A. Bonds shall include all storm drain, SWM, water quality structures, and outfalls within DPIE’s public road rights-of-way or easements. (Note: Bonds also includes everything in the public right-of-way that is proposed by the permit, including paving, sidewalk, street trees, and grading). If the outfall extends beyond the public road rights-of-way, the bonding limits shall extend to the next logical structure. If the onsite storm drain system is private, a single-storm drain structure and connecting pipe located outside the road rights-of-way at either end of the system will also be bonded with DPIE.
- B. Bonds shall include public storm drain, SWM, and grading outside the public right-of-way (but only a performance bond is required for this portion).
- C. Bonds shall include the construction cost of all public storm drain structures and outfalls for single family attached units that are fee simple lots located outside of incorporated municipalities, including all water quality structures except ponds.
- D. Bonds shall include all detention or retention SWM facilities using the road rights-of-way as an embankment (acting as a dam); DPIE will bond from 1 foot below street sub-grade elevations and up.
- E. Bonds shall include all public storm drain systems within the limits of Prince George’s County incorporated cities and municipalities, except the City of Bowie and City of Greenbelt. The following is a list of cities and municipalities:

Bladensburg	Glenarden
Berwyn Heights	Hyattsville
Brentwood	Laurel

---

Capitol Heights	Landover Hills
Cheverly	Morningside
Cottage City	Mount Rainier
Colmar Manor	North Brentwood
College Park	New Carrollton
District Heights	Riverdale Park
Edmonston	Seat Pleasant
Eagle Harbor	Upper Marlboro
Fairmount Heights	University Park
Forest Heights	

All storm drain systems within the City of Greenbelt will be bonded with the City of Greenbelt.

**NOTE: Whoever holds the bond will inspect the construction of the project.**

- F. To determine which storm drain piping system will be bonded with DPIE, the storm drain profiles must have “Lead Arrows” to indicate the limits of public systems. In addition, the structure and pipe schedule will also indicate whether the pipe or structure is public, private, or other.

## 12.6 Requirements for Bond Submittal

Once the bonding company has completed the appropriate forms, the bonds shall be submitted to the Site/Road Permit Processing Unit of DPIE for processing. The bonds must be the original bond forms provided to the applicant by the DPIE Site/Road Permit Processing Unit. The bond forms cannot be altered, or they will be rejected. The securities can be any of the following: surety (by insurance agency), letter of credit (by bank), or cash. Cash or check is sent directly from DPIE to the Office of Finance and put into a non-interest bearing escrow account. The following are the steps to process and approve the bond.

- A. The applicant shall submit to DPIE, three original Bond Agreements with Prince George’s County, one original and two copies of the security. This is known as the bond package.
- B. DPIE will review the agreement and security package for project name, number, amount, beneficiary owner, signatures, and correct security format. The bond package will be returned to the applicant to correct any deficiencies.
- C. DPIE will then forward the bond package to the Office of Law for review. The Office of Law will not accept any bond packages that have not been processed through DPIE.

- D. The Office of Law reviews the bond package and will approve or disapprove with any necessary comments. The package will then be returned to DPIE.
- E. If the bond cannot be approved, DPIE will return the bond package to the applicant with the Office of Law deficiencies noted for correction. Once corrections or additions have been made, the applicant will resubmit the package to DPIE and steps B through D will be repeated.
- F. If the bond package is approved, the DPIE Site/Road Permit Processing Unit will send an approved copy to the permittee and maintain a copy for County files.

**12.7 Partial Bond Release**

In some cases, a performance bond may be reduced if sufficient construction has been completed for the road work. See County Code Sec. 23-116 (h) for more information.

(h) *Refund Agreements for Phases of Work Completed.*

- (1) *Cash, letters of credit, certificates of guarantee, and other instruments, not to include surety bonds, posted by the permittee and accepted by the County may be refunded upon request of the permittee on a prorated basis, depending on the value of the completed and approved work, as follows:*

% OF WORK COMPLETED	% REFUND AMOUNT
50	25
80	75
Acceptance	100

- (2) *Reduction in the Amount of a Surety Bond Posted for Urban Road Classifications. When all work is completed on a permit except the placement of sod and the planting of trees, the permittee may request a reduction in the surety bond amount to fifty percent (50%) of the original amount or Twenty-five Thousand Dollars (\$25,000.00), whichever is greater, provided that all of the storm water drainage systems have been constructed by the permittee and approved by the Director.*
- (3) *There shall be no reduction in the amount of a surety bond posted for rural road classifications.*
- (4) *Release of Claims. In no event shall any labor and materialman's bond be reduced or released until all claims by laborers and material suppliers have been paid, and a release of claims covering the work completed has been filed with the Department.*

**12.8 Bond Release**

Bonds cannot be released until the proper Acceptance Memo (See Appendix 12 for an example) notification has been sent by the DPIE Inspections Division to the DPIE Site/Road Permit Processing Unit. See Section 3.7 for information on permit release. This acceptance memo is

based on the project's final inspection and certification. If other permits are being covered under a bond, they must also be released prior or concurrently with the final bond release. See Chapter 14 for instructions on how to close out a permit with the inspector.

Once an Acceptance Memo (official notification from the DPIE Inspection Division that a permittee's work has been completed and is acceptable to the County) (Appendix 12-4) is received at the Site/Road Permit Processing Unit, the Unit will follow the procedures below.

- A. The performance bond shall be released (separately) immediately upon receipt of the Acceptance Memo and after posting of a cash bond for street trees, if required. The release of the performance bond will not be linked to the release of the labor and materials bond, which can occur at a later date.
- B. The labor and materials bond can be released once a certified list of all persons contracted to perform work and a certified release of lien from each person is provided by permittee, prior to release.
- C. The Unit will post a cash bond for street trees, if requested by the inspector.

When the required release of liens and/or cash bond for street trees is received, the Site/Road Permit Processing Unit will release the labor and materials bond and close out the permit case number except for the street tree cash bond, which will stay active on the closed permit.

A street tree cash bond is released after 1 year of successful growth of the trees, and inspection of such by the field inspector at the request of the permittee.

In cases where no release of liens or a street tree cash bond is required, the Site/Road Permit Processing Unit will simply prepare the release letter and close out the permit case.

- The original letters of credit are mailed to the bank.
- Cash bonds will be released when the Acceptance Memo issued by the Site/Road Inspector has been received by the DPIE Site/Road Permit Processing Unit. Then, a payment request will be forwarded to the Office of Finance, which processes the refund request and sends a check to the permittee/payer.

The DPIE Site/Road Permit Processing Unit will send a notification of a bond release letter or letter of credit where applicable to the appropriate institution and to the permittee who has posted the bond. It is the responsibility of the permittee to contact the bonding company to close out their bond. The DPIE Site/Road Permit Processing Unit can be contacted by telephone at (301) 883-5915.

### **12.9 Change of Permit Application Responsibility**

It is possible the permittee may want to change the responsibility for completing the permit application requirements for issuance of a permit or to correct a mistake in the permittee's



name. The following procedure will be used if the permit application was received but no permit issued.

- A. If the permit is for work in a public right-of-way only, the permit number may be transferred with a notarized letter from the original permittee stating that a new permittee will take over the responsibility of processing the permit.
- B. If the work involves grading on areas outside of the public right-of-way, then only companies that are related to each other may have the permit number transferred to the new entity by using a notarized letter. The information will be sent to the Office of Law for review.
- C. If the permit for grading on a lot will be issued to an unrelated firm, then a new permit application will be required and the original permit will be abandoned.
- D. The permit fee is \$250 for the transference of responsibility.
- E. Bonds shall be posted with the correct corporate entity. If bonds were previously posted with the first permit applicant, they will be released after new bonds have been posted and accepted with the new permit applicant.

#### 12.10 Modify or Change Permittee

When it becomes necessary to change the permittee for an issued permit, a different process will be followed, as bonds will need to be replaced in addition to the name change. There are several scenarios that are outlined below.

- A. Permit issued and still valid but no work started.
  - 1. Apply for a new permit with the new applicant's name on the design plan.
  - 2. Submit permit fee based on construction estimate.
  - 3. The review fee will be \$250 to process the name change.
  - 4. Post bonds based on previously approved construction estimate on bond forms provided by the County.
  - 5. When the new permit is issued, the old permit will be closed out and its associated bonds released to the previous permittee, following the procedures described in Section 12.8.
- B. Permit issued, construction started, and the permit is active.
  - 1. Apply for permit with new applicant's name on the design plan.

2. The permit fee is \$250 for the change to the permittee name.
  3. Post bonds based on approved construction estimate.
  4. When the new permit is issued, the previous permit will be closed out and its associated bonds released to the previous permittee as described in Section 12.8.
- C. Permit issued, construction started, and the permit is inactive.
1. Apply for permit with new applicant's name on the design plan and the design plan is updated to reflect the remaining work to be completed. The review fee will be based on the 10% of the estimated construction cost to complete the project.
  2. Post bonds based on approved construction estimate.
  3. When the new permit is issued, the previous permit will be closed out and its associated bonds released to the previous permittee as described in Section 12.8.

This Page Intentionally Left Blank

---

## Chapter 13 QUALITY ASSURANCE

### 13.1 Objective

To assure the quality of storm drain pipe, structures, water quality structures, SWM structures, and other drainage components installed in the County.

### 13.2 Suppliers

The County will use the MSHA\ approved suppliers' list to define acceptable manufacturers supplying pre-cast storm drain structures, water quality structures, pipes, and SWM material for private or public projects.

- MSHA approved suppliers for materials

#### Qualified Producers & Products

- MSHA approved traffic safety manufacturers

#### Qualified Products List

An updated list is also available from the DPIE. A note, reflecting this requirement, shall be added to the design plan application. The applicant shall comply accordingly with the list of approved suppliers, which is periodically updated by MSHA.

### 13.3 Approved Material

All reinforced concrete pipes should be manufactured according to ASTM standard specifications; approved pre-cast structures are listed in the Prince George's County Department of Environment *Standard Details for Stormwater Management Construction, January 2001*.

Any modifications, special designs or production of non-standard materials to either pipe or structures shall require the submittal of a shop drawing to DPIE for review and approval. Non-standard materials include RCP greater than 72 inches in diameter, pre-cast box culverts, vaults, non-standard storm drain inlets or manholes, etc. Shop drawings shall be sealed and signed by a Professional Engineer licensed in the State of Maryland.

### 13.4 Materials Release and Certifications

All standard storm drain pipe may be delivered to project sites without prior approval or official release. Non-standard or "special" pre-cast structures shall be approved by DPIE prior to production. Suppliers should attach a materials certification letter with the delivered products for all public storm drain pipes/structures to DPIE in the following format:

- A. Contractor's name and address.
- B. Project name and DPIE Permit Case Number.
- C. Manufacturer's product certification.

D. Type and quality of product as it appears on the approved storm drain/SWM plan.

The absence of the materials certification letter shall result in failure to approve the as-built plan and thus, delay any in bond release.

### 13.5 Shop Drawing Submittal and Processing Requirements

Shop drawings are required for any pre-cast riser structure, box culverts, end wall with pipe outfalls larger than 72 inches, or for any structure larger than shown on County or MSHA standard details. The shop drawings shall be reviewed by the design consultant, noting any deviations from the approved dimensions before transmittal to DPIE for approval by the District Engineer. It is the responsibility of the permittee to verify that the shop drawing dimensions are similar to the approved design before submitting to the County. The following information shall be provided to the County for review and approval of the shop drawing.

- A. Consultant's letter of transmittal with permit number included.
- B. A copy of the approved plan detail sheet with the riser structure sections.
- C. Completed shop drawing form signed by permittee. (Appendix 13-1)
- D. Shop drawings and structural computations signed and sealed by a Professional Engineer from the manufacturer registered in the State of Maryland
- E. Flotation computations, if the structure deviates from the approved design dimensions, also signed by a Professional Engineer.
- F. Copy of approved permit plan.

After review and acceptance by DPIE of the shop drawing, the District Engineer will stamp the shop drawing approved and distribute copies as follows.

- two red line copies to the permittee, who is responsible for forwarding a copy to the manufacturer.
- one copy to the inspector.
- one copy to the permit file.

Upon delivery of the structure to the site, it is the permittee's responsibility to provide a copy of the approved shop drawing to the DPIE inspector and/or private inspector before the structure is unloaded. The permittee is required to contact the County inspector so he or she is present when delivery is made. The inspector shall inspect the pipes and structures for:

- Green concrete (not fully cured)
- Cracks, bell damage, exposed steel

- Equipment type designation for off-loading, lift hooks.
- Associated appurtenances/materials such as gaskets, parging supplies, lift hole plugs
- Certification documents

### 13.6 Site Inspections

Inspection of standard storm drain materials such as pipe or pre-cast structures will take place at the project site and prior to installation. The decision to accept or reject any product will be made by the DPIE County Inspector, third party inspector, or District Engineer. Rejection will be based on evident damage or fabrication that does not comply with County standards, permit drawing details, or approved shop drawings. The manufacturer will stamp, stencil, or paint each section of pipe or pre-cast structure designating its classification or structure number. For additional information on required inspections, see Chapter 14.

### 13.7 Site Storage and Stockpile

Proper pipe storage and structure storage are necessary to avoid damage. Locations of stockpile and storage of materials must be protected and secured, with erosion and sediment controls in place as needed, or per plan. Stacking of pipes shall be per manufacturers' guidelines and secured properly to prevent injury. Stockpile and storage locations must comply with the approved Final Grading, Erosion and Sediment Control Plans.

### 13.8 Plant Inspections

County representatives have the right to conduct random inspections at any approved manufacturing plant without prior notice. The County shall have the right to supervise the manufacturing process if deemed necessary or appropriate.

### 13.9 New SWM Practices Technology / Innovative Practices:

The County realizes and encourages that new and innovative approaches/practices to SWM are being developed on a continuous basis to be more cost-effective and achieve enhanced pollutant removal efficiencies. These practices can be used for redevelopment, infill development, pretreatment, and retrofit projects provided that they are reviewed and accepted by the County. In order to ensure that the innovative practices will achieve watershed restoration goals and meet storm water requirements for both MS4 Permit and Phase II Watershed Implementation Plan mandates, final acceptance of the practices are subject to the following procedural guidelines:

- The use of the practices (BMPs) must be documented in the County's TMDL implementation plan. Documentation must include all relevant scientific data related to the expected pollutant reduction efficiencies of the innovative practices and describe life-cycle maintenance requirements and costs.

- The proposed practices shall provide independently verified assessment data or propose a monitoring plan to evaluate the effectiveness of the practice.
- The County will submit all monitoring data to MDE for evaluation, and MDE will approve the appropriate credit toward meeting pollutant reduction targets under established TMDLs.
- The County shall submit the practice to the Bay Program's Urban Stormwater Workgroup for consideration as an EPA recognized storm water BMP.

---

## Chapter 14 CONSTRUCTION INSPECTION AND ENFORCEMENT

### 14.1 Purpose

This chapter establishes inspection and enforcement guidelines to be followed for construction of SWM, storm drain, and ESD measures. Section 14.13 was primarily developed based on information from the updated (MDE) *Maryland Design Manual* to add Chapter 5 and supplemented by requirements of Prince George's County DPIE. Notwithstanding what is discussed or referenced below, the Design Manual only provides guidance; the County Code shall be the final authority on any requirement.

### 14.2 Scope

The guidelines are to be applied uniformly for inspection of private and public storm drain, storm water management facilities, and ESD devices and water quality measures.

### 14.3 Authority and Responsibilities

#### 14.3.1 SWM DPIE Site/Road Inspectors

The Director is authorized by the Prince George's County Water Quality Resources and Grading Code to inspect and enforce the requirements of County Code Sections 32-186, 32-190 – 32-192, and 32-199 as follows:

- A. Authorized to conduct inspections and file reports for periodic inspections as necessary during construction of storm water systems to assure compliance with the approved plans and permits (County Code Sec. 32-190[b] and 32-191[a]).
- B. Authorized to furnish the permittee or agent the results of the inspection in a timely manner after the completion of each required inspection. (See Appendix 14-1 for sample inspection report) (County Code Sec. 32-190[d]).
- C. Authorized to issue a Correction Notice to the permittee when any portion of the work does not comply with the approved plans and/or permits (County Code Sec. 32-186).
- D. Authorized to issue a Notice of Violation in accordance with these guidelines as the result of unsatisfactory work or progress or noncompliance with approved plans or permits (County Code Sec. 32-191[b]1).
- E. Authorized to issue a Stop Work Order as the result of unsafe conditions, working without a permit, unsatisfactory work, progress, or other non-compliance (County Code Sec. 32-191[b]2).
- F. Authorized to issue a Civil Citation because of unsafe conditions, non-compliance with a Stop Work Order, unsatisfactory work, progress or other non-compliance (County Code Sec. 32-191[b]4).



- G. Authorized to perform a final inspection upon the completion of any storm drain, SWM, or water quality system. This is to determine if the completed work is constructed in accordance with the approved storm water design plan, approved as-built plan, and certified by the permittee's registered design consultants. All facilities must be certified by the appropriate Registered Engineer or Surveyor, and/or Landscape Architect. See Chapter 15 for additional information on the submittal of as-built requirements procedures (County Code Sections 32-191[d] and 32-192[a]).

### 14.3.2 Coordination among County and Other Inspectors

There is cooperation and communication among DPIE Site/Road Inspectors, Municipality Inspectors, and other inspection officials who perform storm drain, SWM, ESD, paving, TCP-2, and other horizontal inspections to ensure compliance of appropriate design plans and applicable County Codes. This process does not include building inspectors. The DPIE Site/Road Inspector serves as the lead inspector and presents the results of all other inspectors to the permittee.

### 14.3.3 Inspection Responsibilities

#### A. Construction Inspection

1. DPIE is responsible for providing inspections on all public and private SWM and water quality systems, as well as all public storm drain systems during installation and at completion. The permittee must also be present during the time of construction to provide certifications required by DPIE for storm drain, SWM, and ESD devices per County Code Sec. 32-191(a). A flowchart outlining the steps for construction inspection may be found in Appendix 14.
2. The permittee is responsible for contracting with a geotechnical engineer for soil and materials testing, concrete strength, soil compaction, and construction observation for the storm drain, SWM, and ESD devices. The test results shall include a certification to accompany the as-built drawings. The certification shall include a statement that the construction was "In accordance with the County approved plans and specifications."

#### B. Materials Testing

1. During the construction of all private projects including but not limited to SWM facilities and water quality facilities, the permittee is responsible for contracting with an independent materials testing laboratory.
2. Materials testing shall be performed in accordance with testing procedures as outlined in DPW&T *Specifications and Standards for Roadways and Bridges* "Technical Specifications." The County has adopted MSHA *Standards and Specifications for Construction and Materials*, except as

noted in Section II, "Technical Specifications." The permittee shall adhere to all rules and regulations set forth by DPIE with respect to quality assurance and quality control.

3. In the case of a publicly funded project, testing may be performed at the DPW&T material testing laboratory. Testing shall include, but is not limited to, soils, compaction, and concrete strength.
4. The permittee is required to supply the DPIE Site/Road Inspector with a list of materials used and laboratory test results. This includes actual test results whether performed in the field or the laboratory. A copy in an electronic format acceptable to the County shall be sent to the DPIE Site/Road Inspector, referencing the permit case number.

C. Exceptions

1. Inspections in the City of Greenbelt are as follows:

DPIE will perform a final inspection only on the public storm drain systems. All SWM and ESD systems will be inspected by the City of Greenbelt throughout the construction phase.

2. Inspections in the City of Bowie are as follows:

SWM and ESD systems, sediment control, public storm drains, and paving are inspected by the City of Bowie and are not inspected by the County. The County is only responsible for inspecting buildings and grading for compliance with the County's building and grading ordinances.

3. Inspections in the City of Laurel are as follows:

Stormwater management facilities, ESD systems, and public storm drains in the City of Laurel are inspected by Prince George's County. The inspection of buildings, paving, curb and gutter, street trees, street lights, grading, forest conservation requirements, and sediment controls are inspected by the City of Laurel.

4. Final Acceptance for Municipalities

When construction is complete, the DPIE Site/Road Inspector shall perform a final inspection and, if required, supply the permittee with a Correction Order (punch list). If the appropriate municipality wishes to be represented during the final inspection, they shall coordinate final inspection with the DPIE representatives. At acceptance, the DPIE Site/Road Inspector shall complete the final inspection report and forward to the DPIE Site/Road Permit Processing Section.

---

[List of Municipalities Inspections](#)

#### 14.3.4 Ponds Approved by Prince George's Soil Conservation District

PGSCD is responsible, through Maryland State Law, to review small pond embankments that meet MD-378 criteria. PGSCD is responsible for final acceptance of the Dam Safety As-Built Plan. A Registered Professional Engineer stating the facility was constructed in accordance with the approved design plans and specifications, including MD-378, shall certify the Dam Safety As-Built Plans. Dam Safety As-Built Plans must be submitted to the DPIE Site/Road Plan Review Division 30 days after initial construction of the pond. The plans must be processed through DPIE for approval, prior to PGSCD approval. PGSCD has authority for approving dam safety and embankment construction. PGSCD reviews and approves the plan after County approval, in accordance with the MOU updated July 2013, as noted in Appendix IX of the *Soil Erosion and Sediment Control-Pond Safety Reference Manual (PGSCD Reference Manual)*. Upon completion of final pond construction, with a previously approved Dam Safety As-Built Plan, a Final SWM As-Built Plan will be submitted to DPIE for approval. If no Dam Safety As-Built Plan was prepared, PGSCD will review the Final SWM As-Built Plan.

#### 14.3.5 Field Inspection Report

##### 14.3.5.1 Purpose

The purpose of the Field Inspection Report (FIR) is to notify the permittee of construction compliance status, deficiencies noted by the inspector, to direct repairs and corrections, and to ensure compliance with permits and approved plans.

##### 14.3.5.2 Scope and Applicability

FIRs are issued when each inspection occurs. The permittee may be directed to make changes to the work to comply with County Code or the approved permit drawings. The notice will set forth the nature of the corrections required and the time allotted to make the necessary corrections. FIRs may also be issued in cases such as:

- A. **Failure to comply with the design plan:** Incorrect measurements, using improper materials, or failing to follow proper procedures can prompt the issuance of an FIR. The FIRs will be issued in writing, which could result in immediate request for compliance. FIRs may dictate a date when the permittee must bring the site into compliance with the permit and approved plans.
- B. **Failure to provide certification for storm water structures:** The DPIE Inspections Division will issue an FIR to the permittee, requesting certifications and/or as-built plans when they are missing. A compliance date for submitting the required information will be supplied.

### 14.3.6 Notice of Violation and Stop Work Order

#### 14.3.6.1 Purpose

The purpose of issuing notices of violation and stop work orders is to gain compliance with corrections orders issued and/or the County Code Sections 28-261, 32-118, 32-190 – 32-191, and 32-199.

#### 14.3.6.2 Scope and Applicability

The DPIE Site/Road Inspectors will issue a notice of violation to a permittee/owner and/or the contractor, developer, or agent upon non-compliance of the County Code or Ordinance. In most cases, a FIR is used for the routine inspection first offense. Subsequent noncompliance with County Code or failure to complete the items on the FIR within a specified period will result in a violation. Notices of Violation (County Code Sec. 32-191[b][1]) or Stop Work Orders (County Code Sections 32-118 and 32-191[b][2]) may be issued in such cases as:

- A. **Failure to notify the Department before beginning any work to implement the storm water design (including not requesting a pre-construction meeting):** Any work that has been placed without a required inspection approval shall be certified in writing by a Registered Professional Engineer before the next phase of construction begins. DPIE reserves the right to require investigative materials testing of all un-inspected facilities, at the sole expense of the permittee. Any deficiencies to be corrected for work already started shall be listed and given a compliance date. The permittee shall be notified to call for future inspections as required, as well as any additional inspections required by the inspector.
- B. **Unlawful Continuance:** County Code Sec. 32-119. states, *“Any person, firm, association, partnership, or corporation, or combination thereof, who shall continue work in violation of the provisions of a “Stop Work Order,” or shall remove or cause to be removed a “Stop Work Order” sign still in effect and operation, shall be guilty of a misdemeanor, punishable by a fine of not more than One thousand Dollars (\$1,000.00) per day that the unlawful work continues, or imprisonment for six (6) months, or both.*
- C. **Working without a grading, building, or site development permit:** Issue a Stop Work Order directing the owner to obtain a permit. The violation would state that failure to comply may result in the suspension or revocation of any remaining permits issued for the site and/or civil citations being issued.
- D. **Failure to have sediment controls in place or improper sediment controls on storm water systems:** If excavation has been completed and

no sediment devices are in place to protect the storm water system and to prevent sediment from leaving areas of storm water system installation (i.e., storm drain installation), a violation will be issued with a directive to install or correct the sediment devices immediately or face a Stop Work Order for the entire site at the end of the day.

- D. **Failure to have work inspected and approved before continuing work:** If a County inspection is required, approval must be obtained before proceeding. Failure to obtain approval by the County may result in a certification in writing by a Registered Professional Engineer that the work was completed in accordance with the plans and specifications. DPIE reserves the right to require investigative or materials testing on all un-inspected facilities at the sole expense of the permittee.
- F. **Construction not in accordance with approved plans:** If work is not corrected as required by a previously issued FIR, a Notice of Violation to the permittee and/or the agent will be issued, directing immediate repairs to the noncompliant work. A Stop Work Order may be issued until all work is brought into compliance. If work has not been completed by the compliance date, a violation may be issued stating that a Stop Work Order may be issued, and that the permit(s) for this site may be suspended or revoked and bond recalled if the work is not completed by a new compliance date (County Code Sec. 32-186) .
- G. **Failure to provide certification for completed storm water structures:** If an engineer's certification and/or as-built plans are not received by the 30-day completion date, as required by a previously issued FIR, a notice of violation will be sent to the permittee, requesting certification and/or as-built plans.
- H. **Failure to call for a final inspection:** If the contractor fails to call for final inspection, the DPIE inspector may issue a notice of violation. The notice of violation will then list any deficiencies to be corrected, dictate a compliance date, and require submittal of a letter of certification and/or as-built plans (if required). The permittee shall request a re-inspection, after completing the corrections, so that another final inspection can be performed.

### 14.3.7 Civil Citations

#### 14.3.7.1 Scope and Applicability

The Director may authorize the issuance of a civil citation (County Code Sec. 32-191(b) (4)) by the DPIE Site/Road Inspector in the following situations:

- A. When an FIR notice of violation and/or Stop Work Order has not been complied with or there has not been substantial progress in complying with the violation and/or Stop Work Order.
- B. On abandoned sites where no work has been ongoing and continued noncompliance with a notice of violation may result in the issuance of repeat citations.
- C. When a Stop Work Order is in effect and work continues in defiance of the order.
- D. When repeated recurring violations of the same subtitle of the Water Quality Resources and Grading Code at the same location; or a violation of the same subtitle of the Water Quality Resources and Grading Code at a different location occurs by the same responsible party. Each day that a violation remains uncorrected constitutes a separate violation of applicable code or ordinance.
- E. Citations shall be hand delivered, when possible, to the permittee. When it is not possible, the citation will be sent by certified mail, return receipt requested. The permittee, owner, agents, lessees, builders, contractors, corporations or partnerships, etc., listed on a permit application or in the tax records may be cited under this provision of County Code Sec. 28-261 (Civil Monetary Fines or Penalties) and County Code Sec. 32-199.

#### 14.4 Complaints

A complaint as a result of clearing, grading, floodplain encroachment, storm drain, SWM, or ESD construction shall be reported to the County at (301) 883-0311. The specific complaint will be referred to the appropriate DPIE Site/Road Inspector.

#### 14.5 Project Default

The Permittee must complete all work within the specified time of the permit or file for an appropriate extension. Within 30 days of the permit's expiration, if no extension has been applied for, the Department will inspect the project to determine if:

- A. Work has been completed and the permit may be finalized;
- B. Only minor work remains and bonds should not be called; or
- C. Significant work remains, necessitating the calling of bonds.

If the work is completed, the acceptance and bond release procedures outlined in Chapter 12 may be initiated. For projects requiring only minor work for completion, the permittee will be advised of outstanding work, and a timeframe for required completion will be specified. The permittee may also be required to file for an extension at this time. If, however, a significant

portion of the project remains uncompleted, the permittee will be notified by the DPIE Site/Road Permits Unit to file for an extension to complete the work. If the permittee is unresponsive 30 days after the permit expiration date, the Director will declare the permit in default and move to call the bonds posted for the permit. (County Code Sec. 23-116[j][2])

Once a permit is in default, the Department will immediately notify the bonding institution(s) to undertake and complete the work in accordance with the permit. If the bonding institution or agent fails to commit to undertake completion of the work within 30 days of notice by the Department, the Director will move to collect all performance bonds posted for the work. The bonding institution or agent will have 30 days to issue payment to the County. Institutions that do not provide bond funding to complete the construction work risk being barred from issuing bonds for roadwork within the County for a period of 5 years (County Code Sec. 23-116[j][7]).

The Department will move immediately to collect the bond and carry out the work. The Department will use a portion or all of the proceeds from the bonds. Any excess amount will be returned to the payer after all work has been finished and all costs have been settled.

#### **14.6 Suspension/Revocation of Permit**

The Director may suspend or revoke any permit after written notice (County Code Sec. 32-186) for any of the following reasons:

- (a) Any violation(s) of the conditions of the approved final storm water management plan, including the provisions of the Conservation Plan and Conservation Agreement, where applicable;*
- (b) Construction not in accordance with the approved final storm water management plans or specifications;*
- (c) Noncompliance with correction notice(s) or stop work order(s) issued for the construction of any storm water management practice;*
- (d) An immediate danger exists in a downstream area as determined by the Department; or*
- (e) Permits found to be issued in error when the original approval did not conform to the provisions of this Division or the approval was based on inaccurate information provided by the permittee.*

A. .

Prior to revocation of a permit, the permittee will be notified in writing. The permittee will have 14 days to request an administrative appeal. Once requested, sufficient notice of the appeal hearing will be given to both the permittee and the public. After the appeal hearing, the Director will render a decision within 10 calendar days. If the ruling is for revocation, the posted bonds will be forfeited to the County.

## 14.7 General Inspection Requirements during Construction

### 14.7.1 Guidelines

The DPIE Site/Road Inspector will conduct inspections at the request of the permittee or the permittee's agent and at specified stages of construction for storm drain, SWM, or ESD devices. The inspector may also make unscheduled inspections to assure compliance with the Water Quality Resources and Grading Code requirements.

The *Prince George's County SWM Design Manual* Technical Specifications, County issued Bulletins or Field Notes, MD-378 Pond Specifications, MDE Specifications, MSHA Standards and Specifications, *PGSCD Reference Manual*, *2011 Maryland Standards and Specifications for Soil Erosion and Sediment Control*, and related references contain the primary guidelines, requirements, and regulations that the DPIE Site/Road Inspectors utilize to confirm compliance.

### 14.7.2 Field Changes

The Director may authorize the DPIE Site/Road Inspectors to accept minor field changes proposed by the permittee. A specific list of acceptable field changes will be reviewed periodically and updated for the inspector's use. A listing of minor/major changes specific to SWM facilities approved by PGSCD is provided on page VII-21 of the *PGSCD Reference Manual*. Any changes to grading, storm drain, paving, etc. on the permit drawings may require a red-line revision approved by the District Engineer or the permit drawings will require a formal revision. This will need to be coordinated with the District Engineer.

### 14.7.3 Required Stormwater Management Procedures and Inspections

County Code Sections 32-190 to 32-192 stipulate certain inspection requirements during the construction of SWM/water quality facilities. This will require issuance of inspection reports and gathering of certifications from the design consultants involved in construction. As-built plans are another requirement for final permit release (County Code Sec. 32-191[d]) and are discussed in more detail in Chapter 15. The following outlines procedures for inspections and certifications for storm drain, SWM, and water quality facilities.

A copy of the Notice of Required Stormwater Management Procedures and Inspections will be provided during the project's initial preconstruction meeting with a DPIE Site/Road Inspector. Additional information will also be provided at that time.

The owners of SWM facilities not exempt from small pond approval requirements outlined in the *PGSCD Reference Manual* are expected to comply with the conditions of the Small Pond Approval Form. A copy of the form was signed by the owner of the property and may be found on the approved design plans. The Small Pond Approval Form must be signed by PGSCD prior to its approval of the plan.



#### 14.7.4 Final Acceptance

- A. **As-built Plan Approval:** An as-built plan is required for all publicly maintained storm drain, and public and privately maintained SWM and all ESD facilities. As-built drawings are required to be submitted and approved by DPIE before final facility acceptance. As-built drawings for MD-378 ponds are required to be submitted within 30 days of initial construction of the facility (a “dam safety” as-built) and then again at completion of the facility construction, when the facility is converted from temporary sediment basin to permanent SWM pond. The as-built plan approved by DPIE will be used to conduct the final site inspection.
- B. **Final Inspection:** Upon completion of the storm drain, storm water facilities, and ESD devices (as well as all other aspects of work such as paving, sidewalk, street trees and lights, and grading included in the permit) and with the approved as-built drawing, the DPIE Site/Road Inspector will conduct a final inspection, as a requirement to issue a Final Inspection Memo. For any publicly maintained storm drain, SWM, or paving, the Site/Road Inspector could be accompanied by staff from DPW&T Office of Highway Maintenance, DPW&T Traffic Section, DPW&T Street Light Section, or DPW&T Bridge Division as appropriate. The inspectors will verify if the work is constructed in accordance with the permit drawings and issue a punch list (Appendix 14-3) for any deficiency. (County Code Sec. 32-192)
- C. **Final Approval by Inspection Division:** Upon satisfactory completion of all punch list items, the DPIE Site/Road Inspector will forward to the DPIE Site/Road Permit Processing Unit the recommendation to release the bond and close out the permit.
- D. The permittee will supply to the DPIE Site/Road Inspector any operating manuals, gate keys, valve handles, or other required materials for any structures, equipment, or apparatus associated with any publicly maintained facility.

#### 14.8 General Inspection Measures

General inspection requirements that apply to all inspected systems are summarized below. Construction Inspection Checklists for various types of drainage facilities are included in Appendix 14-4. These specific inspection checklists apply to an individual storm drain, SWM, or ESD device, and will be provided by the DPIE Site/Road Inspector at the preconstruction meeting, which must be held just prior to starting construction on the site work for the devices. The design plan will include the specifications for the types of devices, as well as a basic sequence of construction. The following is a summary of anticipated site for the device that will be performed to install the ESD or SWM devices. Each type of BMP device will require some, but not all, of the following construction steps.

- A. **Preconstruction Meeting:** This meeting provides an opportunity to review the plans, discuss the purpose of the site drainage devices or systems, and answer questions regarding construction and/or inspection procedures. This is not the project pre-

construction meeting held prior to start of clearing and grading. This meeting is required prior to the start of construction of any device or series of devices to be installed. If appropriate, construction stakeout of the device shall be in place prior to inspection, to allow for confirmation by the County inspector at the pre-construction meeting.

Copies of the latest Inspection Checklists for the type of facility to be constructed will be provided by the County inspector. It is incumbent upon the permittee's representative and the County inspector to initial and date the checklist. The completed checklist will be submitted with the as-built drawings.

The permittee or agent must request inspections at least 48 hours in advance, not including weekends or holidays, by calling (301) 883-5710 or by contacting the previously assigned County inspector. When a call is made to request an inspection, enter the permit number, type of inspection, and contact phone number. Inspections cannot be guaranteed to be performed at a specific time of day.

- B. **Erosion and Sediment Control:** The approved Final Grading, Erosion and Sediment Control Plan shall clearly indicate where storm drain or storm water device areas are located and what sediment control measures will be used for protection during construction of the devices. These storm water areas shall be clearly marked in the field and shall not receive sediment-laden runoff prior to project completion unless specifically permitted by the Erosion and Sediment Control Plan. Final grading and construction for the device installation shall not take place until the surrounding site is permanently stabilized, including building construction and base paving as directed by the approved plan. Use of the device location for sediment control measures is not permitted unless shown on the approved Erosion and Sediment Control Plan.
- C. **Site Disturbance and Tilling:** Operation of construction vehicles and equipment shall avoid areas receiving disconnected runoff, or permeable paving to minimize disturbance and compaction. Buffer areas shall not be disturbed (i.e., cleared or graded) during construction, except for temporary impacts associated with incidental utility construction or mitigation and afforestation projects. Any temporary impacts shall be immediately repaired and stabilized. If areas receiving disconnected runoff become compacted, scarifying the surface or rototilling the soil to a depth of 4 to 6 inches shall be performed to ensure permeability. Additionally, amendments may be needed for tight, clayey soils.
- D. **\*Excavation of ESD device surface area:** Inspection is required during the excavation phase to verify trench dimensions and to check soils for infiltration. If adjacent to trees, the edge of the excavation shall be root pruned to a depth of at least 2 feet to avoid tearing the tree roots. The guidance of an arborist during root pruning is required if the adjacent tree is greater than 20-inch dbh or is a specimen tree.
- E. **Soil Compaction:** The bottom areas of ESD devices shall not be compacted. Excavation should be conducted in dry conditions, with equipment located outside of the practice to minimize bottom and sidewall compaction. Existing soils in the location of enhanced

filters should be scarified to a depth of 4 to 6 inches, to maximize infiltration. In wetland areas, construction should be performed with lightweight, wide-tracked equipment to minimize disturbance and compaction. Excavated materials shall be placed in an area protected by an approved Final Grading, Erosion and Sediment Control Plan.

- F. **Sub base Installation:** The sub base of the device structure shall be placed in lifts and lightly rolled according to the specifications on the plan approved by DPIE. Sub base aggregate should be clean, washed, and free of fines.
- G. **Geotextile Fabric:** Geotextile fabric shall not be installed on the bottom of any device practice. The device practice may be constructed as an excavated area in natural ground and backfilled with sand, gravel, and media soil. These applications shall use non-woven geotextile fabric, meeting the MSHA specification from Section 921-09-01, to line the sides of the facility to prevent clogging. An approved geotextile fabric shall be cut to conform to the excavation perimeter. A 6-inch minimum overlap is required between strips of the fabric. Extruding tree roots or other obstacles must be removed from the trench walls and base by root pruning to prevent the fabric from tearing.
- H. **Observation Well/Cleanout:** The observation well with perforated pipe must be installed as specified on plans prior to stone placement and shall rest on a 12-inch square block of stone or concrete paver, or shall be capped. Perforations shall not extend beyond the gravel trench. The observation well must be capped and set at least 4 inches above grade for landscape areas and at grade when located in mowed areas.
- I. **\*Distribution System:** The over drain, underdrain, and distribution pipes shall be verified to ensure that both the material and perforations meet specifications shown on the design plan. The upstream ends of pipes should be capped prior to installation. All underdrain or distribution pipes used may be installed flat (0%) or at a slight positive slope at the design invert.
- J. **Soil Media Installation:** Bio retention soils may be mixed onsite before placement. The soils should not be placed under saturated conditions. The County standard soil specifications on the permit drawings shall be used unless the County inspector provides a County approved updated specification at the pre-construction meeting. This action may happen if the County determines a specific standard is not appropriate and therefore requires a revision to the specification.

The soil media should be placed and graded using excavators or backhoes that are operating adjacent to the practice. The soil media shall be placed in horizontal layers (12 inches per lift maximum). Proper compaction of the media will occur naturally. Spraying or sprinkling water on each lift until saturated may quicken settling times.

- K. **Backfilling of Sand and Gravel:** The sand shall be composed of clean, washed material meeting ASTM C-33 specifications. Manufactured sand is not an acceptable substitute.

The aggregate shall be composed of clean washed, uniformly graded material. Rounded bank run gravel is recommended and shall meet ASTM C-33 for the stone size specific to the device gravel size noted on the design plan. Bluestone is acceptable providing it is from an approved supplier, and is double washed in accordance with Prince George's County Specifications. Recycled concrete is not acceptable.

Placement of material is to be observed. Care must be used when dumping the material to ensure the geotextile fabric does not tear. The material shall be placed in horizontal layers (6 inches per lift maximum) over the entire area of the practice using excavators or backhoes operating adjacent to the practice.

- L. **Landscape Installation:** The optimum planting time is during the autumn months. Spring is also acceptable, but landscape material may require watering. The landscaping shall be installed prior to the addition of mulch.
- M. **\*Final Inspection:** Upon grading and stabilization (mulch is considered stabilized) of the area, if the above items have been completed satisfactorily, a final inspection report will be initiated by the inspector.
  1. The final inspection of the device is required before requesting a Final Use & Occupancy permit from the inspector.
  2. For all publicly maintained storm drain, ESD, or SWM systems and all private ESD or SWM systems, an approved as-built plan must be submitted and approved by the County prior to scheduling a final inspection for release of the Site Development Rough Grading Permit, Site Development Fine Grading Permit, or the Street Construction Permit. A private storm drain system will require a certification that the installation was in conformance with the approved plans to release the permit.

#### 14.8.1 Structural Measure Inspection Requirements

##### 14.8.1.1 Storm Drain Pipe

The following inspections as indicated by \* are County required inspections for the construction of a storm drain system. Additional inspections may be required and noted by the DPIE Site/Road inspector.

- A. **\*Preconstruction Meeting**
- B. **Erosion and Sediment Control**
- C. **\*Installation of Pipe or Structures:** Inspections are to be made during the installation of pipe and/or structures. The permittee is responsible for providing inspection and testing services sufficient to certify the storm drain was installed in accordance with the plans and specifications. This includes proper bedding, correct pipe installation, use of rubber gaskets,

compaction requirements, and other conditions were met. The latest version of the inspection guidelines will be provided by the DPIE Site/Road Inspector at the time of the preconstruction meeting. Generally, inspection will be provided at the following stages by the Field Engineer in accordance with the Construction Checklist in the appendix.

1. At the beginning of excavation, to include subgrade inspection.
2. During pipe laying and backfill, to include bedding material, pipe installation, and compaction of backfill.
3. Steel/rebar inspection, if applicable.
4. Placement of precast or construction of cast-in-place structures with appropriate bedding.
5. Pipe connection and sealing at structures.
6. During placement of riprap, geotextile fabric, and cutoff wall.
7. Abandonment procedures of pipe and structures.
8. Prior to final inspection, the storm drain system must be cleaned of all silt and debris as approved by the DPIE Site/Road Inspector, and a video of the pipe 48 inches or smaller must be prepared and provided to the County.

A copy of the pipe, structures, and material delivery tickets, shall be made available to the Site/Road Inspector if requested and submitted with the as-built drawings. A copy of the delivery tickets shall remain on the job site during storm drain construction.

**D. \*Final Inspection**

**14.8.2 Retention or Detention Pond (MDE Devices P1 to P5 and W1 to W4)**

The following inspections as appropriate for the approved plans indicated by \* are required for the construction of a pond. Also, refer to the approved Sediment and Erosion Control Plan for additional steps or guidance. Additional inspections may be required as noted by the inspector. The inspections (except the final inspection) are required at the start of each stage.

- A. \*Preconstruction Meeting:**
- B. Erosion and Sediment Control Installation:**
- C. Clear, Grub, and Subgrade Preparation:**

- D. **\*Core Trench Excavation and Dewatering:** Excavation of core trench shall take place as specified on design plans. The side slopes shall be 1:1 or flatter. Removal of standing water within the excavation may also be necessary. The removal of groundwater shall be directed by a Geotechnical Engineer or as noted on the plan or geotechnical report.
- E. **Riser Structure:** The precast riser structure shall be inspected by the Engineer or DPIE Site/Road Inspector before unloading the truck. The DPIE Site/Road Inspector shall verify that the shop drawing has been approved by DPIE and compare the dimensions to the shop drawing. A copy of the approved shop drawing shall be maintained by the design consultant, the DPIE Site/Road Inspector, and in the permit file. The goal is to minimize cutting into the concrete riser structure for openings that are not the correct size. The structure can be rejected for the following reasons:
1. The riser openings are too small and therefore would require cutting of the precast concrete. In general, riser openings too large may be acceptable, as the opening can be easily modified to be smaller in the field. Contact the DPIE District Engineer to verify.
  2. Major cracks in the concrete.
  3. No reinforcing steel shall be visible.
  4. A minimum of 3 inches concrete clearance from any riser openings and a joint or corner.
  5. Any modification to the structure that would expose rebar.

If the structure is rejected, it shall be marked by County Inspector as rejected and immediately removed from the site.

The riser structure will not be placed on gravel. If bedding is required, a concrete mud mat is an acceptable substitution for gravel.

- F. **\*Core Trench Backfill** – The backfill shall follow the requirements of MD-378 or as modified on the approved plan.
1. Fill material from approved designated borrow areas must be free of roots, stumps, wood, rubbish, stones greater than 6 inches, and frozen or other objectionable materials.
  2. Fill material shall conform to Unified Soil Classification GC, SC, CH, or CL and must have at least 30% passing the #200 sieve.
  3. Fill is to be placed in layers a maximum of 8 inches thick (before compaction), which are to be continuous over the entire length of the fill. The entire surface of each lift shall be traversed by not less than one tread track of heavy equipment, or compaction shall be achieved by a

minimum of four complete passes of a sheeps-foot, rubber tired, or vibratory roller. The Geotechnical Engineer shall verify the 95% compaction of maximum dry density with a moisture content within +/- 2% of the optimum using AASHTO method T-99 (Standard proctor)

4. A letter from a Maryland Registered Professional Engineer certifying the installation of the core trench is required upon its completion and prior to beginning construction of the embankment and shall be submitted to the District Engineer.

**G. \*Construction and Backfilling of Principal Spillway** – The backfill shall follow the requirements of MD-378 or as modified on the approved plan.

1. Subgrade for principal spillway footing;
2. After forming and placing reinforcing steel, but prior to pouring concrete for anti-seep collar(s), footings, walls, and top slab of the principal spillway.
3. Pipe properly assembled and a pipe joint within 4 feet of riser structure.
4. Concrete cradle, anti-seep collars, and concrete collars properly installed.
5. When backfilling around the outlet pipe and anti-seep collars and;
6. If applicable, the filter diaphragm installed in accordance with plans and geotechnical engineer's instructions.
7. Steel in cast-in-place end wall at outfall.
8. Concrete cylinder break reports are required for all cast-in-place riser footings, walls, top slabs, antiseep collars, concrete cradle, and collars.

**H. \*Construction of Embankment**

The Geotechnical Engineer will verify compaction of embankment and fill material to ensure it is compliant with MD-378. The facility must be constructed to the "constructed elevation," which is noted on the approved plan to provide an allowance for settlement.

**I. Riprap Outfall**

**J. Stabilization and Landscaping**

**K. As-Built Drawings:**

As-built drawings of the Dam Safety or Final SWM plan will be submitted within 30 days of completion to DPIE for approval and subsequent approval by PGSCD.

**L. \*Final Inspection**

### 14.8.2.1 Minor Pond Plan Changes/Revision Procedures

The following items represent field conditions that result in minor changes in the approved pond plan that may be approved as directed by the inspector.

- A. Shift in location of plantings or addition of landscaping not on embankment or in storage area or emergency spillway.
- B. Additional riprap in outfall, provided that rights-of-way and/or easements are not crossed (no change in size)

### 14.8.3 Infiltration Trench (MDE Device I-1)

The following inspections as indicated by \* are required for construction of an infiltration trench. Additional inspections may be required and noted by the DPIE Site/Road Inspector. The inspections (except final inspection) are required at the start of each stage.

- A. **\*Preconstruction Meeting**
- B. **Erosion and Sediment Control**
- C. **\*Excavation of Device**
- D. **Soil Compaction**
- E. **Geotextile Fabric**
- F. **Observation Well/Cleanout**
- G. **Distribution System**
- H. **\*Backfilling of Sand and Gravel.**
- I. **Installation of Final Cover.** Gravel surface is to be completely covered with geotextile fabric and backfilled with topsoil. Surface inlets are to be constructed as stated on the plans.
- J. **\*Final Inspection.**

### 14.8.4 Surface Sand Filter (MDE Device F-1)

The following inspections as indicated by \* are required for the construction of a **Surface Sand Filter**. Additional inspections may be required and noted by the inspector. The inspections (except the final inspection) are required at the start of each stage.

- A. **\*Preconstruction Meeting**



- B. Erosion and Sediment Control
- C. \*Excavation of Device Area
- D. Soil Compaction
- E. Observation Well/Cleanout
- F. Distribution System
- G. Backfill of Sand or Gravel
- H. \*Final Inspection

#### 14.8.5 Underground Sand Filter (MDE Device F-2)

The following inspections as indicated by \* are required for the installation of an underground sand filter system. Additional inspections may be required and noted by the DPIE Site/Road Inspector.

- A. \*Preconstruction Meeting
- B. Erosion and Sediment Control
- C. Excavation of Device Area
- D. Sub base Installation
- E. \*Construction of Vault
- F. Distribution System
- G. Installation of Filters
- H. \*Final Inspection

#### 14.8.6 Bio retention Systems (MDE Device F-6)

The following inspections as indicated by \* are required for the installation of bio retention systems. Additional inspections may be required and noted by the DPIE Site/Road Inspector.

- A. Preconstruction Meeting
- B. Erosion and Sediment Control
- C. \*Excavation of Device Area

- D. **Soil Compaction**
- E. **Geotextile Fabric**
- F. **Observation Well/Cleanout**
- G. **Distribution System**
- H. **\*Backfilling of Sand and Gravel**
- I. **\*Soil Media Installation**
- J. **Landscaping**
- K. **Mulch:** No mulch shall be applied until the Engineer has verified the installation of the "Soil Media" is installed to the correct elevation.
- L. **\*Final Inspection**

#### 14.8.7 **Underground Detention System**

The following inspections as indicated by \* are required for the construction of an **underground detention structure**. Additional inspections may be required and noted by the inspector. The inspections (except the final inspection) are required at the start of each stage.

- A. **\*Preconstruction Meeting**
- B. **Erosion and Sediment Control**
- C. **Excavation of Device Area**
- D. **Sub base Installation**
- E. **\*Construction of Detention Systems:** Inspection(s) will be made during the construction of the detention system at the following phases:
  1. Approval of subgrade for footings of pipe and inlet/outlet structures
  2. During pipe installation and backfill.
  3. Inlet/outlet structure footings, walls, and top slab formed and steel set prior to pouring.
  4. Concrete cylinder break reports are required for the footings, walls, and top slabs of all cast-in-place inlet/outlet structures.
- F. **\*Final Inspection**

### 14.8.8 Hydrodynamic Separator

The following inspections as indicated by \* are required for the installation of a hydrodynamic separator. Additional inspections may be required and noted by the inspector. For example, sediment control measures may be required as a part of the sediment control, or to protect the future function of the separator and associated devices.

- A. **\*Preconstruction Meeting**
- B. **Erosion and Sediment Control**
- C. **Excavation of Device Area**
- D. **Sub base Installation**
- E. **\*Placement of Hydrodynamic Structure:** Inspections will be made prior to placement of the hydrodynamic separator to ensure the subgrade is firm, and any required bedding material is placed prior to installation.
- F. **\*Final Inspection**
  - 1. A letter of certification from the manufacturer is required stating the structure was built to specification. This shall be provided to the DPIE Site/Road inspector and engineer.

## 14.9 Inspection Requirements for Nonstructural ESD Practices

### 14.9.1 Alternative Surfaces

#### 14.9.1.1 Green Roofs A-1

The following items should be addressed during construction of projects with Green Roofs:

- A. **\*Preconstruction Meeting:** The DPIE Site/Road and Building Inspectors shall be present at this meeting and all inspections of the installation.
- B. **\*Waterproofing Installation:** Measures shall be taken to prevent membrane damage during green roof installation. Any flaws, irregularities, or conditions that may cause leaks or roof damage shall be identified and repaired. The waterproofing membrane should be visually inspected and tested for water tightness prior to installation of the planting mix.

1. The following certifications by the Licensed Architect shall be required during construction:
  - a. Prior to placement of the waterproofing, drainage, and treatment materials, certification that the constructed roof meets the load bearing capacity specified on the approved plans.
  - b. After its installation and prior to placement of the planting media and stock, certification regarding the water tightness of the waterproofing membrane.
- C. **Sloped Roof Stabilization Measures:** Where required, slope stabilization measures will be placed prior to green roof installation. In some situations, slope stabilization may be integrated into the roof structure.
- D. **Green Roof Installation:** Green roof systems should be installed according to the manufacturer's instructions. Generally, root-barrier layers, walkways, and irrigation systems should be installed first.
  1. \*During placement of the drainage system.
  2. \*During placement of the planting media.
  3. \*Upon installation of the plant material.
- E. **\*Final Inspection**

#### 14.9.1.2 Permeable Pavements A-2

The following items should be addressed during construction of projects with permeable pavement:

- A. **\*Preconstruction Meeting**
- B. **Erosion and Sediment Control**
- C. **Excavation of Device Area**
- D. **Soil Compaction**
- E. **Observation Well/Cleanout**
- F. **\*Distribution Systems**
- G. **\*Backfilling of Sand and Gravel**

**H. Permeable Paving Material****I. \*Final Inspection****14.9.1.3 Reinforced Turf A-3**

The following items should be addressed during construction of projects with reinforced turf:

**A. \*Preconstruction Meeting****B. Erosion and Sediment Control****C. Excavation of Device Area****D. Soil Compaction****E. Observation Well/Cleanout****F. \*Distribution Systems****G. \*Backfilling of Sand and Gravel****H. Reinforced Material****I. \*Final Inspection****14.9.2 Nonstructural Practices****14.9.2.1 Disconnection of Rooftop Runoff N-1**

The following items should be addressed during the construction of projects with planned rooftop disconnections:

**A. \*Preconstruction Meeting****B. Erosion and Sediment Control****C. Site Disturbance and Tilling****D. \*Final Inspection****14.9.2.2 Disconnection of Non-Rooftop Runoff N-2**

The following should be addressed during construction of projects with non-rooftop disconnections:

**A. \*Preconstruction Meeting**

- B. Erosion and Sediment Control
- C. Site Disturbance and Tilling
- D. \*Final Inspection

#### 14.9.2.3 Sheet Flow to Conservation Areas N-3

The following should be addressed during construction of projects with sheet flow to conservation areas:

- A. \*Preconstruction Meeting
- B. Erosion and Sediment Control
- C. \*Site Disturbance and Tilling
- D. \*Final Inspection

### 14.9.3 Micro-Scale Practices

#### 14.9.3.1 Rainwater Harvesting (Cisterns and Rain Barrels) M-1

The following should be addressed during construction of projects with rainwater harvesting systems:

- A. **Site Disturbance:** Underground storage tanks shall be placed on or in native soils. If placement on fill material is necessary, a geotechnical analysis may be required by the approving authority.
- B. **Storage Tanks**
- C. **Distribution System:** Installation of a sprinkler system.
- D. **Pressurization:** Depending on the use of stored water, pressurization may be required. To add pressure, a pump or pressure tank can be used.
- E. **\*Final Inspection:** Prior to operation, certification shall be required that the constructed system meets the conditions specified on the approved plans. Additionally, certification regarding the water tightness of the underground storage tank shall be required after its installation.

#### 14.9.3.2 Submerged Gravel Wetlands M-2

The following items should be addressed during the construction of projects with submerged gravel wetlands.

- 
- A. **\*Preconstruction Meeting**
  - B. **Erosion and Sediment Control**
  - C. **\*Excavation of Device Area:** Shall be performed with lightweight, wide-tracked equipment to minimize disturbance and compaction. Excavated materials shall be placed in a contained area. Any pumping operations shall discharge filtered water to a stable outlet
  - D. **Soil Compaction**
  - E. **Observation Well/Cleanout**
  - F. **\*Distribution Systems**
  - G. **\*Geotextile Fabric**
  - H. **\*Backfilling of Sand and Gravel**
  - I. **Soil Media Installation**
  - J. **Landscape Installation**
  - K. **\*Final Inspection**

#### 14.9.3.3 Landscape Infiltration M-3

The following items should be addressed during construction of projects with landscape infiltration:

- A. **\*Preconstruction Meeting**
- B. **Erosion and Sediment Control**
- C. **\* Excavation of Device Area**
- D. **Planter Boxes:** Planter boxes may be made of stone, brick, or concrete.
- E. **Observation Well/Cleanout**
- F. **\*Backfilling of Sand and Gravel**
- G. **\*Soil Media Installation**
- H. **Landscape Installation**
- I. **\*Final Inspection**

**14.9.3.4 Infiltration Berms M-4**

The following items should be addressed during construction of projects with infiltration berms:

- A. **\*Preconstruction Meeting**
- B. **Erosion and Sediment Control**
- C. **\*Excavation of Device Area**
- D. **Soil Compaction**
- E. **Observation Well/Cleanout**
- F. **\*Backfilling of Sand and Gravel**
- G. **Soil Media Installation**
- H. **Implementation with Other Practices:** When infiltration berms are incorporated into a system using other practices (e.g., Disconnection of Non-Rooftop Runoff), the construction criteria for that practice shall also be considered.
- I. **\*Final Inspection**

**14.9.3.5 Dry Wells M-5**

The following items should be addressed during construction of projects with dry wells:

- A. **\*Preconstruction Meeting**
- B. **Erosion and Sediment Control**
- C. **Excavation of Device Area**
- D. **Underground Chamber:** A subsurface prefabricated chamber may be used.
- E. **\*Observation Well/Cleanout**
- F. **Geotextile Fabric**
- G. **\* Distribution System**



- H.    \* Backfilling of Sand and Gravel
- I.    \*Installation of Final Cover: Gravel surface is to be completely covered with geotextile fabric and backfilled with topsoil.
- J.    \*Final Inspection

#### 14.9.3.6        **Micro-Bio retention M-6**

The following items should be addressed during construction of projects with micro-bio retention:

- A.    \*Preconstruction Meeting
- B.    Erosion and Sediment Control
- C.    \*Excavation of Device Area
- D.    Soil Compaction
- E.    \* Geotextile Fabric
- F.    \*Observation Well/Cleanout
- G.    Distribution System (If applicable)
- H.    \*Backfilling of Sand and Gravel
- I.    \*Soil Media Installation
- J.    Landscape Installation
- K.    \*Final Inspection

#### 14.9.3.7        **Rain Gardens M-7**

The following items should be addressed during the construction of projects with rain gardens:

- A.    \*Preconstruction Meeting
- B.    Erosion and Sediment Control
- C.    \*Excavation of Device Area
- D.    Soil Compaction

- E. **Soil Media Installation:** If poor soils are encountered beneath the rain garden, a 4-inch layer of washed gravel (1/4- to 3/4-inch gravel preferred) may be used below the planting soil mix.
- F. **Landscape Installation**
- G. **\*Final Inspection**

#### 14.9.3.8 Swales M-8

Construction specifications for swales can be found in Appendix B.3. In addition, the following items should be addressed during the construction of projects with swales:

- A. **\*Preconstruction Meeting**
- B. **Erosion and Sediment Control:** Swales are often used for conveying runoff to sediment trapping devices during site construction. Care should be taken to ensure proper construction where storm water management swales are used for this purpose. After the drainage area is completely stabilized, accumulated sediment should be removed and the swale excavated to the required dimensions. Any required infrastructure (e.g., check dams, underdrains) may then be installed, the bottom and side slopes scarified, and a good stand of vegetation established.
- C. **Excavation of Device Area**
- D. **Soil Compaction**
- E. **Geotextile Fabric**
- F. **\*Observation Well/Cleanout**
- G. **Distribution System**
- H. **\*Backfilling of Sand and Gravel**
- I. **\*Soil Media Installation**
- J. **Landscape Installation**
- K. **\*Final Inspection**

#### 14.9.3.9 Enhanced Filters M-9

The following items should be addressed during the construction of projects with enhanced filtering practices:

- A. \*Preconstruction Meeting
- B. Erosion and Sediment Control
- C. \*Excavation of Device Area
- D. Soil Compaction
- E. \* Geotextile Fabric
- F. \*Observation Well/Cleanout
- G. Distribution System
- H. \*Backfilling of Sand and Gravel
- I. \*Soil Media Installation
- J. Landscape Installation
- K. \*Final Inspection

---

## Chapter 15 AS-BUILT PLANS

### 15.1 Administrative Procedures for Submitting As-Built Plans

As-built plans are required for all public drainage systems and all ESD and SWM facilities, both public and private. Private storm drain systems do not require an as-built drawing, but must be certified by the design consultant that the pipe size, type, slope, and location generally conform to the approved design plan. The as-built plans are required to document the state of the system at the time of construction completion. This applies to both public and private facilities, per County Code Sec. 32-191(d). The necessary information to include on the as-built plan and in the submittal packages is contained in the individual review checklists available on the County website. The design consultant (Professional Engineer or Surveyor) shall complete the checklist for the various types of facilities and include it with the submittal.

Upon completion of the storm drain system, submission of a storm drain as-built plan may be prepared at any time. The following information must be properly shown on all as-built plans or included with the submittal package for acceptance by DPIE:

- A. Job title.
- B. Words "As-Built" in or near the title block.
- C. Applicable as-built certification(s), COMAR Certification (if applicable), and signed professional seal.
- D. The appropriate DPIE approval blocks with case/permit number(s). All original permit approvals and signatures must be legible. Include the applicable permit number for projects located within the jurisdiction of other local governments (e.g., City of Greenbelt).
- E. Partial storm drain as-built plans may not be submitted. All storm drain as-built submissions shall include the entire permitted system. Submissions of phased projects shall reflect all sections pertaining to the permit of reference. All other sections or entities (ESD/ SWM) shall be excluded.
- F. Completed checklist for each type of device on the as-built plan. (See County website for latest version)
- G. Each submittal shall be submitted with a separate transmittal. The transmittal shall include the following information:
  1. Manufacturer's delivery tickets for pipe, structures, and other materials and certifications as applicable.
  2. Completed construction inspection checklist with permittee's consultant and County inspector signoff.

3. Geotechnical inspection reports with certification letter from geotechnical engineer. The certification letter shall be specific of the items, materials, testing requirements, and other pertinent details relating to construction of the referenced design or project.
4. Video of public storm drain system for all pipes 48 inches or less in height.
5. Recording information (liber and folio) for all storm drain, SWM, and/or surface drainage easements noted if not already on plan.

Number of Copies to submit:

1. For Review Only
  - a. Transmittal
  - b. One Set of Design Plans (include previous review comments if it is a resubmittal.
  - c. For SWM plans only, one set of the computations, an updated MD-14 form, and the Small Pond Approval Letter for any SWM facility approved by PGSCD is required.
2. Storm Drain, Stormwater Management, and ESD Plans
  - a. For Approval
    1. Consultant's Transmittal
    2. Reproducible Mylar
  - b. For County Records
    1. Electronic copy of plan in .pdf format per County requirements.
    2. CAD files per requirements identified in Appendix 11
    3. Electronic copy of Computations and Drainage Area Map
    4. Six Sets of Plan Prints to be distributed after approval.
  - c. For SWM Facilities Only  
  
Electronic copy and two sets of the computations, updated MD-14 form, and the Small Pond Approval Letter for any SWM facility

approved by PGSCD. They will be transmitted by DPIE to PGSCD.

## 15.2 Information Presentation

The presentation of the data on an as-built plan shall reflect as-built dimensions, sizes, slopes, and other construction relevant information in **RED**. Information shall be presented in tables whenever possible. The provision of tables that can be formatted to allow for addition of the as-built data should be considered during the design phase. The level of accuracy shall be to the significant figures shown on the design plan. This generally would require to two decimal places (0.01) for top of structures and pipe inverts and one decimal place (0.1) for grading, unless additional information is needed to show positive drainage.

All ESD and SWM as-built plans should include insets that reflect the as-built components only, including but not limited to contours, spot shots, pipes or outfall systems, text labels, and other appurtenances. For further information for each type of device, refer to the As-Built Checklist section for more specific information. The as-built topography will be shown on the plan sheet overlaying the existing design during its review only. It will only be used for verification of the location during review. The final as-built drawings will not show this overlay. Instead, an additional insert is required to show the as-built grading contours, spot elevations, structures, property limits, and SWM easement.

## 15.3 As-Built Plan

Specific information to be provided for the various types of devices and facilities on an as-built drawing are provided in each section below:

### 15.3.1 Public Storm Drain ONLY Plan

The intent of a storm drain as-built is to represent the constructed elevations, slopes, and construction materials to meet the project's design specifications and to ensure that proper pipe sizes were used and slopes are sufficient to maintain pipe cleansing velocities. It is recommended that a storm drain as-built be submitted no later than after base paving completion. The review and acceptance of the as-built drawings is the first of several steps necessary to obtain "final inspection" and subsequent bond release(s).

For plan views, a note on each plan sheet stating that the pipe sizes were installed in accordance with the design if the sizes did not change. If there was a pipe size change, the pipe size will be boxed with the revised pipe size adjacent to the design pipe size. In addition, ties will be provided for yard inlets in order to verify they are located within the storm drain easement. Lastly, any structure not constructed shall be noted on the plan view.

Pipe profiles will have the following information in a box:

- A. Actual slopes,
- B. Actual inverts, and
- C. Storm drain pipe distance to the nearest foot between structures.

Only if the pipe size or other dimensions have changed will a box with the revised size be required on the profiles. In addition to the information shown on the pipe profiles, information for the structure table will be required.

The yard inlets throat or grate elevation must be verified against the design overflow elevation to ensure no more than 2 feet of ponding would be present. An as-built spot elevation at the overflow location is also acceptable to provide confirmation that the overflow depth is less than 2 feet when the yard inlet is installed.

The submittal package should include the manufacturer's delivery tickets for pipe, structures, materials, and other relevant items used for construction of the storm drain system. The geotechnical report shall also be provided and shall provide corroborating information such as relevant test results, street compaction for street fill and backfill of the storm drain pipe.

The as-built certification provided on each sheet shall be signed and sealed by a licensed Professional Engineer or Professional Land Surveyor and state:

*"I hereby certify to the best of my knowledge and belief that this As-Built truly represents existing field conditions including but not limited to sizes, diameters, line and grade, and elevations."*

### **15.3.2 Stormwater Management Pond (MD-378)**

According to Maryland State law, a dam safety as-built drawing at minimum must be submitted for review within 30 days of construction of an SWM pond. For a facility that is being constructed for SWM only, this requirement shall be met upon construction completion. However, where the SWM facility is also being used as a sediment basin or other interim measure, the dam safety as-built must be prepared within 30 days of the completion of the sediment basin construction.

PGSCD and the *Soil Erosion and Sediment Control-Pond Safety Reference Manual* dated July 2013 provide the specific information that is required to be shown on the as-built drawing. Only a Professional Engineer may certify that the MD-378 facility has been constructed in accordance with the design plans and specifications. See County Code Sec. 32-192 for additional information. The submitted information includes an as-built drawing, completed checklist, inspection geotechnical reports with test results for embankment compaction, type of soil for embankment, other soil used for the construction of the facility, concrete break tests, and other material used in the construction.

Dimensions of buried structures may be provided by either the Geotechnical Engineer or the design consultant of record. The Geotechnical Engineer shall provide a one-page letter stating that the construction of the facility was in accordance with the design plans and MD-378 specifications and approved by DPIE and PGSCD. The letter shall be included on the as-built plan.

SWM as-builts require the overlay as-built contours on the proposed design. The overlay also includes underlying existing contours on the design drawings. This is used to verify the facility is located in accordance with design. It will only be used for verification of the location during review. The final as-built drawings will not show this overlay. Instead, an additional insert is required to show the as-built grading contours, spot elevations, structures, property limits, and SWM easement.

A dam safety as-built will need to verify the as-built WSEL by one of two options based on the original design.

- A. If the required sediment control storage was approximately equal to or greater than the required SWM storage, the analysis will be based on the as-built weir dimensions and elevations, as-built emergency spillway dimensions and elevations (if constructed), and as-built storage. It will be assumed by the design consultant there is NO storage available below the weir crest, and the TR-20 analysis will confirm the required freeboard to the 100-year SWM (blocked condition) design elevation based on the sediment control runoff curve number, drainage area, and  $T_c$ , or SWM RCN, DA, and  $T_c$ , whichever is worst.
- B. If the required sediment control storage was less than the required SWM storage, a different analysis is required. First, the approved profile sheets from the sediment control plan should be analyzed, and then the WSEL should be evaluated based on the as-built weir dimensions and elevations, as-built emergency spillway dimensions and elevations, and as-built storage. Prepare a TR-20 analysis based on no storage available below the weir crest and the TR-20 analysis will need to confirm the required freeboard to the design elevation based on the sediment control RCN, DA, and  $T_c$  for the 100-year storm event.

The as-built package will also include a copy of the drainage area map and revised computations if the storage volumes are less than 95% of design volume or if the structure elevations are more than 0.2 foot different from the design, provided the 0.2-foot difference does not violate the minimum 2 feet of freeboard.

An SWM as-built plan may only be signed and sealed by a Professional Engineer. The following certification from PGSCD shall be used.

*"I hereby certify that to the best of my knowledge that this As-Built is in compliance with the design, and the pond/basin as constructed meets the requirements of the Maryland*



*Soil Conservation Service- Maryland Standards and Specifications for ponds (MD-378) and/or the appropriate standards and specifications on the approved Stormwater Management Plan."*

### **15.3.3 ESD and Structural Water Quality Devices**

The applicable checklist with multiple sections includes the required information for all other structural and nonstructural devices and is available from the DPIE website. As noted in County Code Sec. 32-192 (d), the As-Built drawings shall comply with the specifications on the approved plans. In addition to the measurements of the device(s), the information to be provided shall include but is not limited to "made soil", sand, gravel, pipe, geotechnical report with test results, other relevant items, as required by the county reviewer, based on the type of device., the manufacturer's delivery tickets, material certification, landscape material, size and type, and verification that the device meets the required storage. The as-built measurements shall be based on the elevation of the surface of the "made soil" surface and not the top of the mulch layer. Any piping system both for the dewatering or diversion from a splitter system shall be noted as well as the location of observation wells.

The as-built certification provided on each sheet shall be signed and sealed by a licensed Professional Engineer or Professional Land Surveyor and state:

*"I hereby certify to the best of my knowledge and belief that the storm water management facilities (both BMP and ESD) shown on the plans have been constructed in accordance with the plans and specifications approved by Prince George's County Department of Public Works and Transportation."*

### **15.3.4 Private Storm Drain Systems**

Certification letters for private storm drains shall be provided directly to the DPIE inspector.

## **15.4 Delivery Tickets**

Delivery tickets for material delivered to the job site for pipe and materials will need to be included with the as-built submittal. They may be provided electronically or a paper copy of the delivery ticket. It is the responsibility of the Registered Professional Engineer or Surveyor who is preparing the as-built drawing to verify if the correct quantities and types of materials meet the plan design and specifications.

---

## GLOSSARY

*Portions of this glossary were adopted from the 1994 & 2011 Maryland Standards and Specifications for Soil Erosion and Sediment Control and the 2000 Maryland Stormwater Design Manual, Volumes I & II (MDE, 2000 and 2009) prepared by the Maryland Department of the Environment.*

**ACCELERATED STABILIZATION** - The providing of temporary or permanent cover by the end of the work day to prevent erosion.

**ACID SOIL** - A soil giving an acid reaction below a pH of 6.6 throughout most or the entire portion occupied by roots.

**AESTHETIC MAINTENANCE: Aesthetic maintenance of drainage and storm water management systems** shall include mowing, weeding, mulching, raking, removal of debris, replacement of landscaping, restoration and repair of existing features including grass, lawn, walkways, trails, fencing, signs, walls and repair due to erosion.

**ANTI-SEEP COLLAR** - An impermeable diaphragm usually of sheet metal or concrete installed at intervals within the zone of saturation along the conduit of a principal spillway to increase the seepage length along the conduit and thereby prevent piping or seepage along the conduit.

**ANTI-VORTEX DEVICE** - A device designed and placed on the top of a riser or the entrance of a pipe to prevent the formation of a vortex in the water at the entrance.

**APPLICANT** - A person, Limited Liability Partnership, Corporation, etc. applying for a plan approval or permit. It also includes any consultant, attorney or agent who is submitting on their behalf.

**APRON** - A lining to protect a surface from erosion (e.g., the area below culverts or spillways).

**AQUATIC BENCH** - A bench which is located around the inside perimeter of a permanent pool and is normally vegetated with aquatic plants; the goal is to provide pollutant removal and enhance safety in areas using storm water pond BMPs.

**AQUIFER** - A porous water bearing geologic formation generally restricted to materials capable of yielding an appreciable supply of water.

**AS-BUILT** - Drawing or certification of conditions as they were actually constructed.

**BAFFLE** - Guides, grids, grating or similar devices placed in a pond to deflect or regulate flow and create a longer flow path.

**BANKFULL FLOW** - The condition where stream flow fills a stream channel to the top of the bank and at a point where the water begins to overflow onto a floodplain.

**BARREL** - The closed conduit used to convey water under or through an embankment; part of the principal spillway.

**BASE FLOW** - The stream discharge from groundwater contribution.

**BERM** - A shelf that breaks the continuity of a slope; a linear embankment or dike.

**BEST MANAGEMENT PRACTICE (BMP)** - A structural or non-structural device designed to temporarily store or treat storm water runoff in order to mitigate flooding, reduce pollution and provide other amenities.

**BIORETENTION** - A water quality practice that utilizes landscaping and soils to treat urban storm water runoff by collecting it in shallow depressions before filtering through a fabricated planting soil media.

**BUFFER** - Zone of variable width located along both sides of a natural feature (e.g., stream or forested area) and designed to provide a protective area along a corridor.

**CHANNEL** - An open drainage conveyance of either man-made or natural stream that conveys water; a ditch or channel excavated for the flow of water.

**CHANNEL PROTECTION VOLUME (CP<sub>v</sub>)** - A design criteria which requires 24-hour detention of the one year post-developed, 24-hour storm event for the control of stream channel erosion and is calculated according to Appendix D.11.

**CHANNEL STABILIZATION** - Erosion prevention and stabilization of velocity distribution in a channel using jetties, drops, revetments, structural linings, vegetation and other measures.

**CHECK DAM** - A small dam constructed in a gully or other small watercourse to decrease flow velocity (by reducing the channel gradient), minimize scour, and promote deposition of sediment.

**CHUTE** - A high-velocity, open channel for conveying water to a lower level without erosion.

**CLAY (SOILS)** - 1. A mineral soil consisting of particles less than 0.002 millimeter in equivalent diameter. 2. A soil texture class. 3. (Engineering) A fine grained soil (more than 50 % passing the No. 200 sieve) that has a high plasticity index in relation to the liquid limit. (Unified Soil Classification System)

**CLEAR** - To remove the vegetative cover while leaving the root mat intact.

## GLOSSARY

Issue Date: September 30, 2014

COCONUT ROLLS - Also known as coir rolls, these are rolls of natural coconut fiber designed to be used for stream bank stabilization.

COFFERDAM - A barrier or device used to prevent water from entering a work area.

COMPACTION (SOILS) - Any process by which the soil grains are rearranged to decrease void space and bring them in closer contact with one another, thereby increasing the weight of solid material per unit of volume, increasing the shear and bearing strength and reducing permeability. (2) The process of uniting firmly. With respect to construction work with soils, compaction is any process by which the soil grains are rearranged to decrease void space and bring them into closer contact with one another, thereby increasing weight of soil material per unit of volume, increasing the shear and bearing strength, and reducing permeability.

CONDUIT - Any channel intended for the conveyance of water, whether open or closed pipe.

CONCENTRATED FLOWS - Water, usually storm water runoff that converges in well-defined channels, ditches, gullies, streams, or pipes.

CONTOUR - 1. An imaginary line on the surface of the earth connecting points of the same elevation. 2. An imaginary line drawn on a map connecting points of the same elevation.

CONVEYANCE -

CORE TRENCH - A trench, filled with relatively impervious material intended to reduce seepage of water through porous strata.

CRADLE - A structure usually of concrete shaped to fit around the bottom and sides of a conduit to support the conduit, increase its strength and, in dams, to fill all voids between the underside of the conduit and the soil.

CREST - 1. The top of a dam, dike, spillway or weir, frequently restricted to the overflow portion. 2. The summit of a wave or peak of a flood.

CRUSHED STONE - Aggregate consisting of angular particles produced by mechanically crushing rock.

CULTIPACKER SEEDER - A tool equipped with a seed box that drops the seed between rollers to place the seed on firm soil where it is pressed into soil by the second corrugated roller.

CURVE NUMBER (CN) - A numerical representation of a given area's hydrologic soil group, plant cover, impervious cover, interception and surface storage derived in

accordance with Natural Resources Conservation Service methods. This number is used to convert rainfall depth into runoff volume.

CUT - Portion of land surface or area from which earth has been removed or will be removed by excavation; the depth below original ground surface to excavated surface.

CUT-AND-FILL - Process of earth moving by excavating part of an area and using the excavated material for adjacent embankments or fill areas.

CUTOFF - A wall or other structure, such as a trench, filled with relatively impervious material intended to reduce seepage of water through porous strata.

CUTOFF TRENCH - An excavation below an embankment filled with relatively impervious material intended to reduce seepage of water through porous strata.

CZARA - Acronym used for the Coastal Zone Act Reauthorization Amendments of 1990. These amendments sought to address the nonpoint source pollution issue by requiring states to develop coastal nonpoint pollution control programs in order to receive federal funds.

DAM - A barrier to confine or raise water for storage or diversion, to create a hydraulic head, to prevent gully erosion, or for retention of soil, sediment or other debris.

DEPOSITION - The accumulation of settled material due to reduced movement of the transporting agent (e.g., water or wind, ice or gravity).

DETENTION - The temporary storage of storm water runoff in a BMP with the goals of controlling peak discharge rates and providing gravity settling of pollutants.

DETENTION STRUCTURE - A permanent structure for the temporary storage of runoff that is designed to not create a permanent pool of water.

DIKE - An embankment to confine or control water, for example, one built along the banks of a river to prevent overflow to lowlands; a levee.

DISTRIBUTED RUNOFF CONTROL (DRC) - A stream channel protection criteria which utilizes a non-uniform distribution of the storage-stage-discharge relationship within a BMP to minimize the change in channel erosion potential from pre-developed to developed conditions.

DISTURBED AREA - An area in which the natural vegetative soil cover has been removed or altered and, therefore, is susceptible to erosion.

DIVERSION - A channel with a supporting ridge on the lower side constructed across the slope to divert water to areas where it can be used or disposed of safely. Diversions differ from terraces in that they are individually designed.

## GLOSSARY

Issue Date: September 30, 2014

**DRAINAGE** - 1. The removal of excess surface water or ground water from land by means of surface or subsurface drains. 2. Soil characteristics that affect natural drainage.

**DRAINAGE AREA (WATERSHED)** - That area contributing runoff to a single point measured in a horizontal plane, which is enclosed by a ridge line.

**DROP STRUCTURE** - A structure for dropping water to a lower level and dissipating surplus energy; a fall.

**DRY SWALE** - An open drainage channel explicitly designed to detain and promote the filtration of storm water runoff through an underlying fabricated soil media.

**EMERGENCY SPILLWAY** - A dam spillway, constructed in natural ground, that is to discharge flow in excess of the principal spillway design discharge.

**ENERGY DISSIPATOR** - A designed device such as an apron of riprap or a concrete structure placed at the end of a conduit for the purpose of reducing the velocity, energy and turbulence of the discharged water.

**EROSION** - 1. The process by which the land surface is worn away by the action of water, wind, ice, or gravity. 2. Detachment and movement of soil or rock fragments by water, wind, ice or gravity. The following terms are used to describe different types of water erosion:

**ACCELERATED EROSION** - Erosion much more rapid than normal, natural or geologic erosion, primarily as a result of the influence of the activities of man or, in some cases, of other animals or natural catastrophes that expose base surfaces.

**GULLY EROSION** - The erosion process whereby water accumulates in narrow channels and removes the soil from this narrow area to considerable depths ranging from 1 or 2 feet to as much as 75 to 100 feet.

**RILL EROSION** - An erosion process in which numerous small channels only several inches deep are formed.

**SHEET** - The spattering of small soil particles caused by the impact of raindrops on wet soils. The loosened and spattered particles may or may not subsequently be removed by surface runoff.

**EROSIVE VELOCITIES** - Velocities of water that are high enough to wear away the land surface. Exposed soil will generally erode faster than stabilized soils. Erosive velocities will vary based on flow and according to the soil type, slope, and structural or vegetative stabilization used to protect the soil.

**EXFILTRATION** - The downward movement of water through the soil; the downward flow of runoff from the bottom of an infiltration BMP into the soil.

**EXTENDED DETENTION** - A storm water design feature that provides for the gradual release of a volume of water in order to increase settling of pollutants and protect downstream channels from frequent storm events.

**EXTREME FLOOD VOLUME (Q<sub>f</sub>)** - The storage volume required to control those infrequent but large storm events in which overbank flows reach or exceed the boundaries of the 100-year floodplain.

**FILTER BED** - The section of a constructed filtration device that houses the filter media and the outflow pipe.

**FILTER MEDIA** - The sand, soil, or other organic material in a filtration device used to provide a permeable surface for pollutant and sediment removal.

**FILTER STRIP** - A strip of permanent vegetation above ponds, diversions and other structures to retard the flow of runoff, causing deposition of transported material, thereby reducing sedimentation.

**FINES (SOIL)** - Generally refers to the silt and clay size particles in soil.

**FLOODPLAIN** - Areas adjacent to a stream or river that are subject to flooding or inundation during a storm event that occurs, on average, once every 100 years (or has a likelihood of occurrence of 1/100 in any given year).

**FLOW SPLITTER** - An engineered, hydraulic structure designed to divert a percentage of storm flow to a BMP located out of the primary channel, or to direct storm water to a parallel pipe system or to bypass a portion of base flow around a BMP.

**FOREBAY** - Storage space located near a storm water BMP inlet that serves to trap incoming coarse sediments before they accumulate in the main treatment area.

**FREEBOARD (HYDRAULICS)** - The distance between the maximum WSEL anticipated in design and the top of retaining banks or structures. Freeboard is provided to prevent overtopping due to unforeseen conditions.

**FRENCH DRAIN** - A type of drain consisting of an excavated trench filled with pervious material, such as coarse sand, gravel or crushed stone; water percolates through the voids in this material and flows to an outlet.

**FUNCTIONAL MAINTENANCE:** Functional maintenance of drainage and storm water management systems shall include mowing of grass once a year, removal of debris or sediment build up that results in clogging or loss of function, life cycle maintenance including replacement of pipes, structures, clogged filters, damaged or inoperable

## GLOSSARY

Issue Date: September 30, 2014

valves, stairs, trash racks and other appurtenances, and repair to the structural integrity of earthen embankments, outfalls and access roads.

**GABION** - A flexible woven wire basket composed of rectangular cells filled with small or medium size stones. Gabions may be assembled into many types of structures such as revetments, retaining walls, channel liners, drop structures and groins.

**GABION MATTRESS** - A thin gabion, usually 6 or 9 or 12 inches thick, used to line channels for erosion control.

**GRADE** - To disturb earth by, including but not limited to, any excavation, filling, stockpiling, grubbing, removing root mat or topsoil, or any combination thereof. The slope or finished surface of a road, channel, canal bed, roadbed, top of embankment, bottom of excavation, or natural ground; any surface prepared for the support of construction, like paving or laying a conduit. 2. To finish the surface of a canal bed, roadbed, top of embankment or bottom of excavation.

**GRADING UNIT** - The maximum contiguous area of disturbed earth on site allowed to be graded at a given time. Limited to 20 acres or less.

**GRASS CHANNEL** - An open vegetated channel used to convey runoff and to provide treatment by filtering pollutants and sediments.

**GRAVEL** - 1. Aggregate consisting of mixed sizes of 1/4 inch to 3 inches which normally occur in or near old streambeds and have been worn smooth by the action of water. 2. A soil having particle sizes, according to the Unified Soil Classification System, ranging from the No. 4 sieve size, angular in shape, as produced by mechanical crushing.

**GRAVEL DIAPHRAGM** - A stone trench filled with small, river-run gravel used as pretreatment and inflow regulation in storm water filtering systems.

**GRAVEL FILTER** - Washed and graded sand and gravel aggregate placed around a drain or well screen to prevent the movement of fine materials from the aquifer into the drain or well.

**GRAVEL TRENCH** - A shallow excavated channel backfilled with gravel and designed to provide temporary storage and permit percolation of runoff into the soil substrate.

**GROUND COVER** - Plants that are low-growing and provide a thick growth which protects the soil as well as provides some beautification of the area occupied.

**GULLY** - A channel or miniature valley cut by concentrated runoff through which water commonly flows during and immediately after heavy rains or snow melt. The distinction between gully and rill is one of depth. A gully is sufficiently deep such that it would not be obliterated by normal tillage operations, whereas a rill is of lesser depth and would be smoothed by ordinary farm tillage or grading activities.

## **GLOSSARY**

**Issue Date: September 30, 2014**



**HEAD (HYDRAULICS)** - 1. The height of water above any plane of reference. 2. The energy, either kinetic or potential, possessed by each unit weight of a liquid expressed as the vertical height through which a unit weight would have to fall to release the average energy possessed. Used in various terms such as pressure head, velocity head, and head loss.

**HERBACEOUS PERENNIAL (PLANTS)** - A plant whose stems die back to the ground each year.

**HIGHLY ERODIBLE SOILS** - Soils with slopes greater than 15% or soils with a K Value greater than 0.35 and with slopes greater than 5%.

**HIGH MARSH** - A pondscaping zone within a storm water wetland that exists from the surface of the normal pool to a 6-inch depth and typically contains the greatest density and diversity of emergent wetland plants.

**HIGH MARSH WEDGES** - Slices of shallow wetland (less than or equal to 6 inches) dividing a storm water wetland.

**HOTSPOT** - Area where land use or activities generate highly contaminated runoff, with concentrations of pollutants in excess of those typically found in storm water.

**HYDRAULIC GRADIENT** - The slope of the hydraulic grade line. That includes static and potential head.

**HYDRODYNAMIC STRUCTURE** - An engineered structure to separate sediments and oils from storm water runoff using gravitational separation and/or hydraulic flow.

**HYDROGRAPH** - A graph showing variation in stage (depth) or discharge of a stream of water over a period of time.

**HYDROLOGIC SOIL GROUP (HSG)** - A Natural Resource Conservation Service classification system in which soils are categorized into four runoff potential groups. The groups range from A soils, with high permeability and little runoff production, to D soils, which have low permeability rates and produce much more runoff.

**HYDROSEED** - An application of seed or other material applied with forced water in order to revegetate.

**HYDROSEEDER** - A machine for applying seed, fertilizer, lime, short fiber wood, or paper mulch to the soil surface.

**IMPERVIOUS CORE** - Area within an embankment consisting of dense soils with a clay component intended to reduce seepage of water through porous strata.

**IMPERVIOUS COVER (I)** - Those surfaces in the landscape that cannot infiltrate rainfall consisting of building rooftops, pavement, sidewalks, driveways, gravel areas, etc.

**INDUSTRIAL STORMWATER PERMIT** - An NPDES permit issued to an identified land use that regulates the pollutant levels associated with industrial storm water discharges or specifies onsite pollution control strategies.

**INFILTRATION RATE ( $f$ )** - The rate at which storm water percolates into the subsoil measured in inches per hour.

**INFLOW PROTECTION** - A water handling device used to protect the transition area between any water conveyance (dike, swale, or swale dike) and a sediment trapping device.

**LIME** - Basic calcareous materials used to raise pH of acid soils for benefit of plants being grown. May be ground limestone or hydrated lime.

**LEVEL SPREADER** - A device for distributing storm water uniformly over the ground surface as sheet flow to prevent concentrated, erosive flows and promote infiltration.

**MANNING'S FORMULA (HYDRAULICS)** - A formula used to predict the velocity of water flow in an open channel or pipeline: Where  $V$  is the mean velocity of flow in feet per second;  $r$  is the hydraulic radius;  $s$  is the slope of the energy gradient or for assumed uniform flow the slope of the channel, in feet per foot; and  $n$  is the roughness coefficient or retardance factor of the channel lining.

**MICROPOOL** - A smaller permanent pool which is incorporated into the design of larger storm water ponds to avoid resuspension of particles and minimize impacts to adjacent natural features.

**MICROTOPOGRAPHY** - The complex contours along the bottom of a shallow wetland system, providing greater depth variation that increases the wetland plant diversity and increases the surface area to volume ratio.

**MULCH** - Covering on the soil surface to protect and enhance certain characteristics, such as water retention qualities.

**MUNICIPAL STORMWATER PERMIT** - An NPDES permit issued to municipalities to regulate discharges from municipal separate storm sewers for compliance with EPA regulations.

**NON-STRUCTURAL BMPs** - Stormwater runoff treatment techniques which use natural measures to reduce pollution levels, do not require extensive construction efforts and/or promote pollutant reduction by eliminating the pollutant source.

**NITROGEN-FIXING (BACTERIA)** - Bacteria having the ability to fix atmospheric nitrogen, making it available for use by plants. (2) Bacteria having the ability to combine nitrogen with oxygen or hydrogen to create compounds that are usable by plants. Inoculation of legume seeds is one way to ensure a source of these bacteria for specified legumes.

**NON-EROSIVE VELOCITY** - A sufficiently low velocity of water to prevent detachment and movement of soil or rock.

**NORMAL DEPTH** - Depth of flow in an open conduit during uniform flow for any given conditions.

**NPDES** - Acronym for the National Pollutant Discharge Elimination System, which regulates point source discharges.

**OFF-LINE** - A management system designed to control a storm event by diverting a percentage of storm water events from a stream or storm drainage system.

**ON-LINE** - A management system designed to control storm water in its original stream or drainage channel.

**ONE-YEAR STORM** - A storm water event which occurs on average once every year or statistically has a 100% chance on average of occurring in a given year.

**ONE HUNDRED YEAR STORM** - An extreme flood event which occurs on average once every 100 years or statistically has a 1% chance on average of occurring in a given year.

**OPEN CHANNEL** - Also known as swale, grass channel, and bio filter. This system is used for the conveyance, retention, infiltration and filtration of storm water runoff.

**OUTFALL** - The point where water discharges from a conduit, stream, or drain.

**OUTLET** - The point at which water discharges from such things as a stream, river, lake, tidal basin, pipe, channel or drainage area.

**OUTLET CHANNEL** - A waterway constructed or altered primarily to carry water from manmade structures such as terraces, subsurface drains, diversions and impoundments.

**OVERBANK FLOOD PROTECTION VOLUME ( $Q_p$ )** - The volume controlled by structural practices to prevent an increase in the frequency of out of bank flooding generated by development.

**PEAK DISCHARGE RATE** - The maximum instantaneous rate of flow during a storm, usually in reference to a specific design storm event.

**PERCENT AREA METHOD** - Technique used to evaluate the compliance of a non-structural BMP for meeting recharge requirements by calculating the percent of impervious area effectively treated and comparing to a minimum recharge target percentage for the various soil groups.

**PERCENT VOLUME METHOD** - Procedure used with structural BMPs to evaluate compliance with recharge requirements by assuring that the volume of runoff treated by the practice exceeds the computed recharge volume.

**PERMANENT SEEDING** - The establishment of perennial vegetation which may remain for many years.

**PERMEABILITY** - The rate of water movement through a soil column under saturated conditions.

**PERMEABLE COVER** - Those surfaces in the landscape consisting of open space, forested areas, meadows, etc. that infiltrate rainfall.

**PERMISSIBLE VELOCITY (HYDRAULICS)** - The highest average velocity at which water may be carried safely in a channel or other conduit. The highest velocity that can exist through a substantial length of a conduit and not cause scour of the channel. A safe, non-eroding or allowable velocity

**pH** - A number denoting the common logarithm of the reciprocal of the hydrogen ion concentration. A pH of 7.0 denotes neutrality, higher values indicate alkalinity, and lower values indicate acidity.

**pH** - A number denoting the common logarithm of the reciprocal of the hydrogen ion concentration. A value of 7.0 denotes neutrality; higher values indicate alkalinity; and lower values indicate acidity.

**PHASING** - Sequential progression of site development activities during construction.

**PHREATIC LINE** - The demarcation of the saturation zone within an embankment.

**PIPING** - Removal of soil material through subsurface flow channels.

**PLUGS** - Pieces of turf or sod, usually cut with a round tube, which can be used to propagate the turf or sod by vegetative means.

**POCKET POND** - A storm water pond designed for treatment of small drainage area (< 5 acres) runoff and which has little or no base flow available to maintain water elevations and relies on groundwater to maintain a permanent pool.

**POCKET WETLAND** - A storm water wetland design adapted for the treatment of runoff from small drainage areas (< 5 acres) and which has little or no base flow available to maintain water elevations and relies on groundwater to maintain a permanent pool.

## GLOSSARY

Issue Date: September 30, 2014

POND BUFFER - The area immediately surrounding a pond which acts as a filter to remove pollutants and provide infiltration of storm water prior to reaching the pond. Provides a separation barrier to adjacent development.

POND DRAIN - A pipe or other structure used to drain a permanent pool within a specified time period.

PONDSCAPING - Landscaping around storm water ponds which emphasizes using native vegetative species to meet specific design intentions. Species are selected for up to six zones in the pond and its surrounding buffer based on their ability to tolerate inundation and/ or soil saturation.

POROSITY ( $n$ ) - Ratio of pore volume to total volume.

PRETREATMENT - Techniques employed in storm water BMPs to provide storage or filtering to help trap coarse materials and other pollutants before they enter the system.

PREDEVELOPED - For non-forested vegetated areas including agriculture, meadow in good condition shall be used.

PRINCIPAL SPILLWAY - The primary pipe or weir which carries base flow and storm flow through a dam embankment.

RECHARGE RATE - Annual amount of rainfall which contributes to groundwater as a function of hydrologic soil group.

RECHARGE VOLUME (Rev) - The portion of the water quality volume (WQv) used to maintain groundwater recharge rates at development sites.

RECYCLED CONCRETE EQUIVALENT - Cementitious material that is broken into the stone sizes required for the application, angular, resistant to crumbling, and contains no steel reinforcement. May be substituted for stone except in permanent applications or where stone must be "washed."

REDEVELOPMENT - Any construction, alteration, or improvement exceeding 5,000 square feet of land disturbance performed on sites where existing land use is commercial, industrial, institutional, or multifamily residential.

RETENTION - The amount of precipitation on a drainage area that does not escape as runoff. It is the difference between total precipitation and total runoff.

REVERSE-SLOPE PIPE - A pipe which draws from below a permanent pool extending in a reverse angle up to the riser and determines the water elevation of the permanent pool.

## GLOSSARY

Issue Date: September 30, 2014

**RIGHT-OF-WAY** - Right of passage, as over another's property. A route that is lawful to use. A strip of land acquired for transport, conveyance or utility construction.

**RIPRAP** - Broken rock, cobbles, or boulders placed on earth surfaces, such as the face of a dam or the bank of a stream, for protection against the action of water (waves); also applies to brush or pole mattresses or brush and stone, or similar materials used for soil erosion control.

**RISER** - A vertical pipe or structure which extends from the bottom of a pond and houses the control devices (weirs/orifices) to achieve the discharge rates for specified designs.

**ROUGHNESS COEFFICIENT (HYDRAULICS)** - A factor in velocity and discharge formulas representing the effect of channel roughness on energy losses in flowing water. Manning's "n" is a commonly used roughness coefficient.

**RUNOFF (HYDRAULICS)** - That portion of the precipitation on a drainage area that is discharged from the area in the stream channels. Types include surface runoff, groundwater runoff, or seepage.

**SAFETY BENCH** - A relatively flat area above the permanent pool and surrounding a storm water pond designed to provide a separation to adjacent slopes.

**SAND** - 1. (Agronomy) A soil particle between 0.05 and 2.0 millimeters in diameter. 2. A soil textural class. 3. (Engineering) According to the Unified Soil Classification System, a soil particle larger than the No. 200 sieve (0.074 mm) and passing the No. 4 sieve (approximately 1/4 inch).

**SEDIMENT** - Soils or other surficial materials transported or deposited by the action of wind, water, ice, or gravity as a product of erosion.

**SEEPAGE** - 1. Water escaping through or emerging from the ground. 2. The process by which water percolates through soil.

**SEEPAGE LENGTH** - In sediment basins or ponds, the length along the pipe and around the antiseep collars that is within the zone of saturation through an embankment.

**SETBACKS** - The minimum distance requirements for locating certain structures in relation to roads, wells, septic fields, or other structures.

**SHEET FLOW** - Water, usually storm runoff, flowing in a thin layer over the ground surface.

**SIDE SLOPES (ENGINEERING)** - The slope of the sides of a channel, dam or embankment. It is customary to name the horizontal distance first, as 1.5 to 1, or frequently, 1 ½: 1, meaning a horizontal distance of 1.5 feet to 1 foot vertical.

**SILT** - 1. (Agronomy) A soil separate consisting of particles between 0.05 and 0.002 millimeter in equivalent diameter. 2. A soil textural class. 3. (Engineering) According to the Unified Soil Classification System a fine grained soil (more than 50 percent passing the No. 200 sieve) that has a low plasticity index in relation to the liquid limit.

**SILT FENCE** - A geotextile fabric designed to trap sediment and filter runoff.

**SLURRY** - A thickened, aqueous mixture of such things as seed, fertilizer, short fiber mulch or soil.

**SOD** - An area of grass covered soils held together by matted roots; turf.

**SOIL TEST** - 1. Physical analysis of soil properties such as grain size, plasticity, or texture. 2. Chemical analysis of soil to determine the need for fertilizers or amendments for species of plant being grown.

**SOIL TEXTURE** - The relative proportions of various sized soil particles.

**SPILLWAY** - An open or closed channel, or both, used to convey excess water from a reservoir. It may contain gates, either manually or automatically controlled to regulate the discharge of excess water.

**STABILIZE** - To protect exposed soils from erosion by the application of seed and mulch, seed and matting, sod, other vegetative measure, and/or structural means.

**STABILIZATION** - Providing vegetative and/or structural measures that will reduce or prevent erosion.

**STABLE AREA** - An area sufficiently covered by erosion- resistant material, such as good cover of grass or paving by asphalt, concrete, or stone, that erosion of the underlying soil does not occur.

**STAGE (HYDRAULICS)** - The variable water surface or the WSEL above any chosen datum.

**STILLING BASIN** - An open structure or excavation at the foot of an outfall, conduit, chute, drop, or spillway to reduce the energy of the descending stream of water.

**STORMWATER FILTERING** - Stormwater treatment methods which utilize an artificial media to filter out pollutants entrained in urban runoff.

**STORMWATER PONDS** - A land depression or impoundment created for the detention or retention of storm water runoff.

**STORMWATER WETLANDS** - Shallow, constructed pools that capture storm water and allow for the growth of characteristic wetland vegetation.

**STREAM BUFFERS** - Zones of variable width which are located along both sides of a stream and are designed to provide a protective natural area along a stream corridor.

**STRUCTURAL BMPs** - Devices which are constructed to provide temporary storage and treatment of storm water runoff.

**STRUCTURAL (SOIL)** - The combination or arrangement of primary soil particles into secondary particles, units, or peds.

**SUBGRADE** - The soil prepared and compacted to support a structure or a pavement system, or prepared to provide infiltration.

**TAILWATER** - Water, in a river or channel, immediately downstream from a structure.

**TECHNICAL RELEASE No. 20 (TR-20)** - A Soil Conservation Service (now NRCS) watershed hydrology computer model that is used to compute runoff volumes and provide routing of storm events through stream valleys and/or ponds.

**TECHNICAL RELEASE No. 55 (TR-55)** - A watershed hydrology model developed by the Soil Conservation Service (now NRCS) used to calculate runoff volumes and provide a simplified routing for storm events through stream valleys and/or ponds.

**TEMPORARY SEEDING** - A seeding which is made to provide temporary cover for the soil while waiting for further construction or other activity to take place.

**TEN-YEAR STORM** - The 24-hour storm event that exceeds bank full capacity and occurs on average once every ten years (or has a likelihood of occurrence of 1/10 in a given year).

**TIER II WATERS** - Tier II waters are "high quality waters" as listed in COMAR 26.08.02.04-1.

**TIME OF CONCENTRATION ( $T_c$ )** - Time required for water to flow from the most remote point of a watershed, in a hydraulic sense, to the outlet.

**TOE OF SLOPE** - Where the slope stops or levels out. Bottom of the slope.

**TOE WALL** - Downstream wall of a structure, usually to prevent flowing water from eroding under the structure.

## GLOSSARY

Issue Date: September 30, 2014



TOPSOIL - Fertile or desirable soil material used to top dress road banks, subsoil, and parent materials.

TOTAL PHOSPHORUS (TP) - The total amount of phosphorus that is contained within the water column.

TOTAL SUSPENDED SOLIDS (TSS) - The total amount of particulate matter that is suspended in the water column.

TRASH RACK - A vertically extended grill, grate or other device at the intake of a channel, pipe, drain or spillway for the purpose of preventing oversized debris from entering the structure.

TRUNCATED HYDROGRAPH - A method of computing the required design infiltration storage volume utilizing the differences from post-developed and pre-developed hydrograph volumes over a specific timeframe.

TWO-YEAR STORM - The 24-hour storm event which exceeds bank full capacity and occurs on average once every two years (or has a likelihood of occurrence of 1/2 in a given year).

ULTIMATE CONDITION - Full watershed build-out based on existing zoning.

ULTRA-URBAN - Densely developed urban areas in which little pervious surface exists.

UNIFIED SOIL CLASSIFICATION SYSTEM - A classification system based on the identification of soils according to their particle size, gradation, plasticity index, and liquid limit.

VELOCITY HEAD - Head due to the velocity of a moving fluid, equal to the square of the mean velocity divided by twice the acceleration due to gravity (32.16 feet per second per second)[  $V^2/2g$ ].

VOLUMETRIC RUNOFF COEFFICIENT ( $R_v$ ) - The value that is applied to a given rainfall volume to yield a corresponding runoff volume based on the percent impervious cover in a drainage basin.

WATER QUALITY VOLUME (WQV) - The volume needed to capture and treat 90% of the average annual storm water runoff volume equal to 1 inch (or 0.9 inch in Western Rainfall Zone) times the volumetric runoff coefficient ( $R_v$ ) times the site area.

WATER SURFACE PROFILE - The longitudinal profile assumed by the surface of a stream flowing in an open channel; the hydraulic grade line.

**WATER USE DESIGNATION** - State of Maryland water use classification for the protection of resources (i.e., Use I-contact recreational use, Use II-shellfish harvest waters, Use III-natural trout waters, Use IV-recreational trout waters).

**WEDGES** - Design feature in storm water wetlands that increases flow path length to provide for extended detention and treatment of runoff.

**WET SWALE** - An open drainage channel or depression, explicitly designed to retain water or intercept groundwater for water quality treatment.

**WETTED PERIMETER** - The length of the wetted surface of the channel.

**WING WALL** - Side wall extensions of a structure used to prevent sloughing of banks or channels.

This Page Intentionally Left Blank