



Prince George's County  
Department of  
Public Works and Transportation



EXHIBIT A

Angela D.  
Alsobrooks  
~~Rushern L. Baker, III~~  
County Executive

Michael Johnson  
~~Darrell B. Mobley~~  
Director

# URBAN Street Design STANDARDS

[AUGUST 2017] JULY 2023



## Table of Contents

Overview .....	3
Vision .....	3
Background and Supporting Documents .....	3
Use of the Urban Street Design Standards.....	4
Development of the New Urban Street Standards .....	4
New Urban Street Typologies .....	5
Summary of Existing Standards and Urban Street Standards .....	14
Appendix A: Urban Street Design Standards.....	15
Appendix B: Additional Design Considerations... ..	35

## Overview

This document presents Urban Street Design Standards for use in Prince George's Regional Transit Districts and Local Centers for approval by the County Executive and Council. These new standards were developed by Prince George's Department of Public Works and Transportation (DPW&T) in collaboration with other departments that play a role in the planning, development, construction and maintenance of streets and adjacent land uses in the County.

## Vision

Streets are the backbone of the urban environment and as such they must accommodate the needs of all users. Complete Streets increase all users' sense that safety and comfort, help businesses and economic centers thrive, and contribute to an overall sense of place and community. As designated Transit Districts and Local Centers in Prince George's County transform from suburban-style development with automobile-focused roadways to urban centers focused on increased transit, walking, and bicycling, well-balanced street design will be more important than ever. The urban standards presented here aim to ensure that all public streets, including privately constructed streets approved by the County as well as publicly funded projects, are Complete Streets which are safe, comfortable, and inviting to all users.

## Background and Supporting Documents

A number of County policies and principles support and drive the design intent of the new urban street standards. In 2012, Prince George's County adopted a Complete and Green Streets Policy (CB-83-2012) that stated:

*"...All planned County financed and approved road, sidewalk, trail and transit related construction and reconstruction projects shall include environmental site design and facilities for the combined use of motor, emergency and freight vehicles, transit, bicycles and pedestrians, except when cost shall be disproportionate to the projected need or when such facilities would be inappropriate due to the nature of the project, including the context and character of the surrounding built and natural environment of the neighborhood or area."*

In October 2015, the Prince George's County Council passed CB-86-2015 calling for the development of new urban street standards. In November 2016, the Council approved CR-085-2016, which contained specifications and standards for Regional Transit Districts and Local Centers. With this legislation, the County adopted "an urban street design policy and principles, consistent with the Council's 2014 approval of its most current general plan for the County, *Plan Prince George's 2035*." *Plan 2035* established the following important strategy, among others, to become more multimodal and better align transportation with the adjacent land use context:

*"Design all capital road improvements and streetscape enhancements and all new development in the Regional Transit Districts, the Innovation Corridor, and Local Centers, to improve multimodal travel for pedestrians, cyclists, transit and other alternatives to the automobile. The primary transportation improvements in these areas should be focused on pedestrian and bicyclist facilities and public transit upgrades and retrofits."*

The Urban Street Standards presented here align DPW&T's design requirements with the intent of the policies and legislation above. They were developed based on best practices in the metropolitan DC region and across the nation.

### Use of the Urban Street Design Standards

As stated in CB-86-2015 and CR-085-2016, the new Urban Street Design Standards are intended for use in designing new and retrofit streets in Regional Transit Districts and Local Centers, as established by *Plan Prince George's 2035*. *Plan 2035* identified eight Regional Transit Districts that have the necessary transit and transportation infrastructure to support future growth as mixed use centers. The majority of future employment and residential growth is to be directed to the Regional Transit Districts and *Plan 2035* envisions high quality urban design and multimodal transportation in these areas.

*Plan 2035* also designates 26 Local Centers, including new Purple Line stations, as focal points for development based on their access to transit or major highways. The Plan envisions these centers to be walkable, particularly in their cores and where transit is available.

### Development of the New Urban Street Standards

In order to ensure the new Urban Street Design Standards adequately address the concerns of multiple County departments and align with the complete streets policies cited above, the Department of Public Works and Transportation (DPW&T) established a committee of representatives from various departments to develop the new urban standards. Consultants with expertise in developing Complete Streets design standards for jurisdictions in the DC region and throughout the U.S. provided assistance to the committee. Staff from the following departments participated in the committee:

- County Executive's Office (CEX)
- DPW&T (Office of the Director, Office of Engineering & Project Management, Office of Transportation, and Office of Highway Maintenance)
- Department of Permitting, Inspections & Enforcement
- Department of the Environment (DOE) (Stormwater Management Division)
- Maryland-National Capital Park and Planning Commission (M-NCPPC) (Transportation Planning and Community Planning)

The members of this committee held work sessions over a period of several months to arrive at consensus on key topics related to urban street design. Each of the work sessions included a presentation regarding best practices led by an expert in multimodal street design. The sessions also included facilitated discussions regarding how to best apply these practices in Prince George's Urban Street Design Standards. The work session discussion topics included:

- New urban street typologies to supplement suburban-style functional street classifications
- Street designs that achieve desired motor vehicle speeds (including sessions on target design speeds and appropriate travel lane widths)
- Designs that improve conditions for pedestrians, including intersection design to improve pedestrian safety and comfort (including a session on designing street corner radii to produce slower turning speeds)
- Street designs that facilitate stormwater management
- Street designs that improve conditions for bicyclists



The committee agreed that, in order to better balance the needs of pedestrians, bicyclists, transit users and vehicles, it is critical to incorporate the following key elements into the Urban Street Design Standards:

- Slower speeds
- Shorter crossing distances
- Reduced curb radii
- Wider sidewalks
- More bicycle facilities
- Pedestrian amenities

### New Urban Street Typologies

Traditionally in Prince George's County, the functional classification of a particular roadway has determined the basic design of the street. Arterials, collectors and local streets have typically been designed to accommodate the anticipated volume of vehicle traffic and desired level of service with less attention paid to the land use context of the roadway. To facilitate a better balance between functional classification, adjacent land uses and the competing needs of various users of the transportation system, DPW&T and the steering committee agreed to establish new street typologies for urban streets, including:

- Mixed Use Boulevard (2, 3, and 4 lane options), and transit priority design standards,
- Neighborhood Connector
- Neighborhood Residential
- Industrial Road
- Shared Street
- Alley

These typologies do not replace the functional classification of the roadway, but should be used as an overlay to better design streets for existing, future and desired land uses, the needs of multiple roadway users, and to encourage the use of walking, bicycling, and transit. The following section describes each of the new urban street types and provides an illustration of a typical cross-section established by the new street design standards. A summary table, with typical dimensions and other characteristics for each street type, is included at the end of this section. The Urban Street Design Standard details are presented in the next section of this document. The street typologies and standards reinforce the policies and principles in *Plan 2035* and various small area plans and are consistent with CB-86-2015 and CR-085-2016. They contain elements and dimensions that encourage multimodal use of the roadway: slower design speeds, fewer travel lanes, wider sidewalks, greater bicycle accommodation and shorter crossing distances.

#### Notes:

- A) These standards shall be incorporated into [should be read in conjunction with] the existing Prince George's County Specifications and Standards for Roads and Bridges (revision 03/14/12).
- B) Several of the street types that follow include two variations: Option A, which includes a separated bike lane, and Option B, which does not. Option A is the preferred scenario and Option B is provided as an alternative for retrofit conditions or other cases where right-of-way is particularly constrained.

*Mixed-Use Boulevard*

Mixed-Use Boulevards are significant roadways that travel through the heart of medium- to high-density mixed-use centers. Buildings along Mixed-Use Boulevards are located close to the street. Mixed-use Boulevards experience heavy transit, pedestrian and bicycle activity and, as such, require slow vehicular speeds, wide sidewalks and short crossings to ensure the safety of all users. Separated bike lanes are recommended on this type of roadway unless traffic volumes are extremely low. Example cross sections are shown on the following pages and additional information is provided in the standard details. ~~[No more than the maximum number of travel lanes -- 2, 3 or 4 -- required to maintain LOS E based on most recent published traffic volumes (ADT and AADT) shall be used. Mixed Use Boulevard (2, 3, and 4 lane options) shall be the urban street typologies used for arterials and collector roads.]~~

Street Type	Description	Typical Features
Mixed Use Boulevard	<ul style="list-style-type: none"> <li>• Buildings close to street</li> <li>• Mix of land uses</li> <li>• Medium- to high-density land use</li> <li>• High volumes of vehicles and transit</li> <li>• Medium to heavy pedestrian/bike activity</li> <li>• Slow speeds (25 mph)</li> </ul>	<ul style="list-style-type: none"> <li>• 2-4 travel lanes**</li> <li>• Median*</li> <li>• Sidewalks &amp; bike facilities</li> <li>• Street furniture &amp; enhanced lighting</li> <li>• On-street parking</li> </ul>

\*For Mixed Use Blvd –Two Travel lanes (A&B), median may be eliminated. See details 100.20 & 100.21.

~~\*\* Determined by documented vehicular traffic volume]~~

### Example Mixed-Use Boulevard Cross Section: Two Travel Lanes

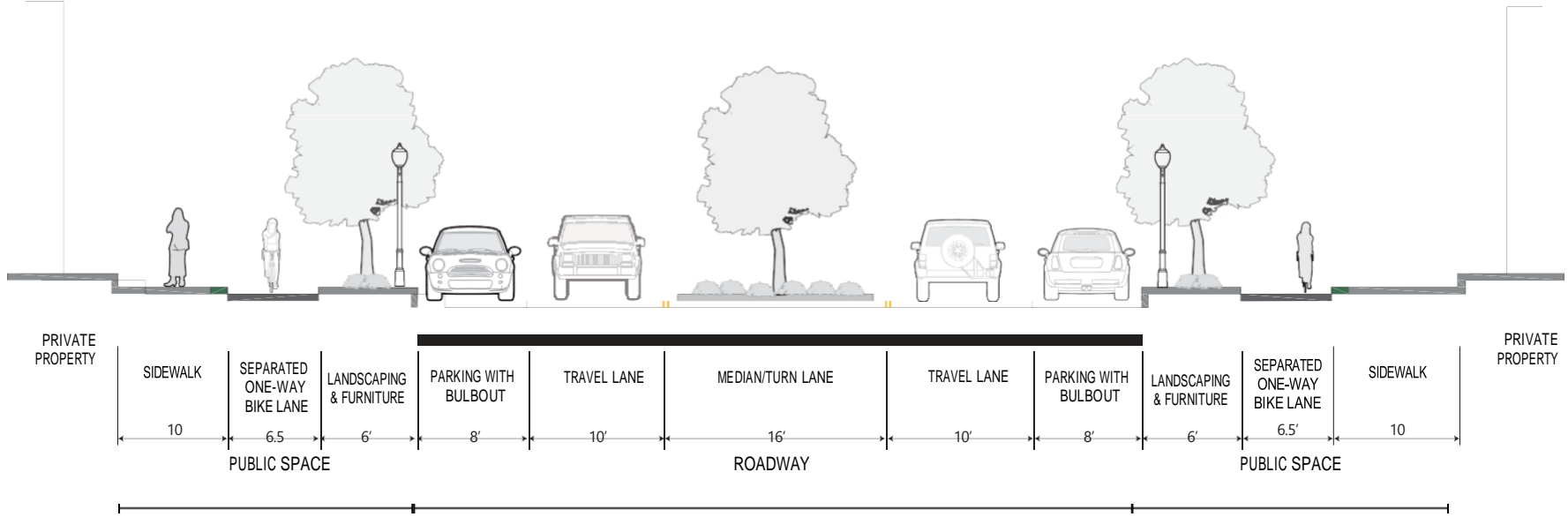

### Example Mixed-Use Boulevard Cross Section: Three Travel Lanes

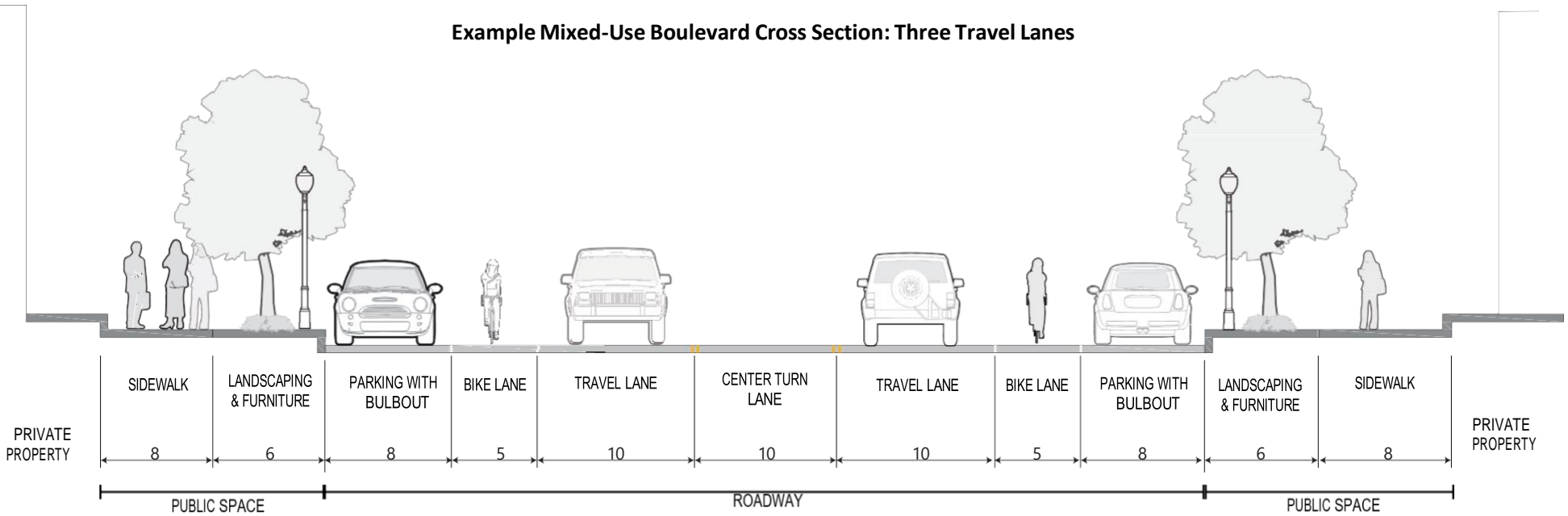

### Example Mixed-Use Boulevard Cross Section: Four Travel Lanes

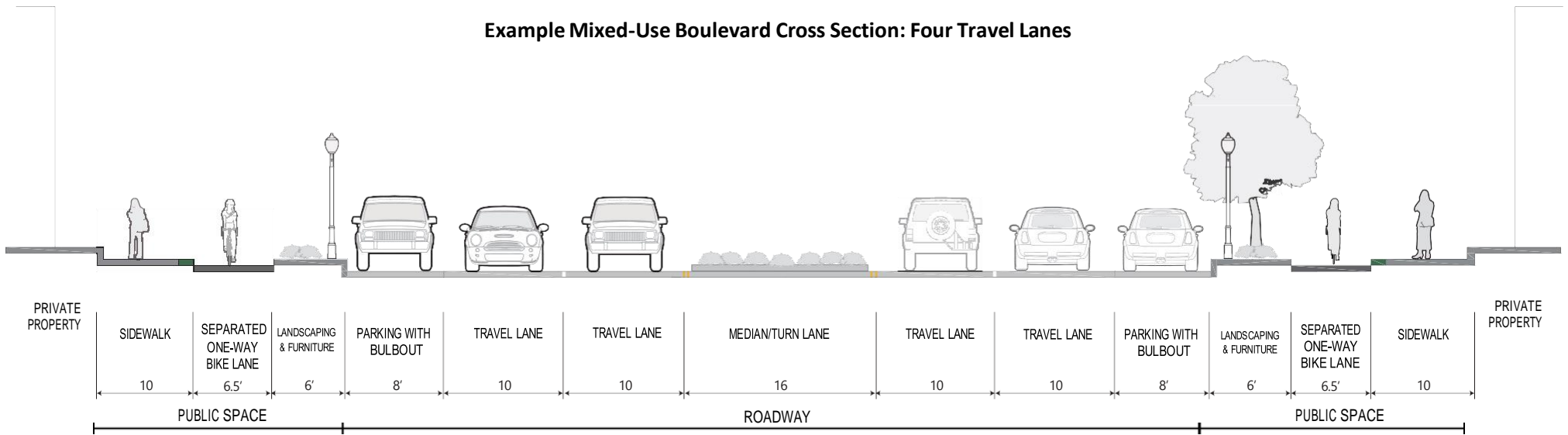

### Neighborhood Connector

Neighborhood Connectors link multiple neighborhoods and provide important walking and bicycling routes between them. Neighborhood Connectors typically have continuous development which may be small- and medium-sized businesses and/or residential; however, the scale of development is less intense than that of the Mixed Use Boulevards. If the neighborhood connector serves as a “main street” destination, it will often have outdoor events and dining along the street edge. These streets encourage bicycle and pedestrian activity and require slow speeds. Major bus routes may occur on these streets. Sidewalk widths will vary depending on the scale of the adjacent residential development. An example cross-section is shown below and additional options are provided in the standard details.

	Description	Typical Features
Neighborhood Connector	<ul style="list-style-type: none"> <li>• Connect multiple neighborhoods</li> <li>• Medium density land uses</li> <li>• Buildings close to street</li> <li>• May feature mixed land uses or be mostly residential with occasional businesses</li> <li>• Heavy pedestrian/bike activity; Provide continuous walking and bicycling routes</li> <li>• Some are major bus routes</li> <li>• Slow speeds (20-25 mph)</li> </ul>	<ul style="list-style-type: none"> <li>• 2 travel lanes</li> <li>• Bike facilities</li> <li>• Sidewalks</li> <li>• Lighting</li> <li>• Enhanced streetscape</li> <li>• In mixed-use/retail areas, space for street furniture, outdoor events &amp; dining</li> <li>• On-street parking</li> </ul>

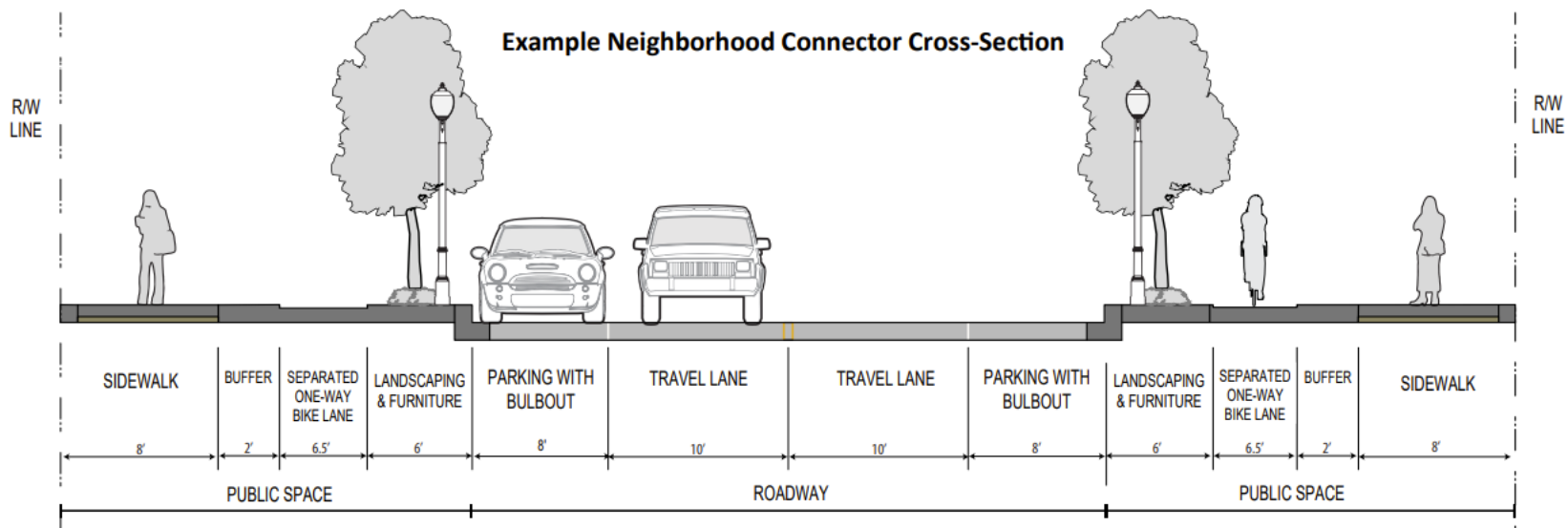

### Neighborhood Residential

Neighborhood Residential Streets have low traffic volumes and provide access to single family and multi-family housing. Despite lower volumes of pedestrians than along Mixed Use Boulevards and Neighborhood Connectors, sidewalks are also important along these streets. Due to the low traffic volumes, bicyclists often share the roadway with motorists. On-street parking is provided although in some locations it may be consolidated to one side of the roadway. An example cross-section is shown below and additional information is provided in the standard details.

Street Type	Description	Typical Features
Neighborhood Residential	<ul style="list-style-type: none"> <li>• Provide immediate access to single-family and multi-family residences</li> <li>• Focus on pedestrian safety and well defined walking paths</li> <li>• Bicyclists typically share the roadway or in unseparated bike lanes</li> <li>• Slow speeds (20 mph)</li> </ul>	<ul style="list-style-type: none"> <li>• 2 travel lanes</li> <li>• Sidewalks</li> <li>• Street trees</li> <li>• Lighting</li> </ul>

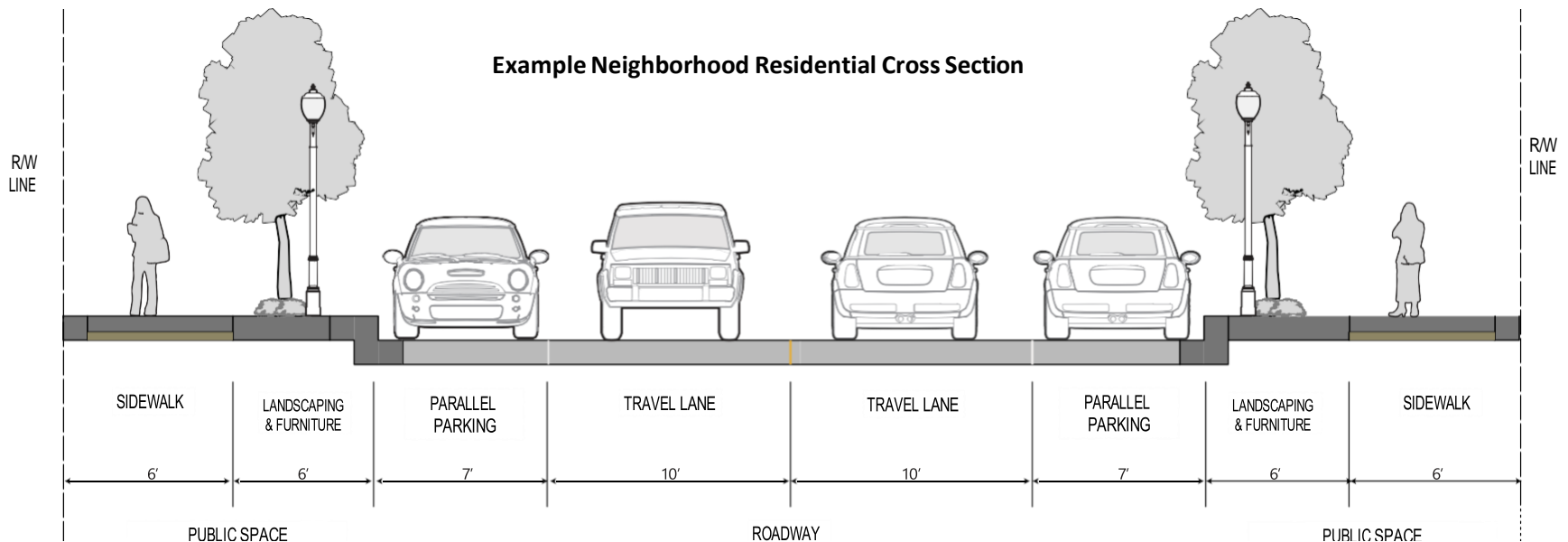

*Industrial Street*

Industrial Streets are fairly limited in the Regional Transit Districts and Local Centers areas, however they do exist. These streets have primarily industrial land uses. It is important to design for moderate to high volumes of trucks while still accommodating some bicyclist and pedestrian use.

Street Type	Description	Typical Features
Industrial Street	<ul style="list-style-type: none"> <li>• Serve industrial areas</li> <li>• Carry moderate to high volumes of trucks of all sizes</li> <li>• Fewer bicyclists and pedestrians, but often they must pass through</li> </ul>	<ul style="list-style-type: none"> <li>• 2 Travel lanes</li> <li>• Adequate street width and turning radii to accommodate trucks</li> <li>• Lighting and Sidewalks</li> </ul>

**Example Industrial Street Cross-Section**

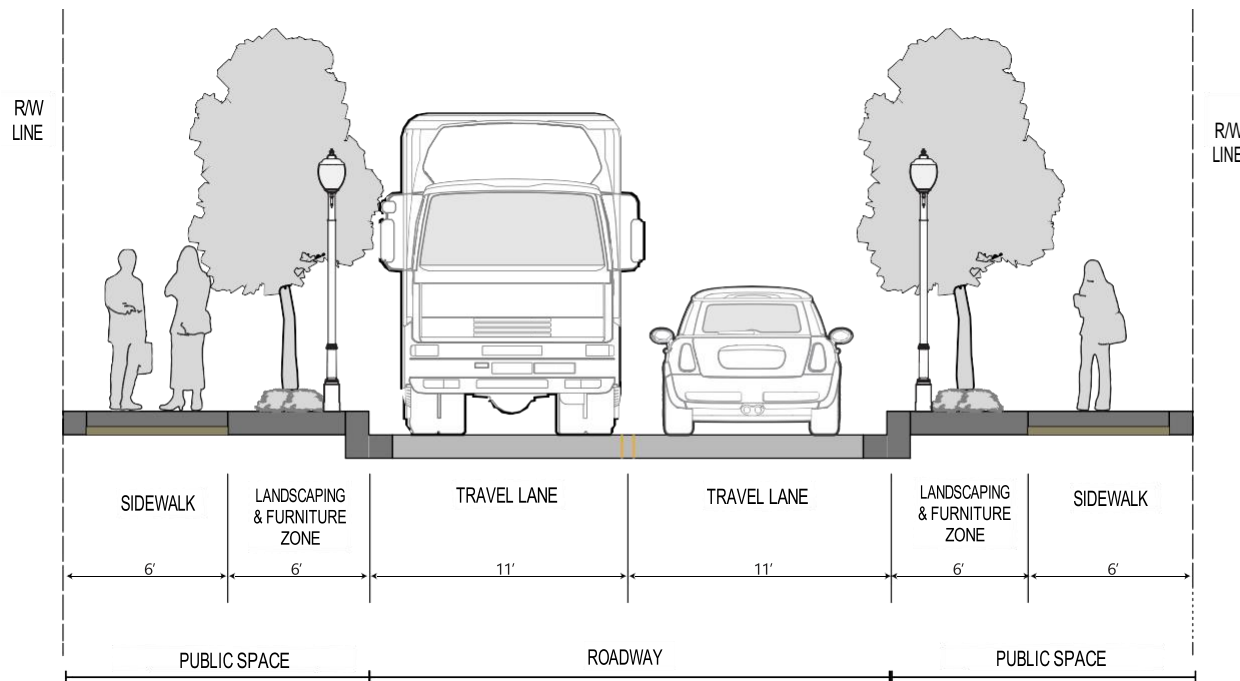

**Shared Street**

A Shared Street is a unique, curbsless, single surface street that can be shared by users of all modes because it is designed for extremely slow speeds (generally no more than 10 mph). The adjacent land uses are mixed and pedestrians are the dominant mode along such streets.

Street Type	Description	Typical Features
Shared Street	<ul style="list-style-type: none"> <li>• Multiple land uses</li> <li>• Single grade or surface shared by all modes</li> <li>• Extremely low speeds (10 mph or less)</li> </ul>	<ul style="list-style-type: none"> <li>• Unique paving</li> <li>• Street furniture</li> <li>• Lighting</li> </ul>

**Example Shared Street Cross-Section**

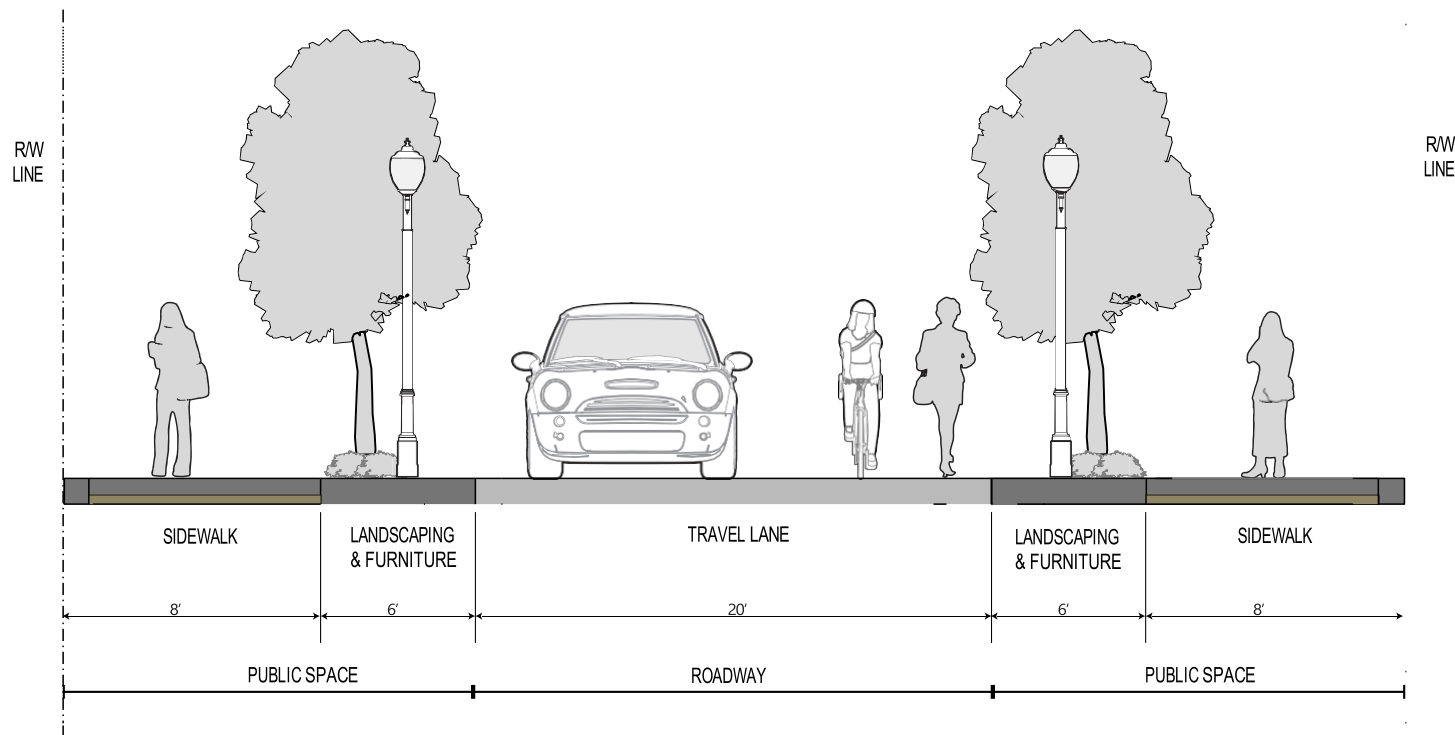



*Alley*

Alleys have an important function in urban areas including deliveries and trash removal. They can also contribute to pedestrian and bicyclist connectivity. They are designed for extremely slow speeds, single vehicle travel and must accommodate room for other objects in the right of way such as trash receptacles.

**Example Alley Cross-Section**

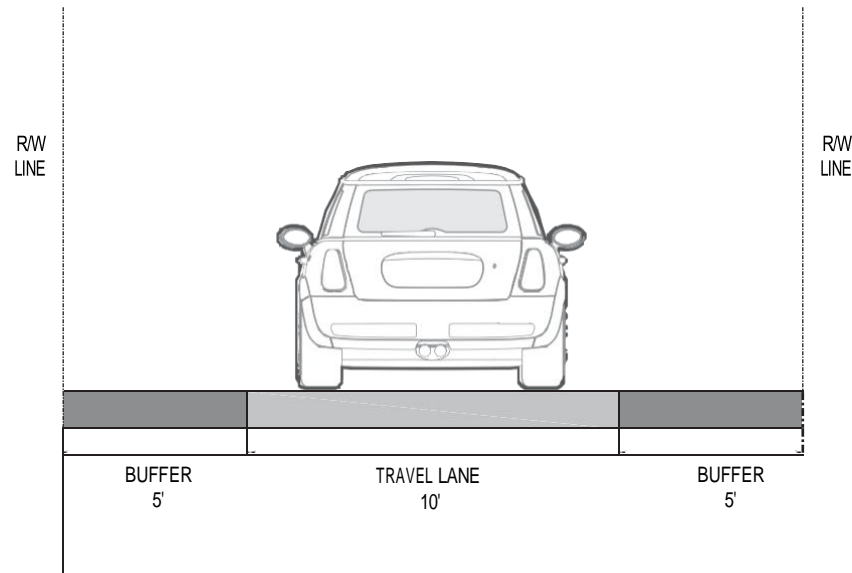

[Summary of Urban Street Design Standards](#)

The following table summarizes the key design elements and street dimensions for the county's urban street design standards. County streets within designated Regional Transit Districts, Local Centers, and Planned Development zones may only be constructed to these standards; no other standards shall be used in the design or construction of such streets. These design elements and standards may be applied elsewhere in the County.

Urban Street Type	Minimum Right of Way	Median Width	Design Speed (mph)	Maximum Travel Lanes	On-Street Parking	Bicycle Facility	Functional Classifications (MPOT)
Mixed Use Boulevard (A) - 2 Travel Lanes	99' (89')(83')	16' (6') (0')	25	2	8'	6.5' separated bike lane	Urban Center Arterial Major Collector
Mixed Use Boulevard (B) - 2 Travel Lanes	92' (82')(76')	16' (6') (0')	25	2	8'	5' bike lane	
Mixed Use Boulevard (A) - 4 Travel Lanes	119' (109')	16' (6')	25	4	8'	6.5' separated bike lane	
Mixed Use Boulevard (B) - 4 Travel Lanes	116' (106')	16' (6')	25	4	8'	5' bike lane with 2' paint barrier	
Mixed Use Boulevard (A) - Center Turn Lane	93'	None	25	2	8'	6.5' separated bike lane	
Mixed Use Boulevard (B) - Center Turn Lane	86'	None	25	2	8'	5' bike lane	Urban Center Arterial Major Collector Collector
Neighborhood Connector(A)	83' (75')	None	20-25	2	8'	6.5' separated bike lane	Urban Center Primary Secondary
Neighborhood Connector (B)	66' (58')	None	20-25	2	8'	5' bike lane	
Neighborhood Residential (New)	60' (53')	None	20	2	7'	5' bike lane	Urban Center N/A
Neighborhood Residential (Existing)	Existing	None	20	2	7'	Add 5' bike lane where ROW permits, otherwise use shared lane marking/signs	Urban Center N/A
Urban Industrial Street	48' (57')	None	20	2	(9')	None	Industrial
Shared Street	50'	None	10	2	None	None	Urban Center Primary Secondary
Alley	20'	None	10	1	None	None	N/A

1) Street tree planting areas will be provided to the specifications of Sections 27-4204(b)(1)(C) or 27-4303 of the Zoning Ordinance. Where multiple zones exist along a block, the most expansive street tree planting areas required shall be provided.

2) Sidewalks will be provided to the specifications of Sections 27-4204(b)(1)(C) or 27-4303 of the Zoning Ordinance. Where multiple zones exist along a block, the widest sidewalk required shall be provided.

3) All intersections shall have a 15' turning radius. 15' turning radii for urban streets (maximum), 25' turning radii for bus and truck routes (maximum). Use effective turning radii & mitigate to accommodate large vehicles.

4) All vehicle travel lanes should be 10' wide except along designated bus routes, where 11' lanes are acceptable. Outside lanes may be expanded to 12' on those blocks containing driveways to loading dock ramps. Lane width restrictions do not apply to Industrial Streets.

5) Slip lanes are prohibited except as outlined in the procedures contained in Section 23-146(d) of the Prince George's County Code.

6) Multiple left turn lanes are strongly discouraged.

7) 11' transit-priority lanes are strongly encouraged on streets with multiple bus routes; along these streets, a four-lane Mixed Use Boulevard design with outside transit priority lanes may be used, where the outside lane is 11' wide, contains red transit priority paint markings, appropriate signage, and may include transit priority signals.

8) Mixed-Use Boulevards designed to ultimately support four travel lanes should be limited to two travel lanes in initial operation to limit vehicular speeds to achieve a 25-mph design speed. The additional horizontal area where the third and fourth lanes would ultimately be reserved for on-street parking, transit priority measures, green space, or other non-automobile use.

# APPENDIX A URBAN STREET DESIGN STANDARDS

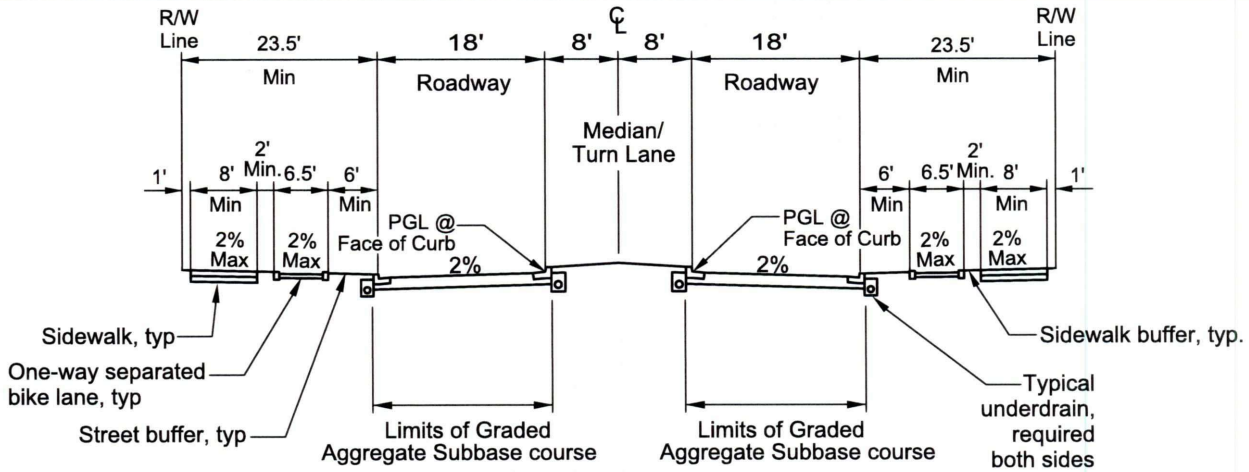

Design Speed	Subgrade (A)	Pavement Section				Min. Right-of-Way Width
		GASB Course (B)	Asphalt Base Course (C)	Intermediate Surface Course (D)	Final Surface Course (E)	
25 MPH	CBR ≥ 7	6"	4 1/2"	2"	2"	99' (89') (83')

**Footnotes**

- A. The top 12" of in-situ subgrade material shall have a minimum California Bearing Ratio (CBR) value of 7. See Table I-3, I-4, I-5, I-6, I-7, I-8 and I-9 of Section I "Roadway Development Guidelines" for subgrade criteria.
- B. Graded Aggregate Subbase (GASB). See Section II "Technical Specifications."
- C. Superpave Asphalt Mix (SAM) base, 25mm, PG 64S-22, Level 2. See Section II "Technical Specifications."
- D. Superpave Asphalt Mix (SAM) surface, 12.5mm, PG 64S-22, Level 2. See Section II "Technical Specifications."
- E. Superpave Asphalt Mix (SAM) surface, 9.5mm, PG 64S-22, Level 2. See Section II "Technical Specifications."

**General Notes**

- 1. Roadway accommodates two (2) 10-foot travel lanes and two (2) 8-foot parking lanes with appropriate striping. Roadway dimensions are measured from face of curb to face of curb. Select travel lanes may be widened to 11' if along a bus route or specified by the Department.
- 2. Curb extensions may be incorporated into the parking lane at intersections. Curb extensions may be incorporated into the parking lane mid-block where appropriate. See Standard 100.37 for Curb extension detail.
- 3. The 6-foot minimum street buffer and 2-foot minimum sidewalk buffer allow space for street trees, lighting, landscaping, street appurtenances and/or stormwater facilities. The sidewalk buffer can be expanded to allow space for street trees.
- 3a. The minimum sidewalk width shown in the detail is a clear zone that must be free of obstructions.
- 3b. Refer to Category 500 for street light standards.
- 3c. Refer to Category 600 for landscaping within the County right-of-way.
- 4. Median can be replaced with left turn lanes at intersections where appropriate. A continuous left turn lane may not be used. Median may incorporate stormwater management to the maximum extent practicable. Designer may choose to reverse the traditional cross slope of the roadway and drain toward the median. See Prince George's County DPIE Stormwater Management Design Manual. In areas where center turn lanes are not needed, the median can either be eliminated or reduced to a 6-foot width to allow for pedestrian refuges at intersections.
- 5. Using the above design speeds, refer to AASHTO: A Policy on Geometric Design of Highways and Streets for additional horizontal and vertical design constraints.
- 6. See Section II "Technical Specifications" for materials and method of construction.
- 7. Refer to Standard 300.13 for underdrain details.
- 8. Refer to Standards 300.01 and 300.02 for curb and gutter details.
- 9. Refer to Standards 300.05 through 300.10 for sidewalk details and median crosswalk details.
- 10. On each side, a 6.5' wide one-way separated bike lane should be incorporated into road section as shown. See detail 100.32 for more information. Non-separated bike lanes or shared lanes may not be used on this road type.
- 11. All unpaved areas within the County right-of-way shall receive a minimum of 3" of topsoil and sod.
- 12. All new construction within the County right-of-way shall comply with Federal accessibility guidelines of the Americans with Disabilities Act.
- 13. For additional design guidance and other reference materials relevant to these standards, Refer to Appendix A: Technical Memorandum on Additional Design Considerations.

APPROVED:  10/4/17  
 DIRECTOR DATE

REVISION DATE:	APPROVED BY:



**DEPARTMENT OF PUBLIC WORKS AND TRANSPORTATION**  
 Prince George's County, MD

Mixed Use Boulevard (A) 2 Travel Lanes	STD. 100.20
---	----------------



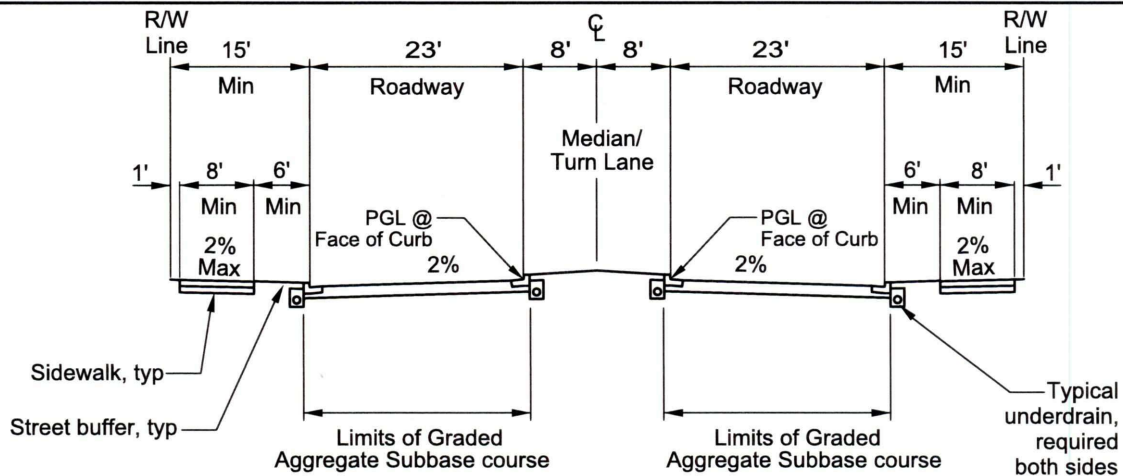

Design Speed	Subgrade (A)	Pavement Section				Min. Right-of-Way Width
		GASB Course (B)	Asphalt Base Course (C)	Intermediate Surface Course (D)	Final Surface Course (E)	
25 MPH	CBR ≥ 7	6"	4 1/2"	2"	2"	92' (82') (76')

**Footnotes**

- A. The top 12" of in-situ subgrade material shall have a minimum California Bearing Ratio (CBR) value of 7. See Table I-3, I-4, I-5, I-6, I-7, I-8 and I-9 of Section I "Roadway Development Guidelines" for subgrade criteria.
- B. Graded Aggregate Subbase (GASB). See Section II "Technical Specifications."
- C. Superpave Asphalt Mix (SAM) base, 25mm, PG 64S-22 Level 2. See Section II "Technical Specifications."
- D. Superpave Asphalt Mix (SAM) surface, 12.5mm, PG 64S-22, Level 2. See Section II "Technical Specifications."
- E. Superpave Asphalt Mix (SAM) surface, 9.5mm, PG 64S-22, Level 2. See Section II "Technical Specifications."

**General Notes**

1. Roadway accommodates two (2) 10-foot travel lanes, two (2) 5-foot bike lanes, and two (2) 8-foot parking lanes with appropriate striping. Roadway dimensions are measured from face of curb to face of curb. Select travel lanes may be widened to 11' if along a bus route or specified by the Department.
2. Curb extensions to be incorporated into the parking lane at intersections. Curb extensions may be incorporated into the parking lane mid-block where appropriate. See Standard 100.37 for Curb extension detail.
3. The 6-foot minimum street buffer along roadway allows space for street trees, lighting, landscaping, street appurtenances and/or stormwater facilities.
- 3a. The minimum sidewalk width shown in the detail is a clear zone that must be free of obstructions.
- 3b. Refer to Category 500 for street light standards.
- 3c. Refer to Category 600 for landscaping within the County right-of-way.
4. Median can be replaced with left turn lanes at intersections where appropriate. A continuous left turn lane may not be used. Median may incorporate stormwater management to the maximum extent practicable. Designer may choose to reverse the traditional cross slope of the roadway and drain toward the median. See Prince George's County DPIE Stormwater Management Design Manual. In areas where center turn lanes are not needed, the median can either be eliminated or reduced to a 6-foot width to allow for pedestrian refuges at intersections.
5. Using the above design speeds, refer to AASHTO: A Policy on Geometric Design of Highways and Streets for additional horizontal and vertical design constraints.
6. See Section II "Technical Specifications" for materials and method of construction.
7. Refer to Standard 300.13 for underdrain details.
8. Refer to Standards 300.01 and 300.02 for curb and gutter details.
9. Refer to Standards 300.05 through 300.10 for sidewalk details and median crosswalk details.
10. All unpaved areas within the County right-of-way shall receive a minimum of 3" of topsoil and sod.
11. All new construction within the County right-of-way shall comply with Federal accessibility guidelines of the Americans with Disabilities Act.
12. For additional design guidance and other reference materials relevant to these standards, Refer to Appendix A: Technical Memorandum on Additional Design Considerations.

APPROVED:

*James S. Alley* 10/4/17  
 DIRECTOR DATE

REVISION DATE: APPROVED BY:





**DEPARTMENT OF PUBLIC WORKS  
 AND TRANSPORTATION  
 Prince George's County, MD**

**Mixed Use  
 Boulevard (B)  
 2 Travel Lanes**

STD.  
 100.21

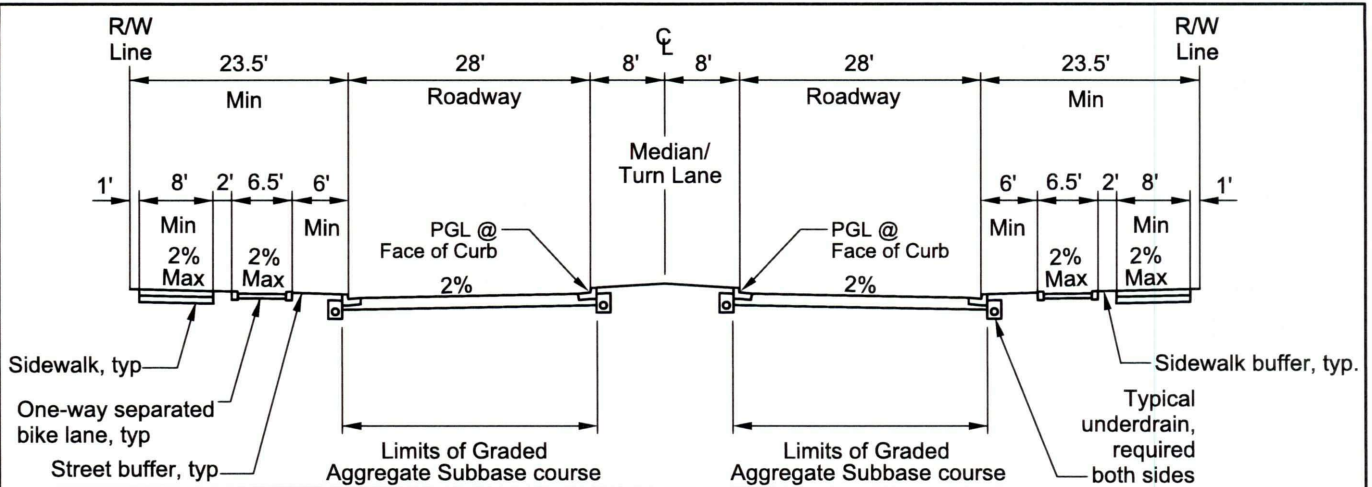



Design Speed	Subgrade (A)	Pavement Section				Min. Right-of-Way Width
		GASB Course (B)	Asphalt Base Course (C)	Intermediate Surface Course (D)	Final Surface Course (E)	
25 MPH	CBR ≥ 7	6"	4 1/2"	2"	2"	119' (109')

**Footnotes**

- A. The top 12" of in-situ subgrade material shall have a minimum California Bearing Ratio (CBR) value of 7. See Table I-3, I-4, I-5, I-6, I-7, I-8 and I-9 of Section I "Roadway Development Guidelines" for subgrade criteria.
- B. Graded Aggregate Subbase (GASB). See Section II "Technical Specifications."
- C. Superpave Asphalt Mix (SAM) base, 25mm, PG 64S-22, Level 2. See Section II "Technical Specifications."
- D. Superpave Asphalt (SAM) surface, 12.5mm, PG 64S-22, Level 2. See Section II "Technical Specifications."
- E. Superpave Asphalt (SAM) surface, 9.5mm, PG 64S-22, Level 2. See Section II "Technical Specifications."

**General Notes**

1. Roadway accommodates four (4) 10-foot travel lanes and two (2) 8-foot parking lanes with appropriate striping. Roadway dimensions are measured from face of curb to face of curb. Specific travel lanes may be widened to 11' if along a bus route or specified by the Department.
2. Curb extensions to be incorporated into the parking lane at intersections. Curb extensions may be incorporated into the parking lane mid-block where appropriate. See Standard 100.37 for Curb extension detail.
3. The 6-foot minimum street buffer and 2-foot minimum sidewalk buffer allow space for street trees, lighting, landscaping, street appurtenances and/or stormwater facilities. The sidewalk buffer can be expanded to allow space for street trees.
- 3a. The minimum sidewalk width shown in the detail is a clear zone that must be free of obstructions.
- 3b. Refer to Category 500 for street light standards.
- 3c. Refer to Category 600 for landscaping within the County right-of-way.
4. Median can be replaced with left turn lanes at intersections where appropriate. A continuous left turn lane may not be used. Median may incorporate stormwater management to the maximum extent practicable. Designer may choose to reverse the traditional cross slope of the roadway and drain toward the median. See Prince George's County DP&E Stormwater Management Design Manual. In areas where center turn lanes are not needed, the median width can be reduced to 6-foot to allow for pedestrian refuges at intersections.
5. Using the above design speeds, refer to AASHTO: A Policy on Geometric Design of Highways and Streets for additional horizontal and vertical design constraints.
6. See Section II "Technical Specifications" for materials and method of construction.
7. Refer to Standard 300.13 for underdrain details.
8. Refer to Standards 300.01 and 300.02 for curb and gutter details.
9. Refer to Standards 300.05 through 300.10 for sidewalk details and median crosswalk details.
10. On each side, a 6.5' wide, one-way separated bike lane should be incorporated into road section as shown. See detail 100.32 for more information. Non-separated bike lanes or shared lanes may not be used on this road type.
11. All unpaved areas within the County right-of-way shall receive a minimum of 3" of topsoil and sod.
12. All new construction within the County right-of-way shall comply with Federal accessibility guidelines of the Americans with Disabilities Act.
13. For additional design guidance and other reference materials relevant to these standards, Refer to Appendix A: Technical Memorandum on Additional Design Considerations.

APPROVED:  10/4/17  
 DIRECTOR DATE

REVISION DATE:	APPROVED BY:

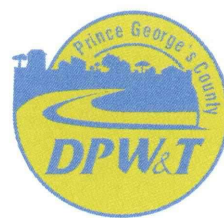

**DEPARTMENT OF PUBLIC WORKS  
AND TRANSPORTATION**  
Prince George's County, MD

Mixed Use Boulevard (A) 4 Travel Lanes	STD. 100.22
--	----------------



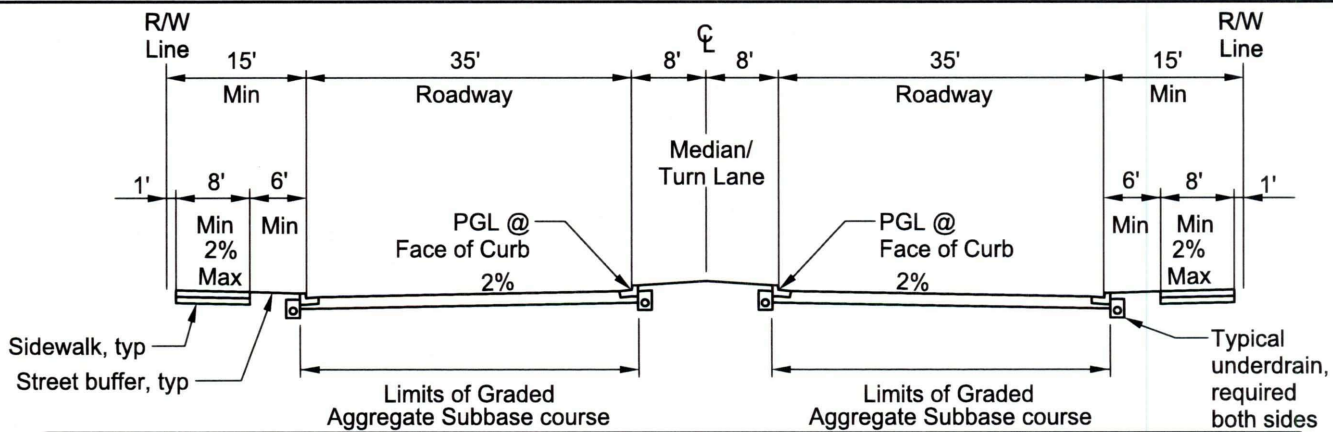

Design Speed	Subgrade (A)	Pavement Section				Min. Right-of-Way Width
		GASB Course (B)	Asphalt Base Course (C)	Intermediate Surface Course (D)	Final Surface Course (E)	
25 MPH	CBR ≥ 7	6"	4 1/2"	2"	2"	116' (106')

**Footnotes**

- A. The top 12" of in-situ subgrade material shall have a minimum California Bearing Ratio (CBR) value of 7. See Table I-3, I-4, I-5, I-6, I-7, I-8 and I-9 of Section I "Roadway Development Guidelines" for subgrade criteria.
- B. Graded Aggregate Subbase (GASB). See Section II "Technical Specifications."
- C. Superpave Asphalt Mix (SAM) base, 25mm, PG 64S-22, Level 2. See Section II "Technical Specifications."
- D. Superpave Asphalt Mix (SAM) surface, 12.5mm, PG 64S-22, Level 2. See Section II "Technical Specifications."
- E. Superpave Asphalt Mix (SAM) surface, 9.5mm, PG 64S-22, Level 2. See Section II "Technical Specifications."

**General Notes**

- 1. Roadway accommodates four (4) 10-foot travel lanes, two (2) 5-foot buffered bike lanes with 2-foot painted buffers and two (2) 8-foot parking lanes with appropriate striping. Roadway dimensions are measured from face of curb to face of curb. Specific travel lanes may be widened to 11' if along a bus route or specified by the Department.
- 2. Curb extensions to be incorporated into the parking lane at intersections. Curb extensions may be incorporated into the parking lane mid-block where appropriate. See Standard 100.37 for Curb extension detail.
- 3. The 6-foot minimum street buffer along roadway allows space for street trees, lighting, landscaping, street appurtenances and/or stormwater facilities.
- 3a. The minimum sidewalk width shown in the detail is a clear zone that must be free of obstructions.
- 3b. Refer to Category 500 for street light standards.
- 3c. Refer to Category 600 for landscaping within the County right-of-way.
- 4. Median can be replaced with left turn lanes at intersections where appropriate. A continuous left turn lane must not be used. Median may incorporate stormwater management to the maximum extent practicable. Designer may choose to reverse the traditional cross slope of the roadway and drain toward the median. See Prince George's County DPIE Stormwater Management Design Manual. In areas where center turn lanes are not needed, the median width can be reduced to 6-foot to allow for pedestrian refuges at intersections.
- 5. Using the above design speeds, refer to AASHTO: A Policy on Geometric Design of Highways and Streets for additional horizontal and vertical design constraints.
- 6. See Section II "Technical Specifications" for materials and method of construction.
- 7. Refer to Standard 300.13 for underdrain details.
- 8. Refer to Standards 300.01 and 300.02 for curb and gutter details.
- 9. Refer to Standards 300.05 through 300.10 for sidewalk details and median crosswalk details.
- 10. All unpaved areas within the County right-of-way shall receive a minimum of 3" of topsoil and sod.
- 11. All new construction within the County right-of-way shall comply with Federal accessibility guidelines of the Americans with Disabilities Act.
- 12. For additional design guidance and other reference materials relevant to these standards, Refer to Appendix A: Technical Memorandum on Additional Design Considerations.

APPROVED:	
	10/4/17
DIRECTOR	DATE
REVISION DATE:	APPROVED BY:



<b>DEPARTMENT OF PUBLIC WORKS AND TRANSPORTATION Prince George's County, MD</b>	
<b>Mixed Use Boulevard (B) 4 Travel Lanes</b>	STD. 100.23



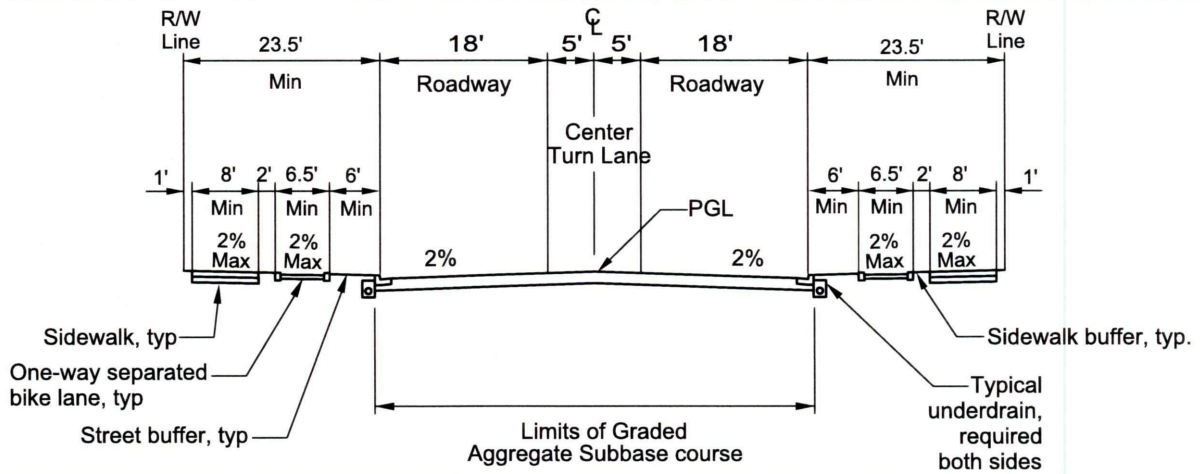

Design Speed	Subgrade (A)	Pavement Section				Min. Right-of-Way Width
		GASB Course (B)	Asphalt Base Course (C)	Intermediate Surface Course (D)	Final Surface Course (E)	
25 MPH	CBR ≥ 7	6"	4 1/2"	2"	2"	93'

**Footnotes**

- A. The top 12" of in-situ subgrade material shall have a minimum California Bearing Ratio (CBR) value of 7. See Table I-3, I-4, I-5, I-6, I-7, I-8 and I-9 of Section I "Roadway Development Guidelines" for subgrade criteria.
- B. Graded Aggregate Subbase (GASB). See Section II "Technical Specifications."
- C. Superpave Asphalt Mix (SAM) base, 25mm, PG 64S-22, Level 2. See Section II "Technical Specifications."
- D. Superpave Asphalt Mix (SAM) surface, 12.5mm, PG 64S-22, Level 2. See Section II "Technical Specifications."
- E. Superpave Asphalt Mix (SAM) surface, 9.5mm, PG 64S-22, Level 2. See Section II "Technical Specifications."

**General Notes**

1. Roadway accommodates two (2) 10-foot travel lanes, two (2) 8-foot parking lanes and one (1) 10-foot center turn lane with appropriate striping. Roadway dimensions are measured from face of curb to face of curb. Select travel lanes may be widened to 11' if along a bus route or specified by the department.
2. Curb extensions to be incorporated into the parking lane at intersections. Curb extensions may be incorporated into the parking lane mid-block where appropriate. See Standard 100.37 for Curb extension detail.
3. The 6-foot minimum street buffer and 2-foot minimum sidewalk buffer allow space for street trees, lighting, landscaping, street appurtenances and/or stormwater facilities. The sidewalk buffer can be expanded to allow space for street trees.
- 3a. The minimum sidewalk width shown in the detail is a clear zone that must be free of obstructions.
- 3b. Refer to Category 500 for street light standards.
- 3c. Refer to Category 600 for landscaping within the County right-of-way.
4. Using the above design speeds, refer to AASHTO: A Policy on Geometric Design of Highways and Streets for additional horizontal and vertical design constraints.
5. See Section II "Technical Specifications" for materials and method of construction.
6. Refer to Standard 300.13 for underdrain details.
7. Refer to Standards 300.01 and 300.02 for curb and gutter details.
8. Refer to Standards 300.05 through 300.10 for sidewalk details and median crosswalk details.
9. On each side, a 6.5' wide, one-way separated bike lane should be incorporated into road section as shown. See detail 100.32 for more information. Non-separated bike lanes or shared lanes may not be used on this road type.
10. All unpaved areas within the County right-of-way shall receive a minimum of 3" of topsoil and sod.
11. All new construction within the County right-of-way shall comply with Federal accessibility guidelines of the Americans with Disabilities Act.
12. For additional design guidance and other reference materials relevant to these standards, Refer to Appendix A: Technical Memorandum on Additional Design Considerations.

APPROVED	
<i>James S. Ashley</i>	10/4/17
DIRECTOR	DATE
REVISION DATE:	APPROVED BY:



<b>DEPARTMENT OF PUBLIC WORKS AND TRANSPORTATION</b> Prince George's County, MD	
<b>Mixed Use Boulevard (A) Center Turn Lane</b>	STD. 100.24



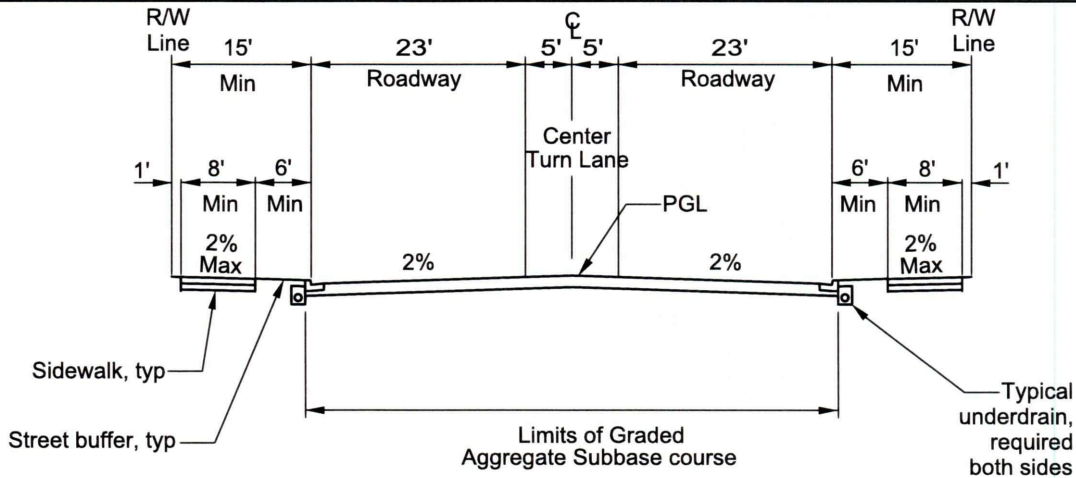

Design Speed	Subgrade (A)	Pavement Section				Min. Right-of-Way Width
		GASB Course (B)	Asphalt Base Course (C)	Intermediate Surface Course (D)	Final Surface Course (E)	
25 MPH	CBR ≥ 7	6"	4 1/2"	2"	2"	86'

**Footnotes**

- A. The top 12" of in-situ subgrade material shall have a minimum California Bearing Ratio (CBR) value of 7. See Table I-3, I-4, I-5, I-6, I-7, I-8 and I-9 of Section I "Roadway Development Guidelines" for subgrade criteria.
- B. Graded Aggregate Subbase (GASB). See Section II "Technical Specifications."
- C. Superpave Asphalt Mix (SAM) base, 25mm, PG 64S-22 Level 2. See Section II "Technical Specifications."
- D. Superpave Asphalt Mix (SAM) surface, 12.5mm, PG 64S-22, Level 2. See Section II "Technical Specifications."
- E. Superpave Asphalt Mix (SAM) surface, 9.5mm, PG 64S-22, Level 2. See Section II "Technical Specifications."

**General Notes**

- 1. Roadway accommodates two (2) 10-foot travel lanes, two (2) 5-foot bike lanes, two (2) 8-foot parking lanes and one (1) 10-foot center turn lane with appropriate striping. Roadway dimensions are measured from face of curb to face of curb. Select travel lanes may be widened to 11' if along a bus route or specified by the department.
- 2. Curb extensions to be incorporated into the parking lane at intersections. Curb extensions may be incorporated into the parking lane mid-block where appropriate. See Standard 100.37 for Curb extension detail.
- 3. The 6-foot minimum street buffer along roadway allows space for street trees, lighting, landscaping, street appurtenances and/or stormwater facilities.
- 3a. The minimum sidewalk width shown in the detail is a clear zone that must be free of obstructions.
- 3b. Refer to Category 500 for street light standards.
- 3c. Refer to Category 600 for landscaping within the County right-of-way.
- 4. Using the above design speeds, refer to AASHTO: A Policy on Geometric Design of Highways and Streets for additional horizontal and vertical design constraints.
- 5. See Section II "Technical Specifications" for materials and method of construction.
- 6. Refer to Standard 300.13 for underdrain details.
- 7. Refer to Standards 300.01 and 300.02 for curb and gutter details.
- 8. Refer to Standards 300.05 through 300.10 for sidewalk details and median crosswalk details.
- 9. All unpaved areas within the County right-of-way shall receive a minimum of 3" of topsoil and sod.
- 10. All new construction within the County right-of-way shall comply with Federal accessibility guidelines of the Americans with Disabilities Act.
- 11. For additional design guidance and other reference materials relevant to these standards, Refer to Appendix A: Technical Memorandum on Additional Design Considerations.

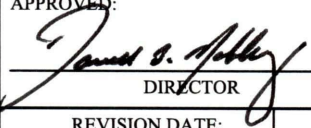
APPROVED:  10/4/17  
 DIRECTOR DATE

REVISION DATE: APPROVED BY:



**DEPARTMENT OF PUBLIC WORKS AND TRANSPORTATION**  
**Prince George's County, MD**

Mixed Use Boulevard (B)  
 Center Turn Lane

STD.  
 100.25

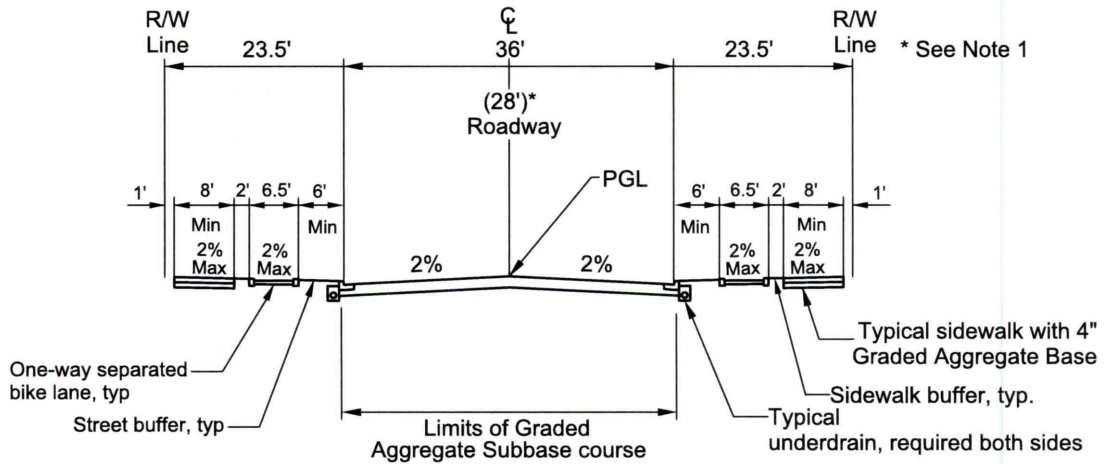

Design Speed	Subgrade (A)	Pavement Section				Min. Right-of-Way Width
		GASB Course (B)	Asphalt Base Course (C)	Intermediate Surface Course (D)	Final Surface Course (E)	
20-25 MPH	CBR ≥ 7	6"	4 1/2"	2"	2"	83' (75')

**Footnotes**

- A. The top 12" of in-situ subgrade material shall have a minimum California Bearing Ratio (CBR) value of 7. See Table I-3, I-4, I-5, I-6, I-7, I-8 and I-9 of Section I "Roadway Development Guidelines" for subgrade criteria.
- B. Graded Aggregate Subbase (GASB). See Section II "Technical Specifications."
- C. Superpave Asphalt (SAM) base, 25mm, PG 64S-22, Level 2. See Section II "Technical Specifications."
- D. Superpave Asphalt (SAM) surface, 12.5mm, PG 64S-22, Level 2. See Section II "Technical Specifications."
- E. Superpave Asphalt (SAM) surface, 9.5mm, PG 64S-22, Level 2. See Section II "Technical Specifications."

**General Notes**

- 1. Roadway accommodates two (2) 10-foot travel lane and two (2) 8-foot parking lanes with appropriate striping. Alternative configuration shown in parenthesis accommodates two (2) 10-foot travel lanes and one (1) 8-foot parking lane. Roadway dimensions are measured from face of curb to face of curb. Select travel lane may be widened to 11' if along a bus route or specified by the Department.
- 2. Curb extensions to be incorporated into the parking lane at intersections. Curb extensions may be incorporated into the parking lane mid-block where appropriate. See Standard 100.37 for Curb extension detail.
- 3. The 6-foot minimum street buffer and 2 foot minimum sidewalk buffer allow space for street trees, lighting, landscaping, street appurtenances and/or stormwater facilities. The sidewalk buffer can be expanded to allow space for street trees.
- 3a. The minimum sidewalk width shown in the detail is a clear zone that must be free of obstructions.
- 3b. Refer to Category 500 for street light standards.
- 3c. Refer to Category 600 for landscaping within the County right-of-way.
- 4. Using the above design speeds, refer to AASHTO: A Policy on Geometric Design of Highways and Streets for additional horizontal and vertical design constraints.
- 5. See Section II "Technical Specifications" for materials and method of construction.
- 6. Refer to Standard 300.13 for underdrain details.
- 7. Refer to Standards 300.01 and 300.02 for curb and gutter details.
- 8. Refer to Standards 300.05 through 300.08 for sidewalk and curb ramp details.
- 9. On each side, a 6.5' wide, one-way separated bike lane should be incorporated into road section as shown. See detail 100.32 for more information. Non separated bike lanes or shared lanes may not be used on this road type.
- 10. All unpaved areas within the County right-of-way shall receive a minimum of 3" of topsoil and sod.
- 11. All new construction within the County right-of-way shall comply with Federal accessibility guidelines of the Americans with Disabilities Act.
- 12. For additional design guidance and other reference materials relevant to these standards, Refer to Appendix A: Technical Memorandum on Additional Design Considerations.

APPROVED:

*David S. Alley* 10/4/17  
 DIRECTOR DATE

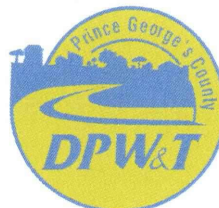

**DEPARTMENT OF PUBLIC WORKS  
 AND TRANSPORTATION  
 Prince George's County, MD**

REVISION DATE:	APPROVED BY:

**Neighborhood  
 Connector (A)**

STD.  
 100.26



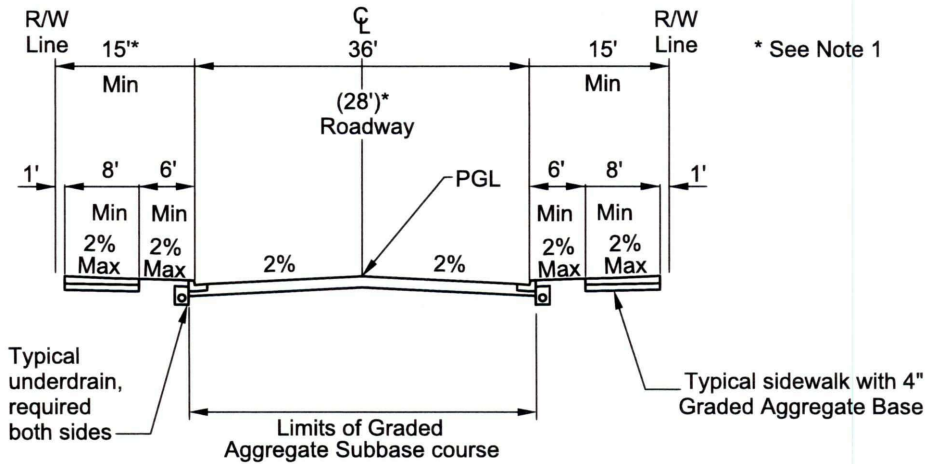

Design Speed	Subgrade (A)	Pavement Section				Min. Right-of-Way Width
		GASB Course (B)	Asphalt Base Course (C)	Intermediate Surface Course (D)	Final Surface Course (E)	
20-25 MPH	CBR ≥ 7	6"	4 1/2"	2"	2"	66' (58')

**Footnotes**

- A. The top 12" of in-situ subgrade material shall have a minimum California Bearing Ratio (CBR) value of 7. See Table I-3, I-4, I-5, I-6, I-7, I-8 and I-9 of Section I "Roadway Development Guidelines" for subgrade criteria.
- B. Graded Aggregate Subbase (GASB). See Section II "Technical Specifications."
- C. Superpave Asphalt Mix (SAM) base, 25mm, PG 64S-22, Level 2. See Section II "Technical Specifications."
- D. Superpave Asphalt Mix (SAM) surface, 12.5mm, PG 64S-22, Level 2. See Section II "Technical Specifications."
- E. Superpave Asphalt Mix (SAM) surface, 9.5mm, PG 64S-22, Level 2. See Section II "Technical Specifications."

**General Notes**

- 1. Roadway accommodates two (2) 10-foot travel lane and two (2) 8-foot parking lanes with appropriate striping. Alternative configuration shown in parenthesis accommodates two (2) 10-foot travel lanes and one (1) 8-foot parking lane. Roadway dimensions are measured from face of curb to face of curb. Select travel lanes may be widened to 11' if along a bus route or specified by the Department.
- 2. Curb extensions to be incorporated into the parking lane at intersections. Curb extensions may be incorporated into the parking lane mid-block where appropriate. See Standard 100.37 for Curb extension detail.
- 3. The 6-foot minimum street buffer between roadway and sidewalk allows space for street trees, lighting, landscaping, street appurtenances and/or stormwater facilities.
- 3a. The minimum sidewalk width shown in the detail is a clear zone that must be free of obstructions.
- 3b. Refer to Category 500 for street light standards.
- 3c. Refer to Category 600 for landscaping within the County right-of-way.
- 4. Using the above design speeds, refer to AASHTO: A Policy on Geometric Design of Highways and Streets for additional horizontal and vertical design constraints.
- 5. See Section II "Technical Specifications" for materials and method of construction.
- 6. Refer to Standard 300.13 for underdrain details.
- 7. Refer to Standards 300.01 and 300.02 for curb and gutter details.
- 8. Refer to Standards 300.05 through 300.08 for sidewalk and curb ramp details.
- 9. Roadway and right-of-way may be expanded to accommodate bike lane pairs within the roadway.
- 10. All unpaved areas within the County right-of-way shall receive a minimum of 3" of topsoil and sod.
- 11. All new construction within the County right-of-way shall comply with Federal accessibility guidelines of the Americans with Disabilities Act.
- 12. For additional design guidance and other reference materials relevant to these standards, Refer to Appendix A: Technical Memorandum on Additional Design Considerations.

APPROVED: *James S. Kelly* 10/4/17  
 DIRECTOR DATE

REVISION DATE:	APPROVED BY:



**DEPARTMENT OF PUBLIC WORKS  
 AND TRANSPORTATION  
 Prince George's County, MD**

**Neighborhood  
 Connector (B)**      STD.  
 100.27

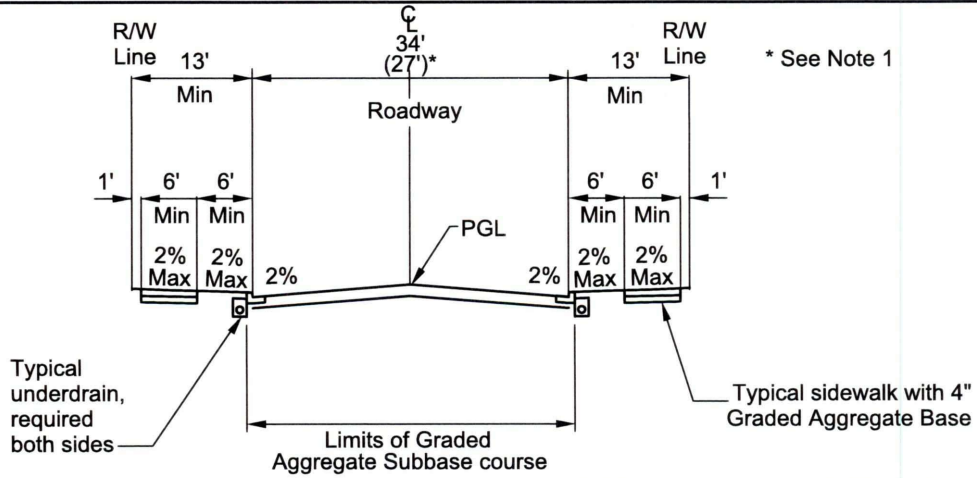



Design Speed	Subgrade (A)	Pavement Section				Min. Right-of-Way Width
		GASB Course (B)	Asphalt Base Course (C)	Intermediate Surface Course (D)	Final Surface Course (E)	
20 MPH	CBR ≥ 7	4"	3"	1 1/2"	1 1/2"	60' (53')

**Footnotes**

- A. The top 12" of in-situ subgrade material shall have a minimum California Bearing Ratio (CBR) value of 7. See Table I-3, I-4, I-5, I-6, I-7, I-8 and I-9 of Section I "Roadway Development Guidelines" for subgrade criteria.
- B. Graded Aggregate Subbase (GASB). See Section II "Technical Specifications."
- C. Superpave Asphalt Mix (SAM) base, 19mm, PG 64S-22, Level 2. See Section II "Technical Specifications."
- D. Superpave Asphalt Mix (SAM) surface, 9.5mm, PG 64S-22, Level 2. See Section II "Technical Specifications."
- E. Superpave Asphalt Mix (SAM) surface, 9.5mm, PG 64S-22, Level. See Section II "Technical Specifications."

**General Notes**

- 1. Roadway accommodates two (2) 10-foot travel lane and two (2) 7-foot parking lanes. Alternative configuration shown in parenthesis accomodates two (2) 10-foot travel lanes and one (1) 7-foot parking lane. Roadway dimensions are measured from face of curb to face of curb.
- 2. Curb extentions to be incorporated into the parking lane at intersections. Curb extentions may be incorporated into the parking lane mid-block where appropriate. See standard 100.37 for Curb extension detail.
- 3. The 6-foot minimum street buffer between roadway and sidewalk allows space for street trees, lighting, landscaping, street appurtenances and/or stormwater facilities.
- 3a. The minimum sidewalk width shown in the detail is a clear zone that must be free of obstructions.
- 3b. Refer to Category 500 for street light standards.
- 3c. Refer to Category 600 for landscaping within the County right-of-way.
- 4. Using the above design speeds, refer to AASHTO: A Policy on Geometric Design of Highways and Streets for additional horizontal and vertical design constraints.
- 5. See Section II "Technical Specifications" for materials and method of construction.
- 6. Refer to Standard 300.13 for underdrain details.
- 7. Refer to Standards 300.01 and 300.02 for curb and gutter details.
- 8. Refer to Standards 300.05 through 300.08 for sidewalk and curb ramp details.
- 9. Roadway and right-of-way may be expanded to accomodate bike lane pairs within the roadway. See detail 100.32
- 10. All unpaved areas within the County right-of-way shall receive a minimum of 3" of topsoil and sod.
- 11. All new construction within the County right-of-way shall comply with Federal accessibility guidelines of the Americans with Disabilities Act.
- 12. For additional design guidance and other reference materials relevant to these standards, Refer to Appendix A: Technical Memorandum on Additional Design Considerations.

APPROVED:  10/4/17 DIRECTOR DATE			<b>DEPARTMENT OF PUBLIC WORKS AND TRANSPORTATION Prince George's County, MD</b>	
REVISION DATE:	APPROVED BY:		Neighborhood Residential	STD. 100.28



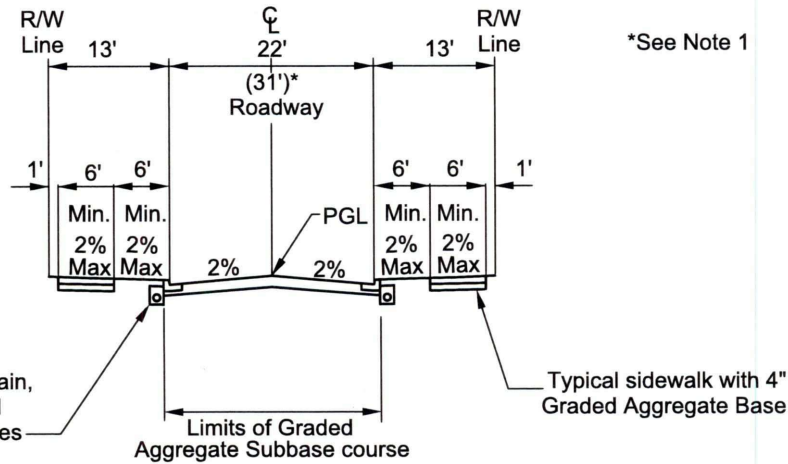

Design Speed	Subgrade (A)	Pavement Section				Min. Right-of-Way Width
		GASB Course (B)	Asphalt Base Course (C)	Intermediate Surface Course (D)	Final Surface Course (E)	
20 MPH	CBR ≥ 7	6"	4 1/2"	2"	2"	48' (57')

Footnotes

- A. The top 12" of in-situ subgrade material shall have a minimum California Bearing Ratio (CBR) value of 7. See Table I-3, I-4, I-5, I-6, I-7, I-8 and I-9 of Section I "Roadway Development Guidelines" for subgrade criteria.
- B. Graded Aggregate Subbase (GASB). See Section II "Technical Specifications."
- C. Superpave Asphalt Mix (SAM) base, 25mm, PG 64S-22, Level 2. See Section II "Technical Specifications."
- D. Superpave Asphalt Mix (SAM) surface, 12.5mm, PG 64S-22, Level 2. See Section II "Technical Specifications."
- E. Superpave Asphalt (SAM) surface, 9.5mm, PG 64S-22, Level 2. See Section II "Technical Specifications."

General Notes

1. Roadway accommodates two (2) 11-foot travel lanes. Alternative configuration shown in parenthesis accommodate two (2) 11-foot travel lanes and one (1) 9-foot parking lane. Roadway dimensions are measured from face of curb to face of curb.
2. The 6-foot street buffer between roadway and sidewalk allows space for street trees, lighting, landscaping, street appurtenances and/or stormwater facilities.
- 2a. All street furniture and appurtenances must be outside the 6-foot minimum pedestrian sidewalk.
- 2b. Refer to Category 500 for street light standards.
- 2c. Refer to Category 600 for landscaping within the County right-of-way.
3. Using the above design speeds, refer to AASHTO: A Policy on Geometric Design of Highways and Streets for additional horizontal and vertical design constraints.
4. See Section II "Technical Specifications" for materials and method of construction.
5. Refer to Standard 300.13 for underdrain details.
6. Refer to Standards 300.01 and 300.02 for curb and gutter details.
7. Refer to Standards 300.05 through 300.08 for sidewalk and curb ramp details.
8. Roadway and right-of-way may be expanded to accommodate unseparated bike lane pairs within the roadway. See detail 100.32
9. All unpaved areas within the County right-of-way shall receive a minimum of 3" of topsoil and sod.
10. All new construction within the County right-of-way shall comply with Federal accessibility guidelines of the Americans with Disabilities Act.
11. For additional design guidance and other reference materials relevant to these standards, Refer to Appendix A: Technical Memorandum on Additional Design Considerations.

APPROVED:  10/4/17  
 DIRECTOR      DATE

REVISION DATE:	APPROVED BY:

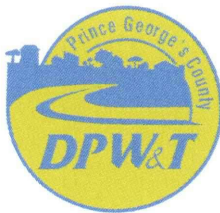

**DEPARTMENT OF PUBLIC WORKS  
AND TRANSPORTATION  
Prince George's County, MD**

**Industrial  
Road**

STD.  
100.29

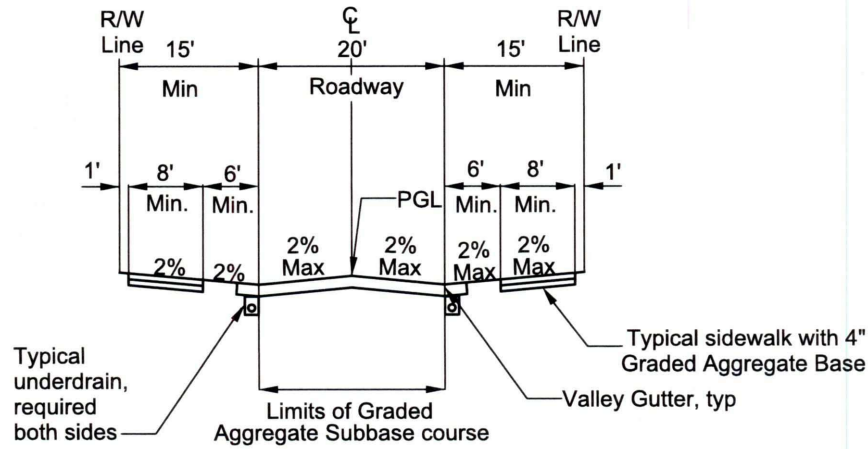

Design Speed	Subgrade (A)	Pavement Section				Min. Right-of-Way Width
		GASB Course (B)	Asphalt Base Course (C)	Intermediate Surface Course (D)	Final Surface Course (E)	
10 MPH	CBR $\geq$ 7	4"	3"	1 1/2"	1 1/2"	50'

**Footnotes**

- A. The top 12" of in-situ subgrade material shall have a minimum California Bearing Ratio (CBR) value of 7. See Table I-3, I-4, I-5, I-6, I-7, I-8 and I-9 of Section I "Roadway Development Guidelines" for subgrade criteria.
- B. Graded Aggregate Subbase (GASB). See Section II "Technical Specifications."
- C. Superpave Asphalt Mix (SAM) base, 19mm, PG 64S-22, Level 2. See Section II "Technical Specifications."
- D. Superpave Asphalt Mix (SAM) surface, 9.5mm, PG 64S-22, Level 2. See Section II "Technical Specifications."
- E. Superpave Asphalt Mix (SAM) surface, 9.5mm, PG 64S-22, Level 2. See Section II "Technical Specifications."

**General Notes**

- 1. Roadway accommodates two (2) 10-foot travel lanes when vehicles are allowed. Roadway dimensions are measured from flowline of valley gutter.
- 2. Roadway shall have surface treatment/texture or alternative materials (pavers, bricks, etc.) to signify shared space for all users.
- 3. The 6-foot street buffer between roadway and sidewalk allows space for street trees, lighting, landscaping, street appurtenances and/or stormwater facilities.
- 3a. The minimum sidewalk width shown in the detail is a clear zone that must be free of obstructions.
- 3b. Refer to Category 500 for street light standards.
- 3c. Refer to Category 600 for landscaping within the County right-of-way.
- 4. Using the above design speeds, refer to AASHTO: A Policy on Geometric Design of Highways and Streets for additional horizontal and vertical design constraints.
- 5. See Section II "Technical Specifications" for materials and method of construction.
- 6. Refer to Standard 300.13 for underdrain details.
- 7. Refer to Standards 100.39 for Valley Gutter detail
- 8. Refer to Standards 300.05 through 300.08 for sidewalk and curb ramp details
- 9. All unpaved areas within the County right-of-way shall receive a minimum of 3" of topsoil and sod.
- 10. All new construction within the County right-of-way shall comply with Federal accessibility guidelines of the Americans with Disabilities Act.
- 11. For additional design guidance and other reference materials relevant to these standards, Refer to Appendix A: Technical Memorandum on Additional Design Considerations.

APPROVED:

*James A. Solby*      10/24/17  
 DIRECTOR                      DATE

REVISION DATE:	APPROVED BY:



**DEPARTMENT OF PUBLIC WORKS  
 AND TRANSPORTATION  
 Prince George's County, MD**

**Shared Street**

STD.  
 100.30



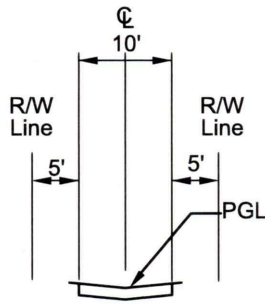

Design Speed	Subgrade (A)	Pavement Section				Min. Right-of-Way Width
		GASB Course (B)	Asphalt Base Course (C)	Intermediate Surface Course (D)	Final Surface Course (E)	
10 MPH	CBR $\geq$ 7	4"	3"	1 1/2"	1 1/2"	20'

Footnotes

- A. The top 12" of in-situ subgrade material shall have a minimum California Bearing Ratio (CBR) value of 7. See Table I-3, I-4, I-5, I-6, I-7, I-8 and I-9 of Section I "Roadway Development Guidelines" for subgrade criteria.
- B. Graded Aggregate Subbase (GASB). See Section II "Technical Specifications."
- C. Superpave Asphalt Mix (SAM) base, 19mm, PG 64S-22, Level 2. See Section II "Technical Specifications."
- D. Superpave Asphalt Mix (SAM) surface, 9.5mm, PG 64S-22, Level 2. See Section II "Technical Specifications."
- E. Superpave Asphalt Mix (SAM) surface, 9.5mm, PG 64S-22, Level 2. See Section II "Technical Specifications."

General Notes

- 1. Roadway accommodates one (1) 10-foot travel lane. Roadway dimensions are measured from edge of pavement.
- 2. Using the above design speeds, refer to AASHTO: A Policy on Geometric Design of Highways and Streets for additional horizontal and vertical design constraints.
- 3. See Section II "Technical Specifications" for materials and method of construction.
- 4. All new construction within the County right-of-way shall comply with Federal accessibility guidelines of the Americans with Disabilities Act.
- 5. For additional design guidance and other reference materials relevant to these standards, Refer to Appendix A: Technical Memorandum on Additional Design Considerations.

APPROVED:	
	10/4/17
DIRECTOR	DATE
REVISION DATE:	APPROVED BY:

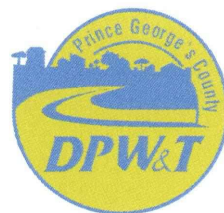

**DEPARTMENT OF PUBLIC WORKS  
AND TRANSPORTATION  
Prince George's County, MD**

Alley

STD.  
100.31

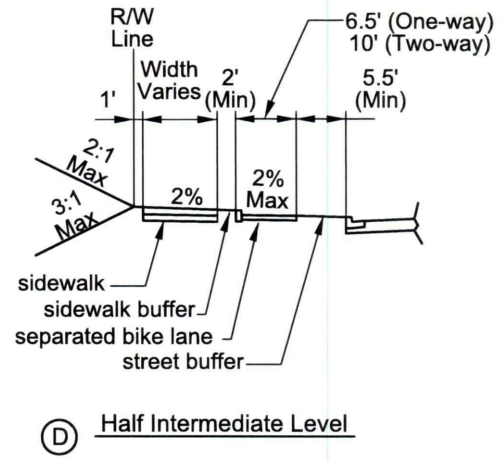
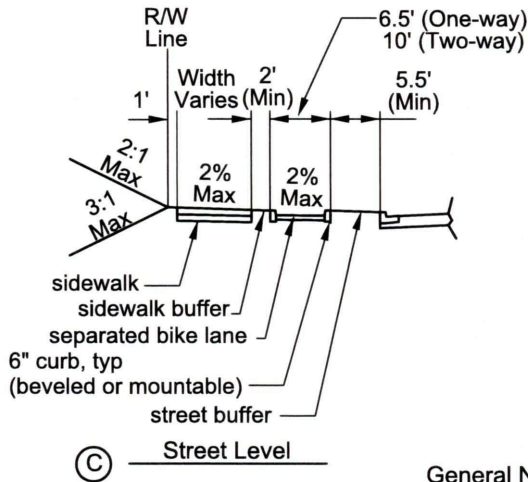
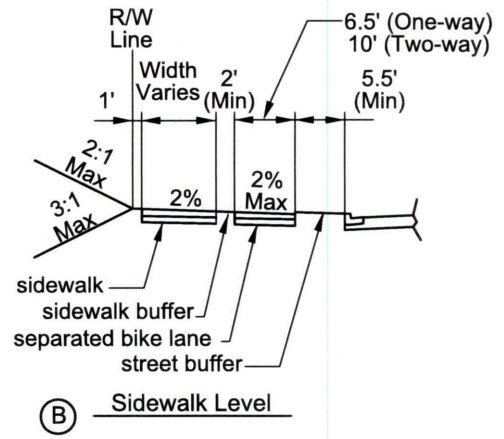
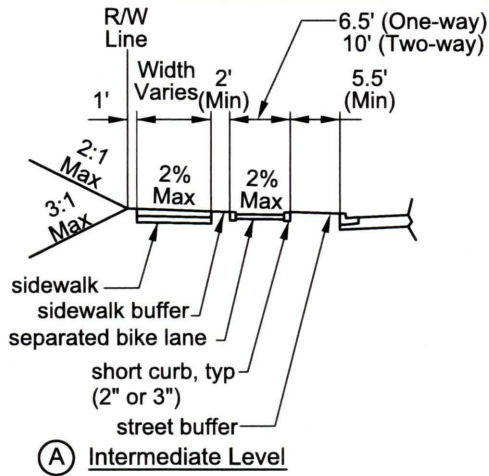

**General Notes**

1. Separated bike lanes may be flush with the sidewalk (B), flush with street (C) located at an intermediate elevation in between (A - preferred), or a combination of elevations (D).
2. For one-way separated bike lanes with low volumes of bicyclists (less than 150 per peak hour), the recommended width of the bike lane is 6.5 feet. In constrained conditions where the recommended width cannot be achieved, the bike lane can be a minimum of 5 feet wide.
3. A two-way separated bike lane may be provided on one side of the roadway. For two-way bike lanes with low volumes of bicyclists (less than 150 per peak hour), the recommended width of the bike lane between two curbs is 10 feet. In constrained conditions where the recommended width cannot be achieved, the bike lane should be a minimum of 8 feet wide. When implementing a two-way bike lane, serious consideration must be given to provide signal phase separation with a bike signal.
3. Curbs may be constructed at heights between 2" and 6". The selection of appropriate curb angle and height is an important design consideration in separated bike lanes. The curb angle - vertical, beveled or mountable - influences the crash risk to bicyclists and ease of encroachment. See detail 100.38 for short curb.
4. The street buffer and sidewalk buffer allow space for street trees, lighting, landscaping, street apputenances and/or stormwater facilities. In constrained environments, reducing or eliminating the sidewalk buffer is preferable to reducing the street buffer. It is possible to reduce the street buffer to 2'-6" wide along the roadway, but 6' must be maintained for 20' on the intersection approach for sight distance and pedestrian curb ramps.
5. Sidewalk buffer and the street buffer minimum widths can be switched as desired by designer, but street buffer should be a minimum 2.5' wide.
6. All new construction within the County right-of-way shall comply with Federal accessibility guidelines of the Americans with Disabilities Act.
7. In a road narrowing retrofit, a street level separated bike lane (C) may be achieved in a multitude of ways. Horizontal buffer and vertical barrier separation must be maintained, but the barrier could be a curb, planter, flexpost, and/or parking lane. When using a parking lane as a barrier/buffer, additional horizontal space is needed to avoid door swing of parked cars.

APPROVED:

*James S. Kelly* 10/4/17  
 DIRECTOR DATE

REVISION DATE:	APPROVED BY:

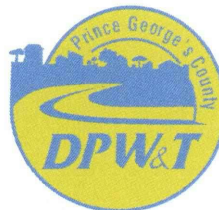

**DEPARTMENT OF PUBLIC WORKS  
 AND TRANSPORTATION  
 Prince George's County, MD**

**Separated Bike  
 Lane**

STD.  
 100.32



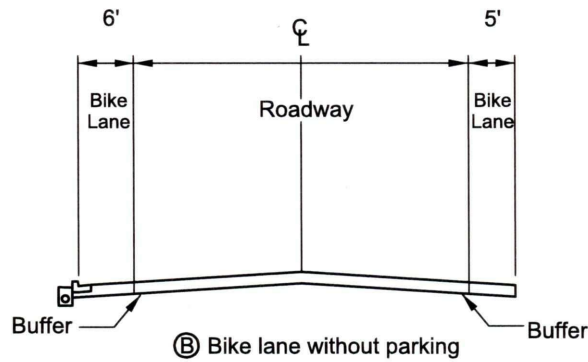
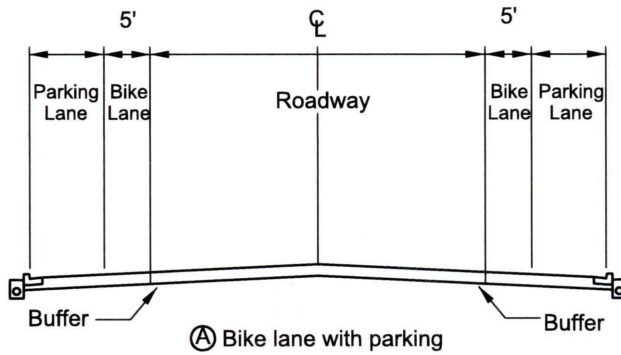

General Notes

1. If feasible and desired based on roadway characteristics, add a striped buffer between bike lane and travel lanes. Bike buffer should be a minimum of 2' wide and include 45° striped pavement markings a minimum of 10' apart. Designer can opt to include flexposts in bike buffer (10' apart) for added separation.

APPROVED:	
	10/4/17
DIRECTOR	DATE
REVISION DATE:	APPROVED BY:



**DEPARTMENT OF PUBLIC WORKS  
AND TRANSPORTATION  
Prince George's County, MD**

**Bike Lane**

STD.  
100.33

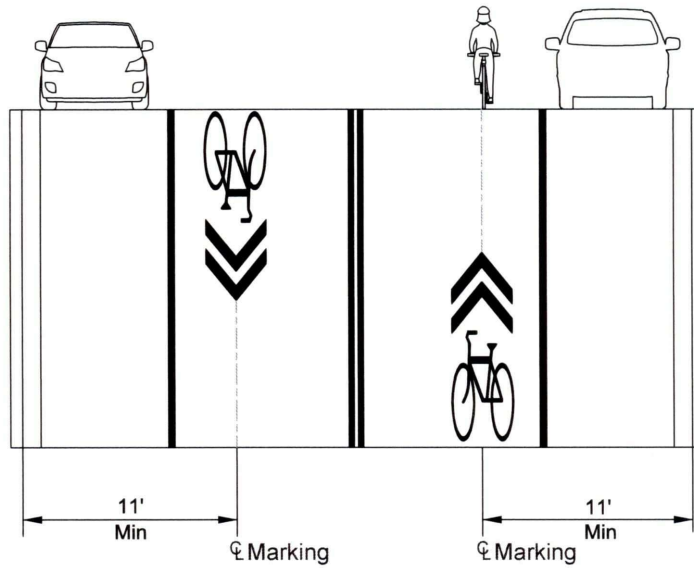

Ⓐ Shared-lane marking cross section with on street parking

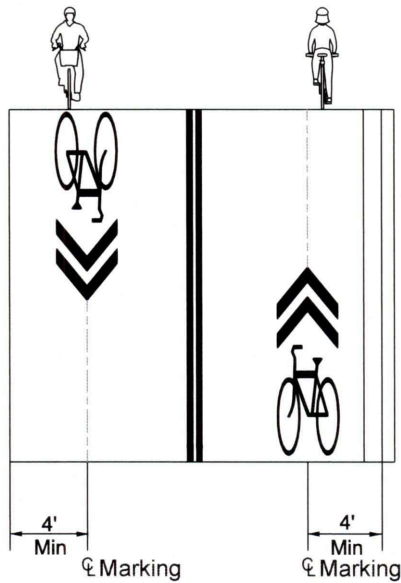

Ⓑ Shared-lane marking cross section with no on street parking

APPROVED:

*James B. Ashley* 10/4/17  
 DIRECTOR DATE

REVISION DATE:	APPROVED BY:

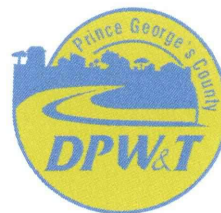

DEPARTMENT OF PUBLIC WORKS  
 AND TRANSPORTATION  
 Prince George's County, MD

Shared Lane  
 Marking

STD.  
 100.34

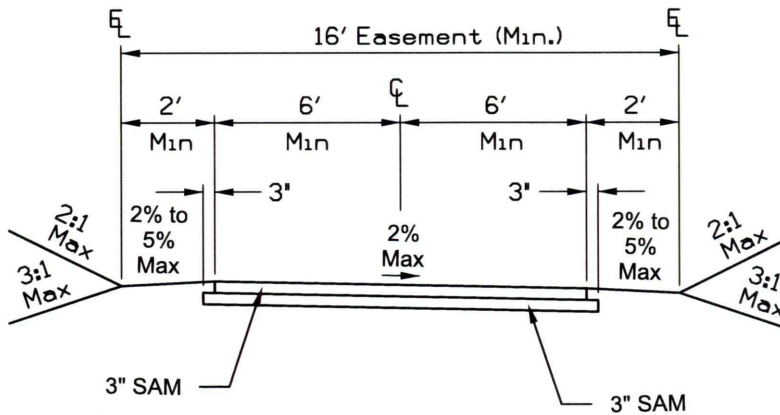

**Notes:**

1. Fill slope should typically range from 12:1 to 6:1, with a maximum slope of 3:1.
2. Easement for construction and maintenance is required where trail crosses property not in the County right-of-way.
3. ADA Cross Slope 1% recommended  
2% maximum

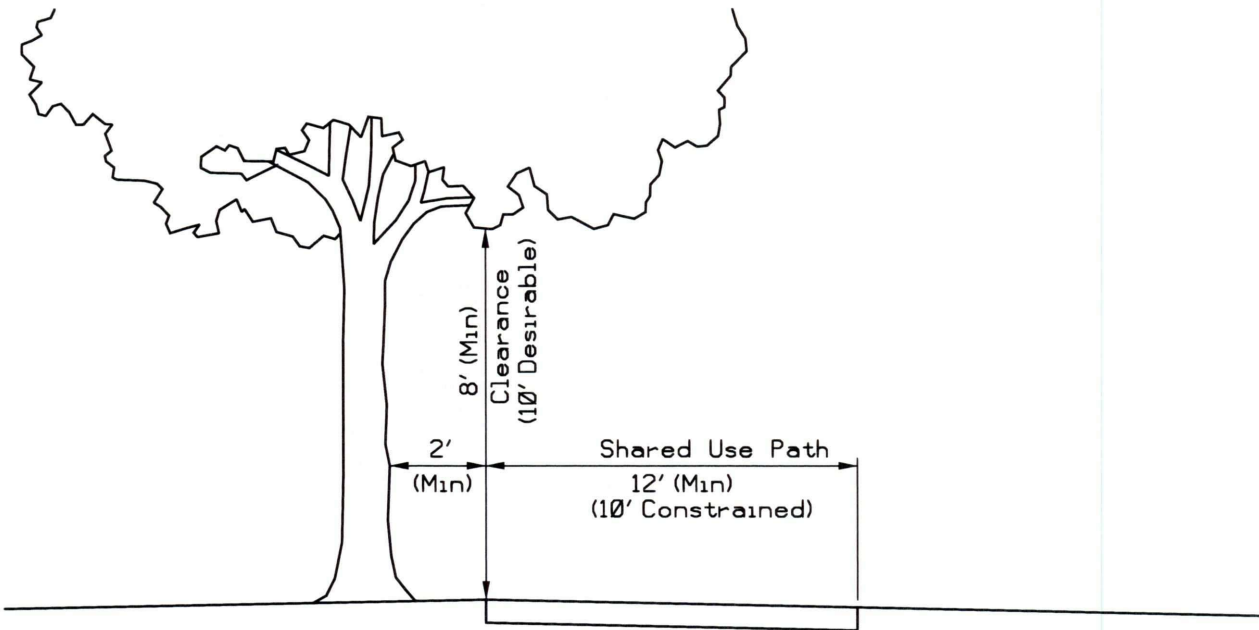

Clearance Detail

APPROVED: <i>James B. Folley</i> DIRECTOR		10/4/17 DATE		<b>DEPARTMENT OF PUBLIC WORKS AND TRANSPORTATION</b> Prince George's County, MD	
REVISION DATE:	APPROVED BY:				
				100.35	

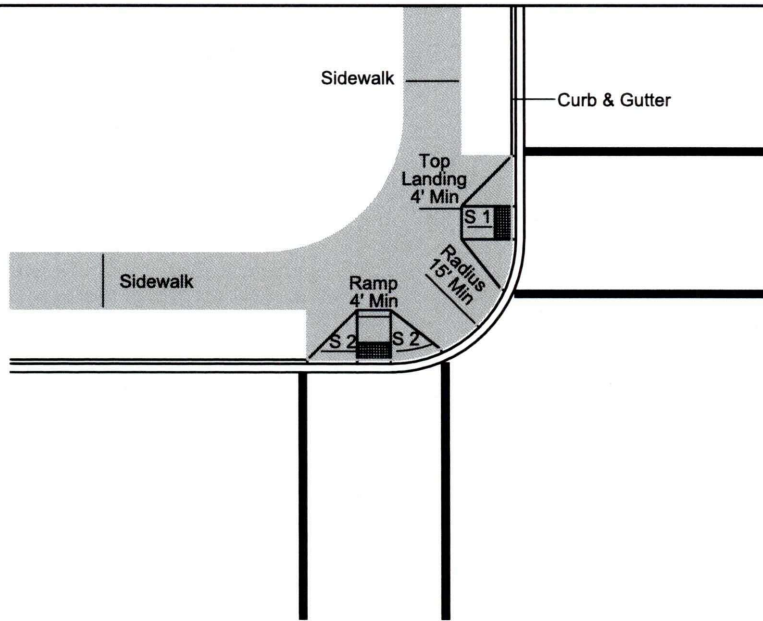

Footnotes

- A. Curb ramp slope (S 1) shall be a maximum of 12:1.
- B. Flare slope (S 2) shall be a maximum of 12:1.
- C. Top landing shall be a minimum of 4' wide with a maximum slope of 2%.
- D. Cross slopes shall not exceed 2% on landings or sidewalks.
- E. Detectable warning strip with truncated domes shall extend the full width of the ramp and extend 24 inches from the back of the curb.
- F. Ramps should be perpendicular to the curb.
- G. The ramp (not including the flare) should be located entirely within the marked crosswalk.
- H. In constrained conditions, where fixed objects or other features make it necessary to position the ramps as close to the corner as possible, there must be a curb between the two ramps with a minimum height of 3 inches and minimum width of 6 inches.

General Notes

- 1. All new construction within the County right-of-way shall comply with Federal accessibility guidelines of the Americans with Disabilities Act.
- 2a. Refer to Category 500 for street light standards.
- 2b. Refer to Category 600 for landscaping within the County right-of-way.
- 2. See Section II "Technical Specifications" for materials and method of construction.
- 3. Refer to Standards 300.01 and 300.02 for curb and gutter details.
- 4. Refer to Standards 300.05 through 300.08 for sidewalk and curb ramp details.
- 5. Refer to 300.22 and 300.23 for crosswalk standards.
- 6. When separate bike lanes are present consideration should be given to channelizing pedestrian across the bike lane with appropriate signs, markings, and pedestrian ramps. Also bicycle movements should be channelized with appropriate signs, markings, and channelizing islands.
- 7. Area between curb ramps could be landscaped with low plantings at the discretion of the designer.

APPROVED:	
	10/4/17
DIRECTOR	DATE
REVISION DATE:	APPROVED BY:



**DEPARTMENT OF PUBLIC WORKS  
AND TRANSPORTATION  
Prince George's County, MD**

<b>Perpendicular Curb Ramp Configuration</b>	STD.
	100.36



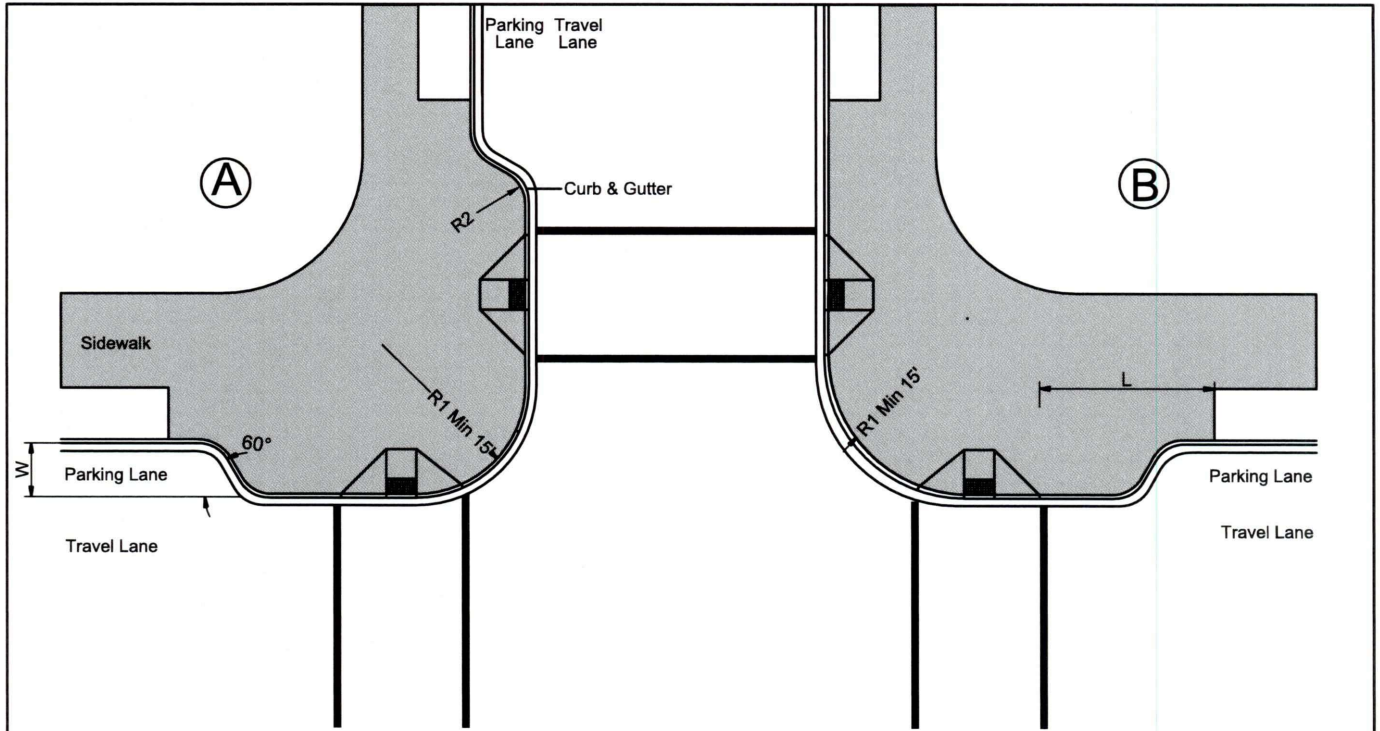

Footnotes

- A. The width (W) is equal to the width of the parking lane minus 1.5 feet.
- B. The distance between the crosswalk and the return (L) varies and should be coordinated with the drainage, streetscape, landscape, or other urban design treatments. Suggested length is 20 feet.
- C. The return angle is 60 degrees.
- D. The radius (R 2) is desirably 4 feet but may be altered to coordinate with drainage, streetscape, landscape, or other urban design treatments.
- E. Parking lanes shall be present wherever there is a curb extension.
- F. Curb extensions may be present on both sides of a corner (A) or only one side (B).

General Notes

- 1a. Refer to Category 500 for street light standards.
- 1b. Refer to Category 600 for landscaping within the County right-of-way.
- 2. See Section II "Technical Specifications" for materials and method of construction.
- 3. Refer to Standards 300.01 and 300.02 for curb and gutter details.
- 4. Refer to Standards 300.05 through 300.08 for sidewalk and curb ramp details.
- 5. Refer to 300.22 and 300.23 for crosswalk standards.
- 6. All new construction within the County right-of-way shall comply with Federal accessibility guidelines of the Americans with Disabilities Act.
- 7. When separate bike lanes are present considerations should be given to channelization pedestrians across the bike lane with appropriate signs, markings, and pedestrian ramps. Also bicycle movements should be channelized with appropriate signs markings and channelizing islands.
- 8. Area between curb ramps could be landscaped with low plantings at the discretion of the designer.

APPROVED:	
	10/24/17
DIRECTOR	DATE
REVISION DATE:	APPROVED BY:



**DEPARTMENT OF PUBLIC WORKS  
AND TRANSPORTATION  
Prince George's County, MD**

**Curb  
Extension**

**STD.  
100.37**

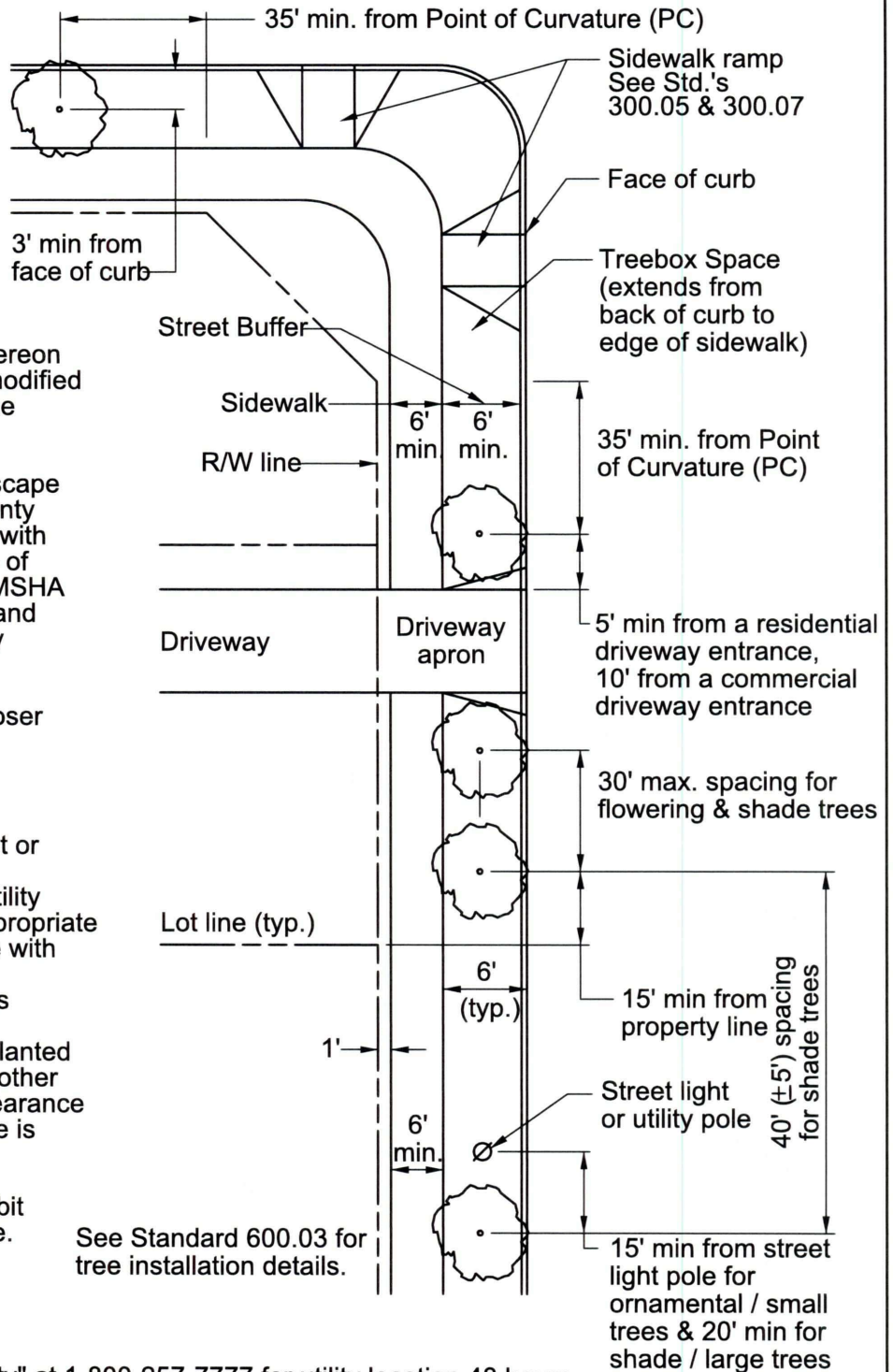

**Notes:**

1. The dimensions shown hereon are typical, and may be modified in specific situations by the Department.

For traffic safety, all landscape operations within the County right-of-way shall comply with the MSHA's maintenance of Traffic regulations. See MSHA standards MD104.31-01 and MD104.31-02 for two-way roadways.

2. Trees to be located no closer than shown:  
 - 5' from gas box  
 - 5' from water meter  
 - 5' from fire hydrant  
 - 10' from storm drain inlet or manhole  
 - 15' from street light or utility pole; and must be of appropriate height as not to interfere with overhead utility lines.  
 - 20' for shade / large trees

3. Street trees may not be planted over storm drain pipe (or other utilities) where vertical clearance from top of pipe to surface is less than 4'-6".

4. Street trees must not inhibit intersection sight distance.

See Standard 600.03 for tree installation details.

Call "Miss Utility" at 1-800-257-7777 for utility location 48 hours prior to the planting of street trees within the County right-of-way.

APPROVED: *James S. Alley* 10/4/17  
 DIRECTOR DATE

REVISION DATE: APPROVED BY:



**DEPARTMENT OF PUBLIC WORKS  
 AND TRANSPORTATION  
 Prince George's County, MD**

**Street Tree  
 Placement  
 in R/W**

**STD.  
 600.21**

# APPENDIX B: ADDITIONAL DESIGN CONSIDERATIONS RELATED TO URBAN STREET DESIGN

## Appendix B: Additional Design Considerations Related to Urban Street Design

### Turning Radius

The Urban Street Design Standards recommend a [minimum] maximum turning radius at intersection corners to reduce vehicles speeds and crash severity while improving pedestrian visibility and limiting crossing distances at intersections. Intersection design standards are adopted into these standards based on NACTO intersection design guidance from NACTO Urban Street Design Guide and NACTO Don't Give Up on the Intersection guidance. [~~However, on individual projects, the appropriate corner radius should be determined based on context sensitive design. As such, final design decisions for the turning radius must consider roadway widths, lane configurations, intersection geometry, proximity of buildings, and the design vehicle.~~] The turning radius should be designed for each intersection considering access for emergency vehicles, large trucks, transit vehicles, and school buses as appropriate. Large vehicles may present challenges related to small turning radii, particularly on narrow cross-sections (e.g. the Mixed Use Boulevard B street type.) Restrictions to parking and encroachment into adjacent and oncoming travel lanes should be considered to accommodate infrequent large vehicles turning Movements. Designing roadways for large vehicles creates an undesirable environment for pedestrians and bicyclists. The needs of all users, especially the most vulnerable, must be balanced. The designer should consider the trade-offs and design decisions that can be utilized to limit turning radii, i.e. permitting on-coming lane encroachment for infrequent large vehicles, utilizing mountable curbs, limited use of curb extensions, etc. Slip lanes are prohibited except as outlined in the procedures contained in Section 23-146(d) of the Prince George's County Code and multiple left turn lanes are strongly discouraged.

The table below can be used as a resource by designers making decisions about corner radii. The table is applicable to right turns which are typically the critical movement on two-way streets. The X axis is the available width for the turning vehicle on the receiving street and the Y axis is the available width on the approaching street. Both widths are measured from the face of the curb to the outer limits of the available area that can be used or encroached within for the swept path of the design vehicle as it turns. The figures indicate an appropriate minimum turning radius using a WB-40 design vehicle (which is slightly larger than a standard transit bus). The WB-40 is a commonly used design vehicle for most situations in cities. For streets with on-street parking, the radius provided using the chart will represent the effective radius, not the actual radius. The chart can still be used but, instead of the available space beginning at the face of the curb, it would start at the edge of the parking aisle.

This chart is not applicable to skewed intersections and when there is a desire to use compound curves instead of a simple radii. Similarly, streets in industrial areas or with significant bus activity may require a particularly tailored approach, for example using a different design vehicle if trucks typically exceed the size of the WB-40, modifying the placement of stop bars, or adjusting the assumptions about encroachment. While this table does not provide definitive turning radii that are applicable to all conditions, it can be a useful tool that informs the design process.



Radii of Face of Curb	Receiving Width (measured from face of curb) in feet																												
	10	11	11.5	12	13	14	15	16	16.5	17	18	19	20	21	21.5	22	23	24	25	26	26.5	27	28	29	30				
10	95	75	70	65	55	40	40	35	35	35	30	30	25	25	20	20	20	20	15	15	15	15	15	10	10				
11	90	70	70	60	55	40	40	35	35	35	30	25	25	20	20	20	20	15	15	15	15	15	10	10	10				
11.5	90	70	65	60	55	40	40	35	35	35	30	25	25	20	20	20	20	15	15	15	15	15	10	10	10				
12	90	70	65	60	55	45	40	35	35	30	30	25	25	20	20	20	20	15	15	15	15	10	10	10	10				
13	90	70	65	60	50	45	40	35	35	30	25	25	20	20	20	20	15	15	15	15	10	10	10	10	10				
14	90	70	65	60	50	45	40	35	30	30	25	25	20	20	20	20	15	15	15	10	10	10	10	10	5				
15	85	70	60	55	40	45	35	35	30	30	25	25	20	20	15	15	15	15	10	10	10	10	10	10	5				
16	85	70	60	55	40	45	35	30	30	30	25	20	20	15	15	15	15	15	10	10	10	10	10	5	5				
Approach Width (measured from face of curb) in feet	16.5	85	70	60	55	40	45	35	30	30	30	25	20	20	15	15	15	15	10	10	10	10	10	5	5				
	17	85	70	60	55	40	45	35	30	30	30	25	25	20	20	15	15	15	15	10	10	10	10	5	5				
	18	85	65	60	55	40	45	35	30	30	25	20	20	15	15	15	15	10	10	10	10	10	5	5					
	19	85	65	60	55	45	40	35	30	25	25	20	20	15	15	15	15	10	10	10	5	5	5	5					
	20	85	65	55	60	45	40	30	25	25	20	20	15	15	10	10	10	10	5	5	5	5	5	0	0				
	21	80	60	55	60	45	40	30	25	25	20	20	15	15	10	10	10	10	5	5	5	0	0	0	0				
	21.5	80	60	55	60	45	35	30	25	25	20	20	15	15	10	10	10	10	5	5	5	5	0	0	0				
	22	80	60	55	60	45	35	30	25	25	20	20	15	15	10	10	10	10	5	5	5	0	0	0	0				
	23	80	60	55	60	45	35	30	25	25	20	20	15	15	10	10	10	10	5	5	0	0	0	0	0				
	24	80	60	55	60	40	35	25	25	20	20	15	15	10	10	10	10	5	5	0	0	0	0	0	0				
	25	80	60	55	45	40	35	25	20	20	20	15	15	10	10	10	5	5	5	0	0	0	0	0	0				
	26	75	60	60	45	40	35	25	20	20	20	15	10	10	10	5	5	5	0	0	0	0	0	0	0				
	26.5	75	60	60	45	40	30	25	20	20	15	15	10	10	5	5	5	5	0	0	0	0	0	0	0				
	27	75	60	60	45	40	30	25	20	20	15	15	10	10	5	5	5	5	0	0	0	0	0	0	0				
	28	75	55	60	45	35	30	25	20	20	15	10	10	5	5	5	5	0	0	0	0	0	0	0	0				
	29	75	55	60	45	35	30	20	20	15	15	10	10	5	5	5	0	0	0	0	0	0	0	0	0				
	30	75	55	60	45	35	30	20	15	15	15	10	10	5	5	0	0	0	0	0	0	0	0	0	0				

Figure 1. Turning Radius Design Resource (compiled from ITE Turning Vehicle Template, 2000)

### Designing Bike Lanes at Intersections

Bike lanes are intended to encourage bicyclists to ride on the roadway in a position and manner that makes them most visible to motorists entering or exiting the roadway and that is consistent with legal and effective operation of a vehicle. Good intersection design indicates to bicyclists and motorists how they should traverse the intersection; as such, all bike lanes at intersections should provide clear and logical direction to all users. These principles also hold true for separated bike lanes at intersections. For additional guidance on bike lane designs at intersections, consult the AASHTO Guide for the Development of Bicycle Facilities, the NACTO Urban Bikeway Design Guide, and the Manual on Uniform Traffic Control Devices (MUTCD). For more information on separated bike lane design at intersections, consult the FHWA Separated Bike Lane Planning and Design Guide and the MassDOT Separated Bike Lane Planning & Design Guide.

### Fire Code Compliance

The Fire Safety Law of Prince George’s County (Prince George’s County Code of Ordinances – Subtitle 11), as supplemented by the National Fire Protection Association (NFPA) model codes or standard promulgations, provides the design requirements for public and private street design. Street clear widths are an important design consideration related to fire department access. Consistent with the NFPA, public roadways must provide a 20’ clear width to accommodate access for fire apparatus. This clear width is accommodated on all street types in the Prince George’s County Urban Street Standards except for the Mixed Use Boulevard (A) with two travel lanes. The previous exception would only provide 18’ of clear width and only 10’ in areas where parking is allowed. To remedy this, it is advised that sufficient alternative measures should be designed into the median and roadway of any permitted road to allow for 20’ of width. These measures could include no parking 50’ from hydrants, mountable curbs and reinforced medians in areas where parking is allowed, no parking where median features prevent apparatus from crossing over, etc.

## Other Design Resources

There are a variety of valuable reference and resources that designers should use in conjunction with the Prince George's County Urban Street Design Standards. The following is a lists of some key reference materials:

- AASHTO A Policy on Geometric Design of Highways and Streets (AASHTO Green Book)
- AASHTO Guide for the Planning, Design, and Operation of Pedestrian Facilities
- AASHTO Guide for the Development of Bicycle Facilities
- Manual on Uniform Traffic Control Devices for Streets and Highways (MUTCD)
- FHWA Flexibility in Highway Design
- FHWA Separated Bike Lane Planning and Design Guide
- Maryland Department of Transportation Level of Traffic Stress (LTS) Methodology
- NACTO Urban Street Design Guide
- NACTO Urban Bikeway Design Guide
- NACTO Transit Street Design Guide
- NACTO Don't Give Up on the Intersection
- NACTO City Limits: Setting Safe Speed Limits on Urban Streets
- NCHRP Report 672 – Roundabouts: An Informational Guide
- NCHRP Report 766 – Recommended Bicycle Lane Widths for Various Roadway Characteristics